



Reusable SpO2 Sensor



U401-D(02AL-E)

- Finger type**
- A:P series adult clip; B:Adult soft tip; C:Pediartic clip;
- D:Pediatric soft tip; E:Infant soft tip; F:Neonate wrap;
- G:Neonate "Y" type; H:Adult ear clip; J:Veterinary tongue;
- L:Envitec finger shell; M:Dolphin finger shell;
- N:Nellcor finger shell; P:White&Black ear clip;
- Q:White&Black "Y" type; R:UU Panda finger shell;
- Length (L:2.8m; S:0.9m; G:Original longer length; H:Original shorter length)
- Compatible model No (A:the first type;B: the second type...)
- Compatible brand No (01: (Nellcor) ; 02:GE;03:Mindray...)
- Product registered No (U401-A:Adult clip; U401-B:Adult soft tip; U401-D:Pediatric soft tip; D included E, F and G type; A included H, J,K,M and N type;B included all soft tip type)
- UpnMed

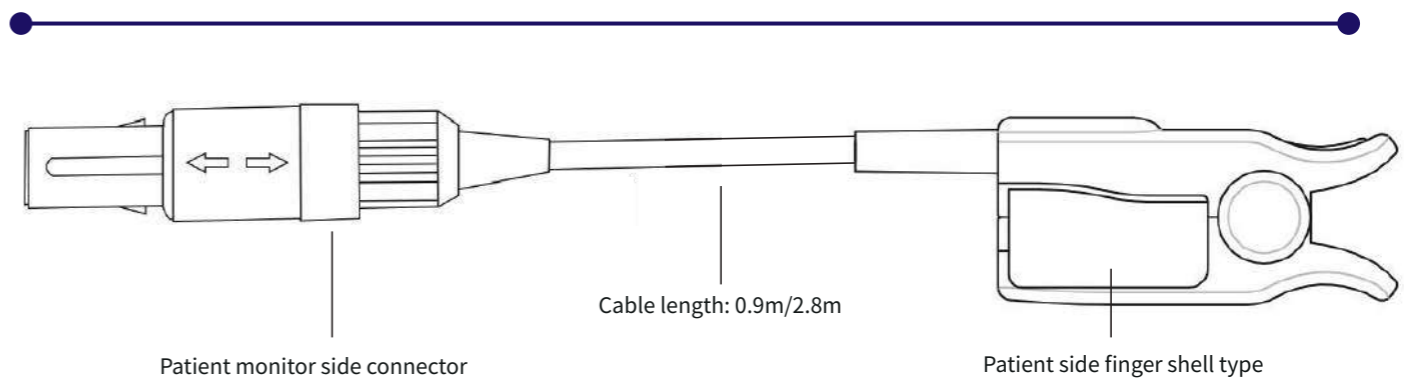
For example:
 U401-A (01AS-R) Reusable Adult Clip SpO2 Sensor for Nellcor, 0.9M
 U401-D (02AL-E) Reusable Infant soft tip SpO2 Sensor for GE, 2.8M



PROBE TYPE (O2)

- | | |
|--|---|
| 
R
UU Panda Adult Finger Clip Shell
Application: Adult > 40kgs | 
A
P series Adult Finger Clip Shell
Application: Adult > 40kgs |
| 
L
Envitec Adult Finger Clip Shell
Application: Adult > 40kgs | 
M
Dolphin Adult Finger Clip Shell
Application: Adult > 40kgs |
| 
N
Nellcor Adult Finger Clip Shell
Application: Adult > 40kgs | 
B
Adult Soft Rubber
Application: Adult > 40kgs |
| 
C
Pediatric Finger Clip
Application: Pediatric 10-40kgs | 
D
Pediatric Soft Rubber
Application: Pediatric 10-40kgs |
| 
E
Infant Soft Rubber
Application: Infant 3-15kgs | 
F
Neonate Wrap Rubber
Application: Neonate 1-4kgs |
| 
G
Neonate "Y" type
Application: Neonate 1-4kgs | 
H
Adult Ear Clip
Application: Adult > 40kgs |
| 
J
Veterinary Clip
Application: Dog, Cat... | 
Q
Neonate "Y" type
Application: Neonate 1-4kgs |







C~C

Brand/Compatible Models	P/N	Description	Male Connector
Comen (8 pin)			
C60, C80 (Nelcor + Oximax tech)	U401-A(38EL)	Adult finger clip, 2.8m	
	U401-B(38EL)	Adult silicone soft tip, 2.8m	
	U401-C(38EL)	Pediatric finger clip, 2.8m	
	U401-D(38EL)	Pediatric silicone soft tip, 2.8m	
	U401-E(38EL)	Infant silicone soft tip, 2.8m	
	U401-F(38EL)	Neonate silicone wrap, 2.8m	
	U401-G(38EL)	Neonate "Y" type, 2.8m	
	U401-H(38EL)	Adult ear clip, 2.8m	
	U401-A(38FL)	Adult finger clip, 2.8m	
	U401-B(38FL)	Adult silicone soft tip, 2.8m	
	U401-C(38FL)	Pediatric finger clip, 2.8m	
	U401-D(38FL)	Pediatric silicone soft tip, 2.8m	
U401-E(38FL)	Infant silicone soft tip, 2.8m		
U401-F(38FL)	Neonate silicone wrap, 2.8m		
U401-G(38FL)	Neonate "Y" type, 2.8m		
U401-H(38FL)	Adult ear clip, 2.8m		
Comen (12 pin)			
C50, C30, C80 (Digital Tech)	U401-A(38GL)	Adult finger clip, 2.8m	
	U401-B(38GL)	Adult silicone soft tip, 2.8m	
	U401-C(38GL)	Pediatric finger clip, 2.8m	
	U401-D(38GL)	Pediatric silicone soft tip, 2.8m	
	U401-E(38GL)	Infant silicone soft tip, 2.8m	
	U401-F(38GL)	Neonate silicone wrap, 2.8m	
U401-G(38GL)	Neonate "Y" type, 2.8m		
U401-H(38GL)	Adult ear clip, 2.8m		
Comen (12 pin)			
C30 (Masimo + Oximax tech)	U401-A(38JL)	Adult finger clip, 2.8m	
	U401-B(38JL)	Adult silicone soft tip, 2.8m	
	U401-C(38JL)	Pediatric finger clip, 2.8m	
	U401-D(38JL)	Pediatric silicone soft tip, 2.8m	
	U401-E(38JL)	Infant silicone soft tip, 2.8m	
	U401-F(38JL)	Neonate silicone wrap, 2.8m	
U401-G(38JL)	Neonate "Y" type, 2.8m		
U401-H(38JL)	Adult ear clip, 2.8m		
Comen (12 pin)			
NC8A (Analog)	U401-A(38LL)	Adult finger clip, 2.8m	
	U401-B(38LL)	Adult silicone soft tip, 2.8m	
	U401-C(38LL)	Pediatric finger clip, 2.8m	
	U401-D(38LL)	Pediatric silicone soft tip, 2.8m	
	U401-E(38LL)	Infant silicone soft tip, 2.8m	
	U401-F(38LL)	Neonate silicone wrap, 2.8m	
	U401-G(38LL)	Neonate "Y" type, 2.8m	
	U401-H(38LL)	Adult ear clip, 2.8m	
Comen (8 pin 40°)			
C60 (Masimo + Oximax tech)	U401-A(38KL)	Adult finger clip, 2.8m	
	U401-B(38KL)	Adult silicone soft tip, 2.8m	
	U401-C(38KL)	Pediatric finger clip, 2.8m	
	U401-D(38KL)	Pediatric silicone soft tip, 2.8m	
	U401-E(38KL)	Infant silicone soft tip, 2.8m	
	U401-F(38KL)	Neonate silicone wrap, 2.8m	
	U401-G(38KL)	Neonate "Y" type, 2.8m	
	U401-H(38KL)	Adult ear clip, 2.8m	
Comen (6 pin 60°)			
Star 5000 (Digital Tech)	U401-A(38NL)	Adult finger clip, 2.8m	
	U401-B(38NL)	Adult silicone soft tip, 2.8m	
	U401-C(38NL)	Pediatric finger clip, 2.8m	
	U401-D(38NL)	Pediatric silicone soft tip, 2.8m	
	U401-E(38NL)	Infant silicone soft tip, 2.8m	
	U401-F(38NL)	Neonate silicone wrap, 2.8m	
	U401-G(38NL)	Neonate "Y" type, 2.8m	
	U401-H(38NL)	Adult ear clip, 2.8m	
Contec (5 pin)			
(Digital Tech)	U401-A(48AL)	Adult finger clip, 2.8m	
	U401-B(48AL)	Adult silicone soft tip, 2.8m	
	U401-C(48AL)	Pediatric finger clip, 2.8m	
	U401-D(48AL)	Pediatric silicone soft tip, 2.8m	
	U401-E(48AL)	Infant silicone soft tip, 2.8m	
	U401-F(48AL)	Neonate silicone wrap, 2.8m	
U401-G(48AL)	Neonate "Y" type, 2.8m		
U401-H(48AL)	Adult ear clip, 2.8m		
Contec (6 pin 40°)			
CMS9000, CMS8000	U401-A(48CL)	Adult finger clip, 2.8m	
	U401-B(48CL)	Adult silicone soft tip, 2.8m	
	U401-C(48CL)	Pediatric finger clip, 2.8m	
	U401-D(48CL)	Pediatric silicone soft tip, 2.8m	
	U401-E(48CL)	Infant silicone soft tip, 2.8m	
	U401-F(48CL)	Neonate silicone wrap, 2.8m	
	U401-G(48CL)	Neonate "Y" type, 2.8m	
	U401-H(48CL)	Adult ear clip, 2.8m	

Brand/Compatible Models	P/N	Description	Male Connector
Contec (7 pin)			
CMS8000 (Digital Tech)	U401-A(48DS)	Adult finger clip, 0.9m	
	U401-B(48DS)	Adult silicone soft tip, 0.9m	
	U401-C(48DS)	Pediatric finger clip, 0.9m	
	U401-D(48DS)	Pediatric silicone soft tip, 0.9m	
	U401-E(48DS)	Infant silicone soft tip, 0.9m	
	U401-F(48DS)	Neonate silicone wrap, 0.9m	
	U401-G(48DS)	Neonate "Y" type, 0.9m	
	U401-H(48DS)	Adult ear clip, 0.9m	
Contec (5 pin)			
LSR200 (Digital Tech)	U401-A(48EL)	Adult finger clip, 2.8m	
	U401-B(48EL)	Adult silicone soft tip, 2.8m	
	U401-C(48EL)	Pediatric finger clip, 2.8m	
	U401-D(48EL)	Pediatric silicone soft tip, 2.8m	
	U401-E(48EL)	Infant silicone soft tip, 2.8m	
	U401-F(48EL)	Neonate silicone wrap, 2.8m	
	U401-G(48EL)	Neonate "Y" type, 2.8m	
	U401-H(48EL)	Adult ear clip, 2.8m	
Contec (7 pin)			
LSR200 (Digital Tech)	U401-A(48FS)	Adult finger clip, 0.9m	
	U401-B(48FS)	Adult silicone soft tip, 0.9m	
	U401-C(48FS)	Pediatric finger clip, 0.9m	
	U401-D(48FS)	Pediatric silicone soft tip, 0.9m	
	U401-E(48FS)	Infant silicone soft tip, 0.9m	
	U401-F(48FS)	Neonate silicone wrap, 0.9m	
	U401-G(48FS)	Neonate "Y" type, 0.9m	
	U401-H(48FS)	Adult ear clip, 0.9m	
Creative (5 pin 80°)			
(Digital Tech)	U401-A(10AL)	Adult finger clip, 2.8m	
	U401-B(10AL)	Adult silicone soft tip, 2.8m	
	U401-C(10AL)	Pediatric finger clip, 2.8m	
	U401-D(10AL)	Pediatric silicone soft tip, 2.8m	
	U401-E(10AL)	Infant silicone soft tip, 2.8m	
	U401-F(10AL)	Neonate silicone wrap, 2.8m	
	U401-G(10AL)	Neonate "Y" type, 2.8m	
	U401-H(10AL)	Adult ear clip, 2.8m	
Creative (6 pin 40°)			
Creative: PC9000, UP6000, TOB-MED: TOM MS-6-P Edan: M9 BIOCCARE: BM9000 Glowday Contec	U401-A(10BL)	Adult finger clip, 2.8m	
	U401-B(10BL)	Adult silicone soft tip, 2.8m	
	U401-C(10BL)	Pediatric finger clip, 2.8m	
	U401-D(10BL)	Pediatric silicone soft tip, 2.8m	
	U401-E(10BL)	Infant silicone soft tip, 2.8m	
	U401-F(10BL)	Neonate silicone wrap, 2.8m	
	U401-G(10BL)	Neonate "Y" type, 2.8m	
	U401-H(10BL)	Adult ear clip, 2.8m	
	U401-A(10CS)	Adult finger clip, 0.9m	
	U401-B(10CS)	Adult silicone soft tip, 0.9m	
	U401-C(10CS)	Pediatric finger clip, 0.9m	
	U401-D(10CS)	Pediatric silicone soft tip, 0.9m	
U401-E(10CS)	Infant silicone soft tip, 0.9m		
U401-F(10CS)	Neonate silicone wrap, 0.9m		
U401-G(10CS)	Neonate "Y" type, 0.9m		
U401-H(10CS)	Adult ear clip, 0.9m		
Creative (8 pin)			
(Oximax tech)	U401-A(10DL)	Adult finger clip, 2.8m	
	U401-B(10DL)	Adult silicone soft tip, 2.8m	
	U401-C(10DL)	Pediatric finger clip, 2.8m	
	U401-D(10DL)	Pediatric silicone soft tip, 2.8m	
	U401-E(10DL)	Infant silicone soft tip, 2.8m	
	U401-F(10DL)	Neonate silicone wrap, 2.8m	
	U401-G(10DL)	Neonate "Y" type, 2.8m	
	U401-H(10DL)	Adult ear clip, 2.8m	
Creative (6 pin 40°)			
PC-5000A (Oximax tech)	U401-A(10EL)	Adult finger clip, 2.8m	
	U401-B(10EL)	Adult silicone soft tip, 2.8m	
	U401-C(10EL)	Pediatric finger clip, 2.8m	
	U401-D(10EL)	Pediatric silicone soft tip, 2.8m	
	U401-E(10EL)	Infant silicone soft tip, 2.8m	
	U401-F(10EL)	Neonate silicone wrap, 2.8m	
	U401-G(10EL)	Neonate "Y" type, 2.8m	
	U401-H(10EL)	Adult ear clip, 2.8m	
Choice (5 pin)			
MMED6000/D, Anke: 553/Glowday U T5000/Want dong/TianRong/ Baozhong/Oliant/M-III/Jerry/PM2000/ Mindray/PM9000/Richer/RC9000/She nmaik/P900	U401-A(70AL)	Adult finger clip, 2.8m	
	U401-B(70AL)	Adult silicone soft tip, 2.8m	
	U401-C(70AL)	Pediatric finger clip, 2.8m	
	U401-D(70AL)	Pediatric silicone soft tip, 2.8m	
	U401-E(70AL)	Infant silicone soft tip, 2.8m	
	U401-F(70AL)	Neonate silicone wrap, 2.8m	
	U401-G(70AL)	Neonate "Y" type, 2.8m	
	U401-H(70AL)	Adult ear clip, 2.8m	
	U401-A(70BL)	Adult finger clip, 0.9m	
	U401-B(70BL)	Adult silicone soft tip, 0.9m	
	U401-C(70BL)	Pediatric finger clip, 0.9m	
	U401-D(70BL)	Pediatric silicone soft tip, 0.9m	

Brand/Compatible Models	P/N	Description	Male Connector
Choice (6 pin)			
	U401-A(70BL)	Adult finger clip, 2.8m	
	U401-B(70BL)	Adult silicone soft tip, 2.8m	
	U401-C(70BL)	Pediatric finger clip, 2.8m	
	U401-D(70BL)	Pediatric silicone soft tip, 2.8m	
	U401-E(70BL)	Infant silicone soft tip, 2.8m	
	U401-F(70BL)	Neonate silicone wrap, 2.8m	
	U401-G(70BL)	Neonate "Y" type, 2.8m	
	U401-H(70BL)	Adult ear clip, 2.8m	
	U401-A(70GL)	Adult finger clip, 2.8m	
	U401-B(70GL)	Adult silicone soft tip, 2.8m	
	U401-C(70GL)	Pediatric finger clip, 2.8m	
	U401-D(70GL)	Pediatric silicone soft tip, 2.8m	
U401-E(70GL)	Infant silicone soft tip, 2.8m		
U401-F(70GL)	Neonate silicone wrap, 2.8m		
U401-G(70GL)	Neonate "Y" type, 2.8m		
U401-H(70GL)	Adult ear clip, 2.8m		
Choice (6 pin 40°)			
(Digital Tech)	U401-A(70DL)	Adult finger clip, 2.8m	
	U401-B(70DL)	Adult silicone soft tip, 2.8m	
	U401-C(70DL)	Pediatric finger clip, 2.8m	
	U401-D(70DL)	Pediatric silicone soft tip, 2.8m	
	U401-E(70DL)	Infant silicone soft tip, 2.8m	
	U401-F(70DL)	Neonate silicone wrap, 2.8m	
	U401-G(70DL)	Neonate "Y" type, 2.8m	
	U401-H(70DL)	Adult ear clip, 2.8m	
	U401-A(70DS)	Adult finger clip, 0.9m	
	U401-B(70DS)	Adult silicone soft tip, 0.9m	
	U401-C(70DS)	Pediatric finger clip, 0.9m	
	U401-D(70DS)	Pediatric silicone soft tip, 0.9m	
U401-E(70DS)	Infant silicone soft tip, 0.9m		
U401-F(70DS)	Neonate silicone wrap, 0.9m		
U401-G(70DS)	Neonate "Y" type, 0.9m		
U401-H(70DS)	Adult ear clip, 0.9m		
Choice (9 pin)			
(Digital Tech)	U401-A(70EL)	Adult finger clip, 2.8m	
	U401-B(70EL)	Adult silicone soft tip, 2.8m	
	U401-C(70EL)	Pediatric finger clip, 2.8m	
	U401-D(70EL)	Pediatric silicone soft tip, 2.8m	
	U401-E(70EL)	Infant silicone soft tip, 2.8m	
	U401-F(70EL)	Neonate silicone wrap, 2.8m	
	U401-G(70EL)	Neonate "Y" type, 2.8m	
	U401-H(70EL)	Adult ear clip, 2.8m	
	U401-A(70ES)	Adult finger clip, 0.9m	
	U401-B(70ES)	Adult silicone soft tip, 0.9m	
	U401-C(70ES)	Pediatric finger clip, 0.9m	
	U401-D(70ES)	Pediatric silicone soft tip, 0.9m	
U401-E(70ES)	Infant silicone soft tip, 0.9m		
U401-F(70ES)	Neonate silicone wrap, 0.9m		
U401-G(70ES)	Neonate "Y" type, 0.9m		
U401-H(70ES)	Adult ear clip, 0.9m		
Choice (9 pin)			
(Oximax tech)	U401-A(70FL)	Adult finger clip, 2.8m	
	U401-B(70FL)	Adult silicone soft tip, 2.8m	
	U401-C(70FL)	Pediatric finger clip, 2.8m	
	U401-D(70FL)	Pediatric silicone soft tip, 2.8m	
	U401-E(70FL)	Infant silicone soft tip, 2.8m	
	U401-F(70FL)	Neonate silicone wrap, 2.8m	
	U401-G(70FL)	Neonate "Y" type, 2.8m	
	U401-H(70FL)	Adult ear clip, 2.8m	
	U401-A(70FS)	Adult finger clip, 0.9m	
	U401-B(70FS)	Adult silicone soft tip, 0.9m	
	U401-C(70FS)	Pediatric finger clip, 0.9m	
	U401-D(70FS)	Pediatric silicone soft tip, 0.9m	
U401-E(70FS)	Infant silicone soft tip, 0.9m		
U401-F(70FS)	Neonate silicone wrap, 0.9m		
U401-G(70FS)	Neonate "Y" type, 0.9m		
U401-H(70FS)	Adult ear clip, 0.9m		
Choice (9 pin)			
	U401-A(70FL)	Adult finger clip, 2.8m	
	U401-B(70FL)	Adult silicone soft tip, 2.8m	
	U401-C(70FL)	Pediatric finger clip, 2.8m	
	U401-D(70FL)	Pediatric silicone soft tip, 2.8m	
	U401-E(70FL)	Infant silicone soft tip, 2.8m	
	U401-F(70FL)	Neonate silicone wrap, 2.8m	
	U401-G(70FL)	Neonate "Y" type, 2.8m	
	U401-H(70FL)	Adult ear clip, 2.8m	
	U401-A(70FL)	Adult finger clip, 0.9m	
	U401-B(70FL)	Adult silicone soft tip, 0.9m	
	U401-C(70FL)	Pediatric finger clip, 0.9m	
	U401-D(70FL)	Pediatric silicone soft tip, 0.9m	
U401-E(70FL)	Infant silicone soft tip, 0.9m		
U401-F(70FL)	Neonate silicone wrap, 0.9m		
U401-G(70FL)	Neonate "Y" type, 0.9m		
U401-H(70FL)	Adult ear clip, 0.9m		
Charmcare (9 pin)			
	U401-A(84AL)	Adult finger clip, 2.8m	
	U401-B(84AL)	Adult silicone soft tip, 2.8m	
	U401-C(84AL)	Pediatric finger clip, 2.8m	
	U401-D(84AL)	Pediatric silicone soft tip, 2.8m	
	U401-E(84AL)	Infant silicone soft tip, 2.8m	
	U401-F(84AL)	Neonate silicone wrap, 2.8m	
	U401-G(84AL)	Neonate "Y" type, 2.8m	
	U401-H(84AL)	Adult ear clip, 2.8m	
	U401-A(84AS)	Adult finger clip, 0.9m	
	U401-B(84AS)	Adult silicone soft tip, 0.9m	
	U401-C(84AS)	Pediatric finger clip, 0.9m	
	U401-D(84AS)	Pediatric silicone soft tip, 0.9m	
U401-E(84AS)	Infant silicone soft tip, 0.9m		
U401-F(84AS)	Neonate silicone wrap, 0.9m		
U401-G(84AS)	Neonate "Y" type, 0.9m		
U401-H(84AS)	Adult ear clip, 0.9m		
Critikon (7 pin)			
Dinamap 8700/8710/8721/9700/9710/ 8280/8720 plus	U401-A(33AL)	Adult finger clip, 2.8m	
	U401-B(33AL)	Adult silicone soft tip, 2.8m	
	U401-C(33AL)	Pediatric finger clip, 2.8m	
	U401-D(33AL)	Pediatric silicone soft tip, 2.8m	
	U401-E(33AL)	Infant silicone soft tip, 2.8m	
	U401-F(33AL)	Neonate silicone wrap, 2.8m	
	U401-G(33AL)	Neonate "Y" type, 2.8m	
	U401-H(33AL)	Adult ear clip, 2.8m	
	U401-A(33AL)	Adult finger clip, 0.9m	
	U401-B(33AL)	Adult silicone soft tip, 0.9m	
	U401-C(33AL)	Pediatric finger clip, 0.9m	
	U401-D(33AL)	Pediatric silicone soft tip, 0.9m	

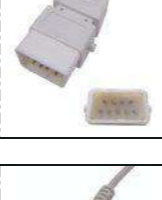
Brand/Compatible Models	P/N	Description	Male Connector
Colin (14 pin)			
	U401-A(41DL)	Adult finger clip,2.8m	
	U401-B(41DL)	Adult silicone soft tip,2.8m	
	U401-C(41DL)	Pediatric finger clip,2.8m	
BX 10NE (Oximax tech)	U401-D(41DL)	Pediatric silicone soft tip,2.8m	
	U401-D(41DL-E)	Infant silicone soft tip,2.8m	
	U401-D(41DL-F)	Neonate silicone wrap,2.8m	
	U401-D(41DL-G)	Neonate "Y" type,2.8m	
U401-A(41DL-H)	Adult ear clip,2.8m		
Datex Ohmeda (8 pin)			
Ohmeda TruSat 3755, TruSat TD, series 37XX, 3800, 3900, 3900P, 5700, 5250, Cardiocap 5, S/5, AS/3, CS/4 (M-OSAT).(Need extension cable)	U401-A(06AS)	Adult finger clip,0.9m	
	U401-B(06AS)	Adult silicone soft tip,0.9m	
	U401-C(06AS)	Pediatric finger clip,0.9m	
	U401-D(06AS)	Pediatric silicone soft tip,0.9m	
	U401-D(06AS-E)	Infant silicone soft tip,0.9m	
	U401-D(06AS-F)	Neonate silicone wrap,0.9m	
	U401-D(06AS-G)	Neonate "Y" type,0.9m	
	U401-A(06AS-H)	Adult ear clip,0.9m	
Datex Ohmeda (9 pin)			
Datex/AS/3, CS/3, CH/S, CH/2S, CH-RS, CG/2S, Cardiocap I, Cardiocap II, Cardiocap 5, Capnomac Ultima, Light Monitor, M-Estrp, Oscar II, OSP-200, Satellite Trans, Satellite Trans Plus, System 5, ULTS50, ULTSIO, ULTSVI, ULTSVOC, OEM-SAF-F5 (Datex tech)	U401-A(06BS)	Adult finger clip,0.9m	
	U401-B(06BS)	Adult silicone soft tip,0.9m	
	U401-C(06BS)	Pediatric finger clip,0.9m	
	U401-D(06BS)	Pediatric silicone soft tip,0.9m	
	U401-D(06BS-E)	Infant silicone soft tip,0.9m	
	U401-D(06BS-F)	Neonate silicone wrap,0.9m	
	U401-D(06BS-G)	Neonate "Y" type,0.9m	
	U401-A(06BS-H)	Adult ear clip,0.9m	
Datex Ohmeda (10 pin)			
Datex/AS/3, CS/3, CH/S, CH/2S, CH-RS, CG/2S, Cardiocap I, Cardiocap II, Cardiocap 5, Capnomac Ultima, Light Monitor, M-Estrp, Oscar II, OSP-200, Satellite Trans, Satellite Trans Plus, System 5, ULTS50, ULTSIO, ULTSVI, ULTSVOC,	U401-A(06CL)	Adult finger clip,2.8m	
	U401-B(06CL)	Adult silicone soft tip,2.8m	
	U401-C(06CL)	Pediatric finger clip,2.8m	
	U401-D(06CL)	Pediatric silicone soft tip,2.8m	
	U401-D(06CL-E)	Infant silicone soft tip,2.8m	
	U401-D(06CL-F)	Neonate silicone wrap,2.8m	
	U401-D(06CL-G)	Neonate "Y" type,2.8m	
	U401-A(06CL-H)	Adult ear clip,2.8m	
Datex Ohmeda (10 pin)			
(Ohmeda tech)	U401-A(06DL)	Adult finger clip,2.8m	
	U401-B(06DL)	Adult silicone soft tip,2.8m	
	U401-C(06DL)	Pediatric finger clip,2.8m	
	U401-D(06DL)	Pediatric silicone soft tip,2.8m	
	U401-D(06DL-E)	Infant silicone soft tip,2.8m	
	U401-D(06DL-F)	Neonate silicone wrap,2.8m	
	U401-D(06DL-G)	Neonate "Y" type,2.8m	
	U401-A(06DL-H)	Adult ear clip,2.8m	
Datex Ohmeda (7 pin)			
Datex-Ohmeda: 3750, 3710, 5700 Ox/Cap, 5250 RGM, Biox 3760, Ohmeda 3700, 3770, 3775, 3800, Rascal II, GE Medical Systems: 7000 Series, Corometrics 511, TRAM A.R., OXY-W5-H, TRAM Modular xOOSL Series, 200SL, 500SL, 600SL, 800A, 800SL; Mennen: Horizon XL800	U401-A(11AL)	Adult finger clip,2.8m	
	U401-B(11AL)	Adult silicone soft tip,2.8m	
	U401-C(11AL)	Pediatric finger clip,2.8m	
	U401-D(11AL)	Pediatric silicone soft tip,2.8m	
	U401-D(11AL-E)	Infant silicone soft tip,2.8m	
	U401-D(11AL-F)	Neonate silicone wrap,2.8m	
	U401-D(11AL-G)	Neonate "Y" type,2.8m	
	U401-A(11AL-H)	Adult ear clip,2.8m	
Datex Ohmeda (7 pin)			
(Ohmeda Tech)	U401-A(11BL)	Adult finger clip,2.8m	
	U401-B(11BL)	Adult silicone soft tip,2.8m	
	U401-C(11BL)	Pediatric finger clip,2.8m	
	U401-D(11BL)	Pediatric silicone soft tip,2.8m	
	U401-D(11BL-E)	Infant silicone soft tip,2.8m	
	U401-D(11BL-F)	Neonate silicone wrap,2.8m	
	U401-D(11BL-G)	Neonate "Y" type,2.8m	
	U401-A(11BL-H)	Adult ear clip,2.8m	
Datex Ohmeda (9 pin)			
3750, 3710, 5700 Ox/Cap, 5250 RGM, Biox 3760, 3770, 3775, 3800, TuffSat 3775, 3800, 3900, 3900P, 5700 and 5250 respiratory gas monitors Cardiocap/5 with N-XOSAT option, S/5, AS/3, CS/3 Modular Monitors with M-OSAT module, GE: 7000 Series; Corometrics511, TRAM A.R., OXY-W5-H, 200SL, 500SL, 600SL, 800A, 800SL;	U401-A(11CS)	Adult finger clip,0.9m	
	U401-B(11CS)	Adult silicone soft tip,0.9m	
	U401-C(11CS)	Pediatric finger clip,0.9m	
	U401-D(11CS)	Pediatric silicone soft tip,0.9m	
	U401-D(11CS-E)	Infant silicone soft tip,0.9m	
	U401-D(11CS-F)	Neonate silicone wrap,0.9m	
	U401-D(11CS-G)	Neonate "Y" type,0.9m	
	U401-A(11CS-H)	Adult ear clip,0.9m	
Datascope (8 pin)			
Datascope: Accusat, Accutorr 3/5 SAT, Accutorr Plus, Passport (Database Sp02), Passport EL, Passport XG, Datascope MultineX Plus Monitor, Compatible for 0600-00-0026-02	U401-A(14AL)	Adult finger clip,2.8m	
	U401-B(14AL)	Adult silicone soft tip,2.8m	
	U401-C(14AL)	Pediatric finger clip,2.8m	
	U401-D(14AL)	Pediatric silicone soft tip,2.8m	
	U401-D(14AL-E)	Infant silicone soft tip,2.8m	
	U401-D(14AL-F)	Neonate silicone wrap,2.8m	
	U401-D(14AL-G)	Neonate "Y" type,2.8m	
	U401-A(14AL-H)	Adult ear clip,2.8m	

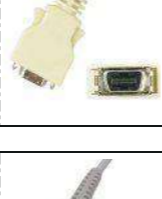
Brand/Compatible Models	P/N	Description	Male Connector
Datascope (9 pin)			
Datascope: Accutorr 3/5 SAT, Accutorr Plus, Passport.	U401-A(14BS)	Adult finger clip,0.9m	
	U401-B(14BS)	Adult silicone soft tip,0.9m	
	U401-C(14BS)	Pediatric finger clip,0.9m	
	U401-D(14BS)	Pediatric silicone soft tip,0.9m	
	U401-D(14BS-E)	Infant silicone soft tip,0.9m	
	U401-D(14BS-F)	Neonate silicone wrap,0.9m	
	U401-D(14BS-G)	Neonate "Y" type,0.9m	
	U401-A(14BS-H)	Adult ear clip,0.9m	
Datascope (14 pin)			
(Masimo tech)	U401-A(14CL)	Adult finger clip,2.8m	
	U401-B(14CL)	Adult silicone soft tip,2.8m	
	U401-C(14CL)	Pediatric finger clip,2.8m	
	U401-D(14CL)	Pediatric silicone soft tip,2.8m	
	U401-D(14CL-E)	Infant silicone soft tip,2.8m	
	U401-D(14CL-F)	Neonate silicone wrap,2.8m	
	U401-D(14CL-G)	Neonate "Y" type,2.8m	
	U401-A(14CL-H)	Adult ear clip,2.8m	
Datascope (6 pin 40°)			
	U401-A(14DL)	Adult finger clip,2.8m	
	U401-B(14DL)	Adult silicone soft tip,2.8m	
	U401-C(14DL)	Pediatric finger clip,2.8m	
	U401-D(14DL)	Pediatric silicone soft tip,2.8m	
	U401-D(14DL-E)	Infant silicone soft tip,2.8m	
	U401-D(14DL-F)	Neonate silicone wrap,2.8m	
	U401-D(14DL-G)	Neonate "Y" type,2.8m	
	U401-A(14DL-H)	Adult ear clip,2.8m	
Digicare (7 pin 40°)			
Digimax 5500	U401-A(81AL)	Adult finger clip,2.8m	
	U401-B(81AL)	Adult silicone soft tip,2.8m	
	U401-C(81AL)	Pediatric finger clip,2.8m	
	U401-D(81AL)	Pediatric silicone soft tip,2.8m	
	U401-D(81AL-E)	Infant silicone soft tip,2.8m	
	U401-D(81AL-F)	Neonate silicone wrap,2.8m	
	U401-D(81AL-G)	Neonate "Y" type,2.8m	
	U401-A(81AL-H)	Adult ear clip,2.8m	
Digicare (9 pin)			
Digimax 5500	U401-A(81BL)	Adult finger clip,2.8m	
	U401-B(81BL)	Adult silicone soft tip,2.8m	
	U401-C(81BL)	Pediatric finger clip,2.8m	
	U401-D(81BL)	Pediatric silicone soft tip,2.8m	
	U401-D(81BL-E)	Infant silicone soft tip,2.8m	
	U401-D(81BL-F)	Neonate silicone wrap,2.8m	
	U401-D(81BL-G)	Neonate "Y" type,2.8m	
	U401-A(81BL-H)	Adult ear clip,2.8m	
Digicare (9 pin)			
	U401-A(81CL)	Adult finger clip,2.8m	
	U401-B(81CL)	Adult silicone soft tip,2.8m	
	U401-C(81CL)	Pediatric finger clip,2.8m	
	U401-D(81CL)	Pediatric silicone soft tip,2.8m	
	U401-D(81CL-E)	Infant silicone soft tip,2.8m	
	U401-D(81CL-F)	Neonate silicone wrap,2.8m	
	U401-D(81CL-G)	Neonate "Y" type,2.8m	
	U401-A(81CL-H)	Adult ear clip,2.8m	
Digicare (14 pin)			
	U401-A(81DL)	Adult finger clip,2.8m	
	U401-B(81DL)	Adult silicone soft tip,2.8m	
	U401-C(81DL)	Pediatric finger clip,2.8m	
	U401-D(81DL)	Pediatric silicone soft tip,2.8m	
	U401-D(81DL-E)	Infant silicone soft tip,2.8m	
	U401-D(81DL-F)	Neonate silicone wrap,2.8m	
	U401-D(81DL-G)	Neonate "Y" type,2.8m	
	U401-A(81DL-H)	Adult ear clip,2.8m	
Dima (7 pin)			
	U401-A(82AL)	Adult finger clip,2.8m	
	U401-B(82AL)	Adult silicone soft tip,2.8m	
	U401-C(82AL)	Pediatric finger clip,2.8m	
	U401-D(82AL)	Pediatric silicone soft tip,2.8m	
	U401-D(82AL-E)	Infant silicone soft tip,2.8m	
	U401-D(82AL-F)	Neonate silicone wrap,2.8m	
	U401-D(82AL-G)	Neonate "Y" type,2.8m	
	U401-A(82AL-H)	Adult ear clip,2.8m	

Brand/Compatible Models	P/N	Description	Male Connector
Dima (7 pin)			
	U401-A(82AS)	Adult finger clip,0.9m	
	U401-B(82AS)	Adult silicone soft tip,0.9m	
	U401-C(82AS)	Pediatric finger clip,0.9m	
	U401-D(82AS)	Pediatric silicone soft tip,0.9m	
	U401-D(82AS-E)	Infant silicone soft tip,0.9m	
	U401-D(82AS-F)	Neonate silicone wrap,0.9m	
	U401-D(82AS-G)	Neonate "Y" type,0.9m	
	U401-A(82AS-H)	Adult ear clip,0.9m	
DST (5 pin)			
DST5000	U401-A(121AL)	Adult finger clip,2.8m	
	U401-B(121AL)	Adult silicone soft tip,2.8m	
	U401-C(121AL)	Pediatric finger clip,2.8m	
	U401-D(121AL)	Pediatric silicone soft tip,2.8m	
	U401-D(121AL-E)	Infant silicone soft tip,2.8m	
	U401-D(121AL-F)	Neonate silicone wrap,2.8m	
	U401-D(121AL-G)	Neonate "Y" type,2.8m	
	U401-A(121AL-H)	Adult ear clip,2.8m	
DST (6 pin 40°)			
DST3000 (Digital tech)	U401-A(121BL)	Adult finger clip,2.8m	
	U401-B(121BL)	Adult silicone soft tip,2.8m	
	U401-C(121BL)	Pediatric finger clip,2.8m	
	U401-D(121BL)	Pediatric silicone soft tip,2.8m	
	U401-D(121BL-E)	Infant silicone soft tip,2.8m	
	U401-D(121BL-F)	Neonate silicone wrap,2.8m	
	U401-D(121BL-G)	Neonate "Y" type,2.8m	
	U401-A(121BL-H)	Adult ear clip,2.8m	
Dixtal (7 pin)			
	U401-A(95AL)	Adult finger clip,2.8m	
	U401-B(95AL)	Adult silicone soft tip,2.8m	
	U401-C(95AL)	Pediatric finger clip,2.8m	
	U401-D(95AL)	Pediatric silicone soft tip,2.8m	
	U401-D(95AL-E)	Infant silicone soft tip,2.8m	
	U401-D(95AL-F)	Neonate silicone wrap,2.8m	
	U401-D(95AL-G)	Neonate "Y" type,2.8m	
	U401-A(95AL-H)	Adult ear clip,2.8m	
Dixtal (6 pin)			
	U401-A(95BS)	Adult finger clip,0.9m	
	U401-B(95BS)	Adult silicone soft tip,0.9m	
	U401-C(95BS)	Pediatric finger clip,0.9m	
	U401-D(95BS)	Pediatric silicone soft tip,0.9m	
	U401-D(95BS-E)	Infant silicone soft tip,0.9m	
	U401-D(95BS-F)	Neonate silicone wrap,0.9m	
	U401-D(95BS-G)	Neonate "Y" type,0.9m	
	U401-A(95BS-H)	Adult ear clip,0.9m	
DRE (5 pin 40°)			
	U401-A(79AL)	Adult finger clip,2.8m	
	U401-B(79AL)	Adult silicone soft tip,2.8m	
	U401-C(79AL)	Pediatric finger clip,2.8m	
	U401-D(79AL)	Pediatric silicone soft tip,2.8m	
	U401-D(79AL-E)	Infant silicone soft tip,2.8m	
	U401-D(79AL-F)	Neonate silicone wrap,2.8m	
	U401-D(79AL-G)	Neonate "Y" type,2.8m	
	U401-A(79AL-H)	Adult ear clip,2.8m	
DRE (6 pin)			
	U401-A(79CL)	Adult finger clip,2.8m	
	U401-B(79CL)	Adult silicone soft tip,2.8m	
	U401-C(79CL)	Pediatric finger clip,2.8m	
	U401-D(79CL)	Pediatric silicone soft tip,2.8m	
	U401-D(79CL-E)	Infant silicone soft tip,2.8m	
	U401-D(79CL-F)	Neonate silicone wrap,2.8m	
	U401-D(79CL-G)	Neonate "Y" type,2.8m	
	U401-A(79CL-H)	Adult ear clip,2.8m	
DRE (7 pin)			
	U401-A(79BL)	Adult finger clip,2.8m	
	U401-B(79BL)	Adult silicone soft tip,2.8m	
	U401-C(79BL)	Pediatric finger clip,2.8m	
	U401-D(79BL)	Pediatric silicone soft tip,2.8m	
	U401-D(79BL-E)	Infant silicone soft tip,2.8m	
	U401-D(79BL-F)	Neonate silicone wrap,2.8m	
	U401-D(79BL-G)	Neonate "Y" type,2.8m	
	U401-A(79BL-H)	Adult ear clip,2.8m	
Ecomed (6 pin)			
(Digital tech)	U401-A(156AL)	Adult finger clip,2.8m	
	U401-B(156AL)	Adult silicone soft tip,2.8m	
	U401-C(156AL)	Pediatric finger clip,2.8m	
	U401-D(156AL)	Pediatric silicone soft tip,2.8m	
	U401-D(156AL-E)	Infant silicone soft tip,2.8m	
	U401-D(156AL-F)	Neonate silicone wrap,2.8m	
	U401-D(156AL-G)	Neonate "Y" type,2.8m	
	U401-A(156AL-H)	Adult ear clip,2.8m	

Brand/Compatible Models	P/N	Description	Male Connector
Ecocomd (6 pin 40°)			
EPM-50	U401-A(156BL)	Adult finger clip,2.8m	
	U401-B(156BL)	Adult silicone soft tip,2.8m	
	U401-C(156BL)	Pediatric finger clip,2.8m	
	U401-D(156BL)	Pediatric silicone soft tip,2.8m	
	U401-D(156BL-E)	Infant silicone soft tip,2.8m	
	U401-D(156BL-F)	Neonate silicone wrap,2.8m	
	U401-D(156BL-G)	Neonate "Y" type,2.8m	
	U401-A(156BL-H)	Adult ear clip,2.8m	
Edan (5 pin)			
(Digital tech)	U401-A(72AL)	Adult finger clip,2.8m	
	U401-B(72AL)	Adult silicone soft tip,2.8m	
	U401-C(72AL)	Pediatric finger clip,2.8m	
	U401-D(72AL)	Pediatric silicone soft tip,2.8m	
	U401-D(72AL-E)	Infant silicone soft tip,2.8m	
	U401-D(72AL-F)	Neonate silicone wrap,2.8m	
	U401-D(72AL-G)	Neonate "Y" type,2.8m	
	U401-A(72AL-H)	Adult ear clip,2.8m	
Edan (6 pin 40°)			
M9	U401-A(72BL)	Adult finger clip,2.8m	
	U401-B(72BL)	Adult silicone soft tip,2.8m	
	U401-C(72BL)	Pediatric finger clip,2.8m	
	U401-D(72BL)	Pediatric silicone soft tip,2.8m	
	U401-D(72BL-E)	Infant silicone soft tip,2.8m	
	U401-D(72BL-F)	Neonate silicone wrap,2.8m	
	U401-D(72BL-G)	Neonate "Y" type,2.8m	
	U401-A(72BL-H)	Adult ear clip,2.8m	
Edan (7 pin)			
H100B (Non-Oximax)	U401-A(72CL)	Adult finger clip,2.8m	
	U401-B(72CL)	Adult silicone soft tip,2.8m	
	U401-C(72CL)	Pediatric finger clip,2.8m	
	U401-D(72CL)	Pediatric silicone soft tip,2.8m	
	U401-D(72CL-E)	Infant silicone soft tip,2.8m	

F~G

Brand/Compatible Models	P/N	Description	Male Connector
Fukuda Denshi (9 pin)			
DS7100_DS7300 (Oximax tech)	U401-A(69AS)	Adult finger clip,0.9m	
	U401-B(69AS)	Adult silicone soft tip,0.9m	
	U401-C(69AS)	Pediatric finger clip,0.9m	
	U401-D(69AS)	Pediatric silicone soft tip,0.9m	
	U401-E(69AS-E)	Infant silicone soft tip,0.9m	
	U401-D(69AS-F)	Neonate silicone wrap,0.9m	
	U401-D(69AS-G)	Neonate "Y" type,0.9m	
	U401-A(69AS-H)	Adult ear clip,0.9m	
Fukuda Denshi (14 pin)			
DS7100-DS7300	U401-A(69BL)	Adult finger clip,2.8m	
	U401-B(69BL)	Adult silicone soft tip,2.8m	
	U401-C(69BL)	Pediatric finger clip,2.8m	
	U401-D(69BL)	Pediatric silicone soft tip,2.8m	
	U401-E(69BL-E)	Infant silicone soft tip,2.8m	
	U401-D(69BL-F)	Neonate silicone wrap,2.8m	
	U401-D(69BL-G)	Neonate "Y" type,2.8m	
	U401-A(69BL-H)	Adult ear clip,2.8m	
Goldway (5 pin)			
UT5000A	U401-A(08BL)	Adult finger clip,2.8m	
	U401-B(08BL)	Adult silicone soft tip,2.8m	
	U401-C(08BL)	Pediatric finger clip,2.8m	
	U401-D(08BL)	Pediatric silicone soft tip,2.8m	
	U401-E(08BL-E)	Infant silicone soft tip,2.8m	
	U401-D(08BL-F)	Neonate silicone wrap,2.8m	
	U401-D(08BL-G)	Neonate "Y" type,2.8m	
	U401-A(08BL-H)	Adult ear clip,2.8m	
Goldway (7 pin 40°)			
5000F	U401-A(08CL)	Adult finger clip,2.8m	
	U401-B(08CL)	Adult silicone soft tip,2.8m	
	U401-C(08CL)	Pediatric finger clip,2.8m	
	U401-D(08CL)	Pediatric silicone soft tip,2.8m	
	U401-E(08CL-E)	Infant silicone soft tip,2.8m	
	U401-D(08CL-F)	Neonate silicone wrap,2.8m	
	U401-D(08CL-G)	Neonate "Y" type,2.8m	
	U401-A(08CL-H)	Adult ear clip,2.8m	
Goldway (7 pin)			
(Oximax tech)	U401-A(08DL)	Adult finger clip,2.8m	
	U401-B(08DL)	Adult silicone soft tip,2.8m	
	U401-C(08DL)	Pediatric finger clip,2.8m	
	U401-D(08DL)	Pediatric silicone soft tip,2.8m	
	U401-E(08DL-E)	Infant silicone soft tip,2.8m	
	U401-D(08DL-F)	Neonate silicone wrap,2.8m	
	U401-D(08DL-G)	Neonate "Y" type,2.8m	
	U401-A(08DL-H)	Adult ear clip,2.8m	
GE Trusat (9 pin)			
GE Ohmeda TruSat, TruSat ED, TruSat TD.	U401-A(02AL)	Adult finger clip,2.8m	
	U401-B(02AL)	Adult silicone soft tip,2.8m	
	U401-C(02AL)	Pediatric finger clip,2.8m	
	U401-D(02AL)	Pediatric silicone soft tip,2.8m	
	U401-E(02AL-E)	Infant silicone soft tip,2.8m	
	U401-D(02AL-F)	Neonate silicone wrap,2.8m	
	U401-D(02AL-G)	Neonate "Y" type,2.8m	
	U401-A(02AL-H)	Adult ear clip,2.8m	
GE Trusignal (9 pin)			
GE Trusignal	U401-A(02BL)	Adult finger clip,2.8m	
	U401-B(02BL)	Adult silicone soft tip,2.8m	
	U401-C(02BL)	Pediatric finger clip,2.8m	
	U401-D(02BL)	Pediatric silicone soft tip,2.8m	
	U401-E(02BL-E)	Infant silicone soft tip,2.8m	
	U401-D(02BL-F)	Neonate silicone wrap,2.8m	
	U401-D(02BL-G)	Neonate "Y" type,2.8m	
	U401-A(02BL-H)	Adult ear clip,2.8m	
GE Trusignal	U401-A(02BS)	Adult finger clip,0.9m	
	U401-B(02BS)	Adult silicone soft tip,0.9m	
	U401-C(02BS)	Pediatric finger clip,0.9m	
	U401-D(02BS)	Pediatric silicone soft tip,0.9m	
	U401-E(02BS-E)	Infant silicone soft tip,0.9m	
	U401-D(02BS-F)	Neonate silicone wrap,0.9m	
	U401-D(02BS-G)	Neonate "Y" type,0.9m	
	U401-A(02BS-H)	Adult ear clip,0.9m	
GE (9 pin)			
(Oximax tech)	U401-A(02CL)	Adult finger clip,2.8m	
	U401-B(02CL)	Adult silicone soft tip,2.8m	
	U401-C(02CL)	Pediatric finger clip,2.8m	
	U401-D(02CL)	Pediatric silicone soft tip,2.8m	
	U401-E(02CL-E)	Infant silicone soft tip,2.8m	
	U401-D(02CL-F)	Neonate silicone wrap,2.8m	
	U401-D(02CL-G)	Neonate "Y" type,2.8m	
	U401-A(02CL-H)	Adult ear clip,2.8m	

Brand/Compatible Models	P/N	Description	Male Connector
GE (9 pin)			
(Oximax tech)	U401-A(02CS)	Adult finger clip,0.9m	
	U401-B(02CS)	Adult silicone soft tip,0.9m	
	U401-C(02CS)	Pediatric finger clip,0.9m	
	U401-D(02CS)	Pediatric silicone soft tip,0.9m	
	U401-E(02CS-E)	Infant silicone soft tip,0.9m	
	U401-D(02CS-F)	Neonate silicone wrap,0.9m	
	U401-D(02CS-G)	Neonate "Y" type,0.9m	
	U401-A(02CS-H)	Adult ear clip,0.9m	
GE (11 pin)			
GE Medical Systems: Eagle Dash, Solar series TRAM Modular50XL Series (Nellcor tech)	U401-A(02DL)	Adult finger clip,2.8m	
	U401-B(02DL)	Adult silicone soft tip,2.8m	
	U401-C(02DL)	Pediatric finger clip,2.8m	
	U401-D(02DL)	Pediatric silicone soft tip,2.8m	
	U401-E(02DL-E)	Infant silicone soft tip,2.8m	
	U401-D(02DL-F)	Neonate silicone wrap,2.8m	
	U401-D(02DL-G)	Neonate "Y" type,2.8m	
	U401-A(02DL-H)	Adult ear clip,2.8m	
GE (11 pin)			
Dash 2000,2500,3000, 5000, Solar 7000,8000; Eagle: 1000,3000,SMK,SMV (Masimo tech)	U401-A(02EL)	Adult finger clip,2.8m	
	U401-B(02EL)	Adult silicone soft tip,2.8m	
	U401-C(02EL)	Pediatric finger clip,2.8m	
	U401-D(02EL)	Pediatric silicone soft tip,2.8m	
	U401-E(02EL-E)	Infant silicone soft tip,2.8m	
	U401-D(02EL-F)	Neonate silicone wrap,2.8m	
	U401-D(02EL-G)	Neonate "Y" type,2.8m	
	U401-A(02EL-H)	Adult ear clip,2.8m	
GE (11 pin)			
Sensor Solutions for datex ohmeda S/5 FM Ports (Ohmeda tech)	U401-A(02FL)	Adult finger clip,2.8m	
	U401-B(02FL)	Adult silicone soft tip,2.8m	
	U401-C(02FL)	Pediatric finger clip,2.8m	
	U401-D(02FL)	Pediatric silicone soft tip,2.8m	
	U401-E(02FL-E)	Infant silicone soft tip,2.8m	
	U401-D(02FL-F)	Neonate silicone wrap,2.8m	
	U401-D(02FL-G)	Neonate "Y" type,2.8m	
	U401-A(02FL-H)	Adult ear clip,2.8m	
GE (11 pin)			
GE Dash 2500/5800 (Oximax tech)	U401-A(02GL)	Adult finger clip,2.8m	
	U401-B(02GL)	Adult silicone soft tip,2.8m	
	U401-C(02GL)	Pediatric finger clip,2.8m	
	U401-D(02GL)	Pediatric silicone soft tip,2.8m	
	U401-E(02GL-E)	Infant silicone soft tip,2.8m	
	U401-D(02GL-F)	Neonate silicone wrap,2.8m	
	U401-D(02GL-G)	Neonate "Y" type,2.8m	
	U401-A(02GL-H)	Adult ear clip,2.8m	
GE (11 pin)			
B20, B40, B650 (Original Oximax chips)	U401-A(02LL)	Adult finger clip,2.8m	
	U401-B(02LL)	Adult silicone soft tip,2.8m	
	U401-C(02LL)	Pediatric finger clip,2.8m	
	U401-D(02LL)	Pediatric silicone soft tip,2.8m	
	U401-E(02LL-E)	Infant silicone soft tip,2.8m	
	U401-D(02LL-F)	Neonate silicone wrap,2.8m	
	U401-D(02LL-G)	Neonate "Y" type,2.8m	
	U401-A(02LL-H)	Adult ear clip,2.8m	
GE (11 pin)			
B30 (Oximax tech)	U401-A(02ML)	Adult finger clip,2.8m	
	U401-B(02ML)	Adult silicone soft tip,2.8m	
	U401-C(02ML)	Pediatric finger clip,2.8m	
	U401-D(02ML)	Pediatric silicone soft tip,2.8m	
	U401-E(02ML-E)	Infant silicone soft tip,2.8m	
	U401-D(02ML-F)	Neonate silicone wrap,2.8m	
	U401-D(02ML-G)	Neonate "Y" type,2.8m	
	U401-A(02ML-H)	Adult ear clip,2.8m	
GE (11 pin)			
B20, B40, B650 (Masimo + Oximax tech)	U401-A(02NL)	Adult finger clip,2.8m	
	U401-B(02NL)	Adult silicone soft tip,2.8m	
	U401-C(02NL)	Pediatric finger clip,2.8m	
	U401-D(02NL)	Pediatric silicone soft tip,2.8m	
	U401-E(02NL-E)	Infant silicone soft tip,2.8m	
	U401-D(02NL-F)	Neonate silicone wrap,2.8m	
	U401-D(02NL-G)	Neonate "Y" type,2.8m	
	U401-A(02NL-H)	Adult ear clip,2.8m	
GE (11 pin)			
B20, B40, B650 (Ohmeda + Oximax tech)	U401-A(02PL)	Adult finger clip,2.8m	
	U401-B(02PL)	Adult silicone soft tip,2.8m	
	U401-C(02PL)	Pediatric finger clip,2.8m	
	U401-D(02PL)	Pediatric silicone soft tip,2.8m	
	U401-E(02PL-E)	Infant silicone soft tip,2.8m	
	U401-D(02PL-F)	Neonate silicone wrap,2.8m	
	U401-D(02PL-G)	Neonate "Y" type,2.8m	
	U401-A(02PL-H)	Adult ear clip,2.8m	

Brand/Compatible Models	P/N	Description	Male Connector
Generra / Pace Tech (5 pin)			
Generra: 710, 200, 300, 500, 810, 530 Pace Techs Model 520, with black face (except for Vitalmax 800w Nellcor).	U401-A(30AL)	Adult finger clip,2.8m	
	U401-B(30AL)	Adult silicone soft tip,2.8m	
	U401-C(30AL)	Pediatric finger clip,2.8m	
	U401-D(30AL)	Pediatric silicone soft tip,2.8m	
	U401-E(30AL-E)	Infant silicone soft tip,2.8m	
	U401-D(30AL-F)	Neonate silicone wrap,2.8m	
	U401-D(30AL-G)	Neonate "Y" type,2.8m	
	U401-A(30AL-H)	Adult ear clip,2.8m	
Generra / Pace Tech (7 pin)			
U401-A(30BL)	U401-A(30BL)	Adult finger clip,2.8m	
	U401-B(30BL)	Adult silicone soft tip,2.8m	
	U401-C(30BL)	Pediatric finger clip,2.8m	
	U401-D(30BL)	Pediatric silicone soft tip,2.8m	
	U401-E(30BL-E)	Infant silicone soft tip,2.8m	
	U401-D(30BL-F)	Neonate silicone wrap,2.8m	
	U401-D(30BL-G)	Neonate "Y" type,2.8m	
	U401-A(30BL-H)	Adult ear clip,2.8m	
Guoteng (6 pin)			
G13000,5000,6000,9000	U401-A(76AL)	Adult finger clip,2.8m	
	U401-B(76AL)	Adult silicone soft tip,2.8m	
	U401-C(76AL)	Pediatric finger clip,2.8m	
	U401-D(76AL)	Pediatric silicone soft tip,2.8m	
	U401-E(76AL-E)	Infant silicone soft tip,2.8m	
	U401-D(76AL-F)	Neonate silicone wrap,2.8m	
	U401-D(76AL-G)	Neonate "Y" type,2.8m	
	U401-A(76AL-H)	Adult ear clip,2.8m	
Heal Force (5 pin 80°)			
U401-A(78AL)	U401-A(78AL)	Adult finger clip,2.8m	
	U401-B(78AL)	Adult silicone soft tip,2.8m	
	U401-C(78AL)	Pediatric finger clip,2.8m	
	U401-D(78AL)	Pediatric silicone soft tip,2.8m	
	U401-E(78AL-E)	Infant silicone soft tip,2.8m	
	U401-D(78AL-F)	Neonate silicone wrap,2.8m	
	U401-D(78AL-G)	Neonate "Y" type,2.8m	
	U401-A(78AL-H)	Adult ear clip,2.8m	
Hellige (10 pin)			
Servomed5 Generation SCP 855,851,852-SCS 805,SMK 151,153,155,156,157,159,160,161,162,163,164,165,166,167,168,169,170,171,172,173,174,175,176,177,178,179,180,181,182,SMV 105T,107,110,111,168, SMS316,SMC108,SMV105,Servomed N5, Servocord,Serie Cardiosev, Vicom SM, SMU 511,611,612,630, Serie SMK-200,SMK210,211,230, 231, 250, 250, SMP 300,310, Pepita 201,202R, 203,Pepita 203, R205,205R,205,Pepita 205R.	U401-A(27AL)	Adult finger clip,2.8m	
	U401-B(27AL)	Adult silicone soft tip,2.8m	
	U401-C(27AL)	Pediatric finger clip,2.8m	
	U401-D(27AL)	Pediatric silicone soft tip,2.8m	
	U401-E(27AL-E)	Infant silicone soft tip,2.8m	
	U401-D(27AL-F)	Neonate silicone wrap,2.8m	
	U401-D(27AL-G)	Neonate "Y" type,2.8m	
	U401-A(27AL-H)	Adult ear clip,2.8m	
Huntleigh (7 pin)			
U401-A(77AL)	U401-A(77AL)	Adult finger clip,2.8m	
	U401-B(77AL)	Adult silicone soft tip,2.8m	
	U401-C(77AL)	Pediatric finger clip,2.8m	
	U401-D(77AL)	Pediatric silicone soft tip,2.8m	
	U401-E(77AL-E)	Infant silicone soft tip,2.8m	
	U401-D(77AL-F)	Neonate silicone wrap,2.8m	
	U401-D(77AL-G)	Neonate "Y" type,2.8m	
	U401-A(77AL-H)	Adult ear clip,2.8m	
Heyer (6 pin)			
Scalis	U401-A(112BL)	Adult finger clip,2.8m	
	U401-B(112BL)	Adult silicone soft tip,2.8m	
	U401-C(112BL)	Pediatric finger clip,2.8m	
	U401-D(112BL)	Pediatric silicone soft tip,2.8m	
	U401-E(112BL-E)	Infant silicone soft tip,2.8m	
	U401-D(112BL-F)	Neonate silicone wrap,2.8m	
	U401-D(112BL-G)	Neonate "Y" type,2.8m	
	U401-A(112BL-H)	Adult ear clip,2.8m	
Infinium (5 pin)			
(Digital Tech)	U401-A(67AL)	Adult finger clip,2.8m	
	U401-B(67AL)	Adult silicone soft tip,2.8m	
	U401-C(67AL)	Pediatric finger clip,2.8m	
	U401-D(67AL)	Pediatric silicone soft tip,2.8m	
	U401-E(67AL-E)	Infant silicone soft tip,2.8m	
	U401-D(67AL-F)	Neonate silicone wrap,2.8m	
	U401-D(67AL-G)	Neonate "Y" type,2.8m	
	U401-A(67AL-H)	Adult ear clip,2.8m	
Infinium (5 pin 40°)			
(Digital Tech)	U401-A(67BL)	Adult finger clip,2.8m	
	U401-B(67BL)	Adult silicone soft tip,2.8m	
	U401-C(67BL)	Pediatric finger clip,2.8m	
	U401-D(67BL)	Pediatric silicone soft tip,2.8m	
	U401-E(67BL-E)	Infant silicone soft tip,2.8m	
	U401-D(67BL-F)	Neonate silicone wrap,2.8m	
	U401-D(67BL-G)	Neonate "Y" type,2.8m	
	U401-A(67BL-H)	Adult ear clip,2.8m	

Brand/Compatible Models	P/N	Description	Male Connector
Infinium (6 pin)			
OMNI III	U401-A(67CL)	Adult finger clip,2.8m	
	U401-B(67CL)	Adult silicone soft tip,2.8m	
	U401-C(67CL)	Pediatric finger clip,2.8m	
	U401-D(67CL)	Pediatric silicone soft tip,2.8m	
	U401-E(67CL-E)	Infant silicone soft tip,2.8m	
	U401-D(67CL-F)	Neonate silicone wrap,2.8m	
	U401-D(67CL-G)	Neonate "Y" type,2.8m	
	U401-A(67CL-H)	Adult ear clip,2.8m	
Infinium (10 pin)			
U401-A(67DL)	U401-A(67DL)	Adult finger clip,2.8m	
	U401-B(67DL)	Adult silicone soft tip,2.8m	
	U401-C(67DL)	Pediatric finger clip,2.8m	
	U401-D(67DL)	Pediatric silicone soft tip,2.8m	
	U401-E(67DL-E)	Infant silicone soft tip,2.8m	
	U401-D(67DL-F)	Neonate silicone wrap,2.8m	
	U401-D(67DL-G)	Neonate "Y" type,2.8m	
	U401-A(67DL-H)	Adult ear clip,2.8m	
Infinium (12 pin)			
U401-A(67EL)	U401-A(67EL)	Adult finger clip,2.8m	
	U401-B(67EL)	Adult silicone soft tip,2.8m	
	U401-C(67EL)	Pediatric finger clip,2.8m	
	U401-D(67EL)	Pediatric silicone soft tip,2.8m	
	U401-E(67EL-E)	Infant silicone soft tip,2.8m	
	U401-D(67EL-F)	Neonate silicone wrap,2.8m	
	U401-D(67EL-G)	Neonate "Y" type,2.8m	
	U401-A(67EL-H)	Adult ear clip,2.8m	
Invivo (7 pin)			
5500,5500puls,Millenia,OMEGA1555,Omni-Trakivs,Satscout,(Nellcor tech)	U401-A(28AL)	Adult finger clip,2.8m	
	U401-B(28AL)	Adult silicone soft tip,2.8m	
	U401-C(28AL)	Pediatric finger clip,2.8m	
	U401-D(28AL)	Pediatric silicone soft tip,2.8m	
	U401-E(28AL-E)	Infant silicone soft tip,2.8m	
	U401-D(28AL-F)	Neonate silicone wrap,2.8m	
	U401-D(28AL-G)	Neonate "Y" type,2.8m	
	U401-A(28AL-H)	Adult ear clip,2.8m	
Invivo (7 pin)			
M8 (Masimo tech)	U401-A(28BL)	Adult finger clip,2.8m	
	U40		

Brand/Compatible Models	P/N	Description	Male Connector
Kontron (12 pin)			
Kontron: 7138, 7850, 7855, Minimon 7137 Y 7337, Micromon, Supermon, Kolormon, Trakmon.	U401-A(29AL)	Adult finger clip,2.8m	
	U401-B(29AL)	Adult silicone soft tip,2.8m	
	U401-C(29AL)	Pediatric finger clip,2.8m	
	U401-D(29AL)	Pediatric silicone soft tip,2.8m	
	U401-D(29AL-E)	Infant silicone soft tip,2.8m	
	U401-D(29AL-F)	Neonate silicone wrap,2.8m	
	U401-D(29AL-G)	Neonate "Y" type,2.8m	
	U401-A(29AL-H)	Adult ear clip,2.8m	
Lefu (6 pin 40°)			
	U401-A(93AL)	Adult finger clip,2.8m	
	U401-B(93AL)	Adult silicone soft tip,2.8m	
	U401-C(93AL)	Pediatric finger clip,2.8m	
	U401-D(93AL)	Pediatric silicone soft tip,2.8m	
	U401-D(93AL-E)	Infant silicone soft tip,2.8m	
	U401-D(93AL-F)	Neonate silicone wrap,2.8m	
	U401-D(93AL-G)	Neonate "Y" type,2.8m	
	U401-A(93AL-H)	Adult ear clip,2.8m	
Lefu (6 pin 60°)			
(Digital tech)	U401-A(93BL)	Adult finger clip,2.8m	
	U401-B(93BL)	Adult silicone soft tip,2.8m	
	U401-C(93BL)	Pediatric finger clip,2.8m	
	U401-D(93BL)	Pediatric silicone soft tip,2.8m	
	U401-D(93BL-E)	Infant silicone soft tip,2.8m	
	U401-D(93BL-F)	Neonate silicone wrap,2.8m	
	U401-D(93BL-G)	Neonate "Y" type,2.8m	
	U401-A(93BL-H)	Adult ear clip,2.8m	
Lutech (6 pin)			
Datatals 700	U401-A(165AL)	Adult finger clip,2.8m	
	U401-B(165AL)	Adult silicone soft tip,2.8m	
	U401-C(165AL)	Pediatric finger clip,2.8m	
	U401-D(165AL)	Pediatric silicone soft tip,2.8m	
	U401-D(165AL-E)	Infant silicone soft tip,2.8m	
	U401-D(165AL-F)	Neonate silicone wrap,2.8m	
	U401-D(165AL-G)	Neonate "Y" type,2.8m	
	U401-A(165AL-H)	Adult ear clip,2.8m	
Lohmeier			
Lohmeier M010	U401-A(18AL)	Adult finger clip,2.8m	
	U401-B(18AL)	Adult silicone soft tip,2.8m	
	U401-C(18AL)	Pediatric finger clip,2.8m	
	U401-D(18AL)	Pediatric silicone soft tip,2.8m	
	U401-D(18AL-E)	Infant silicone soft tip,2.8m	
	U401-D(18AL-F)	Neonate silicone wrap,2.8m	
	U401-D(18AL-G)	Neonate "Y" type,2.8m	
	U401-A(18AL-H)	Adult ear clip,2.8m	
Mindray (5 pin)			
Mindray PM9000 with Criticare technology,Goldway UT5000.	U401-A(03DL)	Adult finger clip,2.8m	
	U401-B(03DL)	Adult silicone soft tip,2.8m	
	U401-C(03DL)	Pediatric finger clip,2.8m	
	U401-D(03DL)	Pediatric silicone soft tip,2.8m	
	U401-D(03DL-E)	Infant silicone soft tip,2.8m	
	U401-D(03DL-F)	Neonate silicone wrap,2.8m	
	U401-D(03DL-G)	Neonate "Y" type,2.8m	
	U401-A(03DL-H)	Adult ear clip,2.8m	
Mindray (6 pin 40°)			
Mindray:PM7000,6201,8000,9000, VS800(mindray module),MEC-1000, MEC-1200,MEC-2000... Medec-M-1000, M-1100 Kontron:7138,7850,7855, Biocare: BM9000,Jumper,Creative:PC9000, UP6000 Edan: M3, M3A, M3B, M8, M8A, M8B, M9, M9A, M50, M80, IM8, M8A, M8B, IM9, M9A, M50, M80 with nellcor module (Nellcor tech)	U401-A(03EL)	Adult finger clip,2.8m	
	U401-B(03EL)	Adult silicone soft tip,2.8m	
	U401-C(03EL)	Pediatric finger clip,2.8m	
	U401-D(03EL)	Pediatric silicone soft tip,2.8m	
	U401-D(03EL-E)	Infant silicone soft tip,2.8m	
	U401-D(03EL-F)	Neonate silicone wrap,2.8m	
	U401-D(03EL-G)	Neonate "Y" type,2.8m	
	U401-A(03EL-H)	Adult ear clip,2.8m	
Mindray (6 pin 60°)			
Mindray:PM7000,6201,8000,9000, VS800(mindray module),MEC-1000, MEC-1200,MEC-2000... Medec-M-1000, M-1100 Kontron:7138,7850,7855, Biocare: BM9000,Jumper,Creative:PC9000, UP6000 Edan: M3, M3A, M3B, M8, M8A, M8B, M9, M9A, M50, M80, IM8, M8A, M8B, IM9, M9A, M50, M80 with nellcor module (Nellcor tech)	U401-A(03FL)	Adult finger clip,2.8m	
	U401-B(03FL)	Adult silicone soft tip,2.8m	
	U401-C(03FL)	Pediatric finger clip,2.8m	
	U401-D(03FL)	Pediatric silicone soft tip,2.8m	
	U401-D(03FL-E)	Infant silicone soft tip,2.8m	
	U401-D(03FL-F)	Neonate silicone wrap,2.8m	
	U401-D(03FL-G)	Neonate "Y" type,2.8m	
	U401-A(03FL-H)	Adult ear clip,2.8m	
Mindray (6 pin 80°)			
Mindray:PM7000,6201,8000,9000, VS800(mindray module),MEC-1000, MEC-1200,MEC-2000... Medec-M-1000, M-1100 Kontron:7138,7850,7855, Biocare: BM9000,Jumper,Creative:PC9000, UP6000 Edan: M3, M3A, M3B, M8, M8A, M8B, M9, M9A, M50, M80, IM8, M8A, M8B, IM9, M9A, M50, M80 with nellcor module (Nellcor tech)	U401-A(03GL)	Adult finger clip,2.8m	
	U401-B(03GL)	Adult silicone soft tip,2.8m	
	U401-C(03GL)	Pediatric finger clip,2.8m	
	U401-D(03GL)	Pediatric silicone soft tip,2.8m	
	U401-D(03GL-E)	Infant silicone soft tip,2.8m	
	U401-D(03GL-F)	Neonate silicone wrap,2.8m	
	U401-D(03GL-G)	Neonate "Y" type,2.8m	
	U401-A(03GL-H)	Adult ear clip,2.8m	

Brand/Compatible Models	P/N	Description	Male Connector
Mindray (6 pin 40°)			
PM9000,PM9100,PM9200,PM6201,PM7000,PM8000(before 2006) (Masimo tech)	U401-A(03HL)	Adult finger clip,2.8m	
	U401-B(03HL)	Adult silicone soft tip,2.8m	
	U401-C(03HL)	Pediatric finger clip,2.8m	
	U401-D(03HL)	Pediatric silicone soft tip,2.8m	
	U401-D(03HL-E)	Infant silicone soft tip,2.8m	
	U401-D(03HL-F)	Neonate silicone wrap,2.8m	
	U401-D(03HL-G)	Neonate "Y" type,2.8m	
	U401-A(03HL-H)	Adult ear clip,2.8m	
Mindray (6 pin 60°)			
PM9000 Express,PM9201,PM8002,PM6201,PM7000,PM8000(since 2006) (Masimo tech)	U401-A(03JL)	Adult finger clip,2.8m	
	U401-B(03JL)	Adult silicone soft tip,2.8m	
	U401-C(03JL)	Pediatric finger clip,2.8m	
	U401-D(03JL)	Pediatric silicone soft tip,2.8m	
	U401-D(03JL-E)	Infant silicone soft tip,2.8m	
	U401-D(03JL-F)	Neonate silicone wrap,2.8m	
	U401-D(03JL-G)	Neonate "Y" type,2.8m	
	U401-A(03JL-H)	Adult ear clip,2.8m	
Mindray (6 pin 80°)			
VS800 (Masimo tech)	U401-A(03KL)	Adult finger clip,2.8m	
	U401-B(03KL)	Adult silicone soft tip,2.8m	
	U401-C(03KL)	Pediatric finger clip,2.8m	
	U401-D(03KL)	Pediatric silicone soft tip,2.8m	
	U401-D(03KL-E)	Infant silicone soft tip,2.8m	
	U401-D(03KL-F)	Neonate silicone wrap,2.8m	
	U401-D(03KL-G)	Neonate "Y" type,2.8m	
	U401-A(03KL-H)	Adult ear clip,2.8m	
Mindray (6 pin 40°)			
(Oximax tech)	U401-A(03LL)	Adult finger clip,2.8m	
	U401-B(03LL)	Adult silicone soft tip,2.8m	
	U401-C(03LL)	Pediatric finger clip,2.8m	
	U401-D(03LL)	Pediatric silicone soft tip,2.8m	
	U401-D(03LL-E)	Infant silicone soft tip,2.8m	
	U401-D(03LL-F)	Neonate silicone wrap,2.8m	
	U401-D(03LL-G)	Neonate "Y" type,2.8m	
	U401-A(03LL-H)	Adult ear clip,2.8m	
Mindray (6 pin 60°)			
PM-7000,6201,8000,9000 (Oximax tech)	U401-A(03ML)	Adult finger clip,2.8m	
	U401-B(03ML)	Adult silicone soft tip,2.8m	
	U401-C(03ML)	Pediatric finger clip,2.8m	
	U401-D(03ML)	Pediatric silicone soft tip,2.8m	
	U401-D(03ML-E)	Infant silicone soft tip,2.8m	
	U401-D(03ML-F)	Neonate silicone wrap,2.8m	
	U401-D(03ML-G)	Neonate "Y" type,2.8m	
	U401-A(03ML-H)	Adult ear clip,2.8m	
Mindray (6 pin 80°)			
(Oximax tech)	U401-A(03NL)	Adult finger clip,2.8m	
	U401-B(03NL)	Adult silicone soft tip,2.8m	
	U401-C(03NL)	Pediatric finger clip,2.8m	
	U401-D(03NL)	Pediatric silicone soft tip,2.8m	
	U401-D(03NL-E)	Infant silicone soft tip,2.8m	
	U401-D(03NL-F)	Neonate silicone wrap,2.8m	
	U401-D(03NL-G)	Neonate "Y" type,2.8m	
	U401-A(03NL-H)	Adult ear clip,2.8m	
Mindray (7 pin)			
BeneView T8, T5, T1,uMEC, iPM-9800, iPM 12, iPM 10, iPM 8, iMEC 12, iMEC10, iMEC 8, BeneHeart D6, BeneHeart D3,VS-600, VS-900, uMEC (Nellcor tech)	U401-A(03PL)	Adult finger clip,2.8m	
	U401-B(03PL)	Adult silicone soft tip,2.8m	
	U401-C(03PL)	Pediatric finger clip,2.8m	
	U401-D(03PL)	Pediatric silicone soft tip,2.8m	
	U401-D(03PL-E)	Infant silicone soft tip,2.8m	
	U401-D(03PL-F)	Neonate silicone wrap,2.8m	
	U401-D(03PL-G)	Neonate "Y" type,2.8m	
	U401-A(03PL-H)	Adult ear clip,2.8m	
Mindray (7 pin)			
BeneView T8, T5, T1,uMEC, iPM-9800, iPM 12, iPM 10, iPM 8, iMEC 12, iMEC10, iMEC 8, BeneHeart D6, BeneHeart D3,VS-600, VS-900, uMEC (Masimo tech)	U401-A(03QL)	Adult finger clip,2.8m	
	U401-B(03QL)	Adult silicone soft tip,2.8m	
	U401-C(03QL)	Pediatric finger clip,2.8m	
	U401-D(03QL)	Pediatric silicone soft tip,2.8m	
	U401-D(03QL-E)	Infant silicone soft tip,2.8m	
	U401-D(03QL-F)	Neonate silicone wrap,2.8m	
	U401-D(03QL-G)	Neonate "Y" type,2.8m	
	U401-A(03QL-H)	Adult ear clip,2.8m	
Mindray (8 pin)			
BeneView T8, T5, T1,uMEC, iPM-9800, iPM 12, iPM 10, iPM 8, iMEC 12, iMEC10, iMEC 8, BeneHeart D6, BeneHeart D3,VS-600, VS-900, uMEC (Oximax tech)	U401-A(03SL)	Adult finger clip,2.8m	
	U401-B(03SL)	Adult silicone soft tip,2.8m	
	U401-C(03SL)	Pediatric finger clip,2.8m	
	U401-D(03SL)	Pediatric silicone soft tip,2.8m	
	U401-D(03SL-E)	Infant silicone soft tip,2.8m	
	U401-D(03SL-F)	Neonate silicone wrap,2.8m	
	U401-D(03SL-G)	Neonate "Y" type,2.8m	
	U401-A(03SL-H)	Adult ear clip,2.8m	

Brand/Compatible Models	P/N	Description	Male Connector
Mindray (8 pin)			
BeneView T8, T5, T1,uMEC, iPM-9800, iPM 12, iPM 10, iPM 8, iMEC 12, iMEC10, iMEC 8, BeneHeart D6, BeneHeart D3,VS-600, VS-900, uMEC (Masimo + Oximax tech)	U401-A(03TL)	Adult finger clip,2.8m	
	U401-B(03TL)	Adult silicone soft tip,2.8m	
	U401-C(03TL)	Pediatric finger clip,2.8m	
	U401-D(03TL)	Pediatric silicone soft tip,2.8m	
	U401-D(03TL-E)	Infant silicone soft tip,2.8m	
	U401-D(03TL-F)	Neonate silicone wrap,2.8m	
	U401-D(03TL-G)	Neonate "Y" type,2.8m	
	U401-A(03TL-H)	Adult ear clip,2.8m	
Mindray (12 pin)			
(BCI tech)	U401-A(03UL)	Adult finger clip,2.8m	
	U401-B(03UL)	Adult silicone soft tip,2.8m	
	U401-C(03UL)	Pediatric finger clip,2.8m	
	U401-D(03UL)	Pediatric silicone soft tip,2.8m	
	U401-D(03UL-E)	Infant silicone soft tip,2.8m	
	U401-D(03UL-F)	Neonate silicone wrap,2.8m	
	U401-D(03UL-G)	Neonate "Y" type,2.8m	
	U401-A(03UL-H)	Adult ear clip,2.8m	
Mindray (12 pin)			
(Masimo tech)	U401-A(03VL)	Adult finger clip,2.8m	
	U401-B(03VL)	Adult silicone soft tip,2.8m	
	U401-C(03VL)	Pediatric finger clip,2.8m	
	U401-D(03VL)	Pediatric silicone soft tip,2.8m	
	U401-D(03VL-E)	Infant silicone soft tip,2.8m	
	U401-D(03VL-F)	Neonate silicone wrap,2.8m	
	U401-D(03VL-G)	Neonate "Y" type,2.8m	
	U401-A(03VL-H)	Adult ear clip,2.8m	
Mindray (12 pin)			
(Nellcor tech)	U401-A(03WL)	Adult finger clip,2.8m	
	U401-B(03WL)	Adult silicone soft tip,2.8m	
	U401-C(03WL)	Pediatric finger clip,2.8m	
	U401-D(03WL)	Pediatric silicone soft tip,2.8m	
	U401-D(03WL-E)	Infant silicone soft tip,2.8m	
	U401-D(03WL-F)	Neonate silicone wrap,2.8m	
	U401-D(03WL-G)	Neonate "Y" type,2.8m	
	U401-A(03WL-H)	Adult ear clip,2.8m	
Mindray (7 pin)			
Mindray PM-60 & PM-60	U401-A(03RL)	Adult finger clip,2.8m	
	U401-B(03RL)	Adult silicone soft tip,2.8m	
	U401-C(03RL)	Pediatric finger clip,2.8m	
	U401-D(03RL)	Pediatric silicone soft tip,2.8m	
	U401-D(03RL-E)	Infant silicone soft tip,2.8m	
	U401-D(03RL-F)	Neonate silicone wrap,2.8m	
	U401-D(03RL-G)	Neonate "Y" type,2.8m	
	U401-A(03RL-H)	Adult ear clip,2.8m	
Masimo (LNOP 6 pin)			
1269 LNOP DCI (Adult Clip) 1276 LNOP DCIP (Pediatric Clip) 1555 LNOP YI (Multi-site) Patient monitors that require LNOP sensors.	U401-A(03RS)	Adult finger clip,0.9m	
	U401-B(03RS)	Adult silicone soft tip,0.9m	
	U401-C(03RS)	Pediatric finger clip,0.9m	
	U401-D(03RS)	Pediatric silicone soft tip,0.9m	
	U401-D(03RS-E)	Infant silicone soft tip,0.9m	
	U401-D(03RS-F)	Neonate silicone wrap,0.9m	
	U401-D(03RS-G)	Neonate "Y" type,0.9m	
	U401-A(03RS-H)	Adult ear clip,0.9m	
Masimo (LNOP 6 pin)			
	U401-A(19AL)	Adult finger clip,2.8m	
	U401-B(19AL)	Adult silicone soft tip,2.8m	
	U401-C(19AL)	Pediatric finger clip,2.8m	
	U401-D(19AL)	Pediatric silicone soft tip,2.8m	
	U401-D(19AL-E)	Infant silicone soft tip,2.8m	
	U401-D(19AL-F)	Neonate silicone wrap,2.8m	
	U401-D(19AL-G)	Neonate "Y" type,2.8m	
	U401-A(19AL-H)	Adult ear clip,2.8m	
Masimo (7 pin)			
LNCS sensors	U401-A(19AS)	Adult finger clip,0.9m	
	U401-B(19AS)	Adult silicone soft tip,0.9m	
	U401-C(19AS)	Pediatric finger clip,0.9m	
	U401-D(19AS)	Pediatric silicone soft tip,0.9m	
	U401-D(19AS-E)	Infant silicone soft tip,0.9m	
	U401-D(19AS-F)	Neonate silicone wrap,0.9m	
	U401-D(19AS-G)	Neonate "Y" type,0.9m	
	U401-A(19AS-H)	Adult ear clip,0.9m	
Masimo (7 pin)			
	U401-A(19BL)	Adult finger clip,2.8m	
	U401-B(19BL)	Adult silicone soft tip,2.8m	
	U401-C(19BL)	Pediatric finger clip,2.8m	
	U401-D(19BL)	Pediatric silicone soft tip,2.8m	
	U401-D(19BL-E)	Infant silicone soft tip,2.8m	
	U401-D(19BL-F)	Neonate silicone wrap,2.8m	
	U401-D(19BL-G)	Neonate "Y" type,2.8m	
	U401-A(19BL-H)	Adult ear clip,2.8m	

Brand/Compatible Models	P/N	Description	Male Connector
Masimo (7 pin)			
LNCS sensors	U401-A(19BS)	Adult finger clip,0.9m	
	U401-B(19BS)	Adult silicone soft tip,0.9m	
	U401-C(19BS)	Pediatric finger clip,0.9m	
	U401-D(19BS)	Pediatric silicone soft tip,0.9m	
	U401-D(19BS-E)	Infant silicone soft tip,0.9m	
	U401-D(19BS-F)	Neonate silicone wrap,0.9m	
	U401-D(19BS-G)	Neonate "Y" type,0.9m	
	U401-A(19BS-H)	Adult ear clip,0.9m	
Masimo (9 pin)			
(Masimo + Oximax tech)	U401-A(19CL)	Adult finger clip,2.8m	
	U401-B(19CL)	Adult silicone soft tip,2.8m	
	U401-C(19CL)	Pediatric finger clip,2.8m	
	U401-D(19CL)	Pediatric silicone soft tip,2.8m	
	U401-D(19CL-E)	Infant silicone soft tip,2.8m	
	U401-D(19CL-F)	Neonate silicone wrap,2.8m	
	U401-D(19CL-G)	Neonate "Y" type,2.8m	
	U401-A(19CL-H)	Adult ear clip,2.8m	
Masimo (9 pin)			
	U401-A(19CS)	Adult finger clip,0.9m	
	U401-B(19CS)	Adult silicone soft tip,0.9m	
	U401-C(19CS)	Pediatric finger clip,0.9m	
	U401-D(19CS)	Pediatric silicone soft tip,0.9m	
	U401-D(19CS-E)	Infant silicone soft tip,0.9m	
	U401-D(19CS-F)	Neonate silicone wrap,0.9m	
	U401-D(19CS-G)	Neonate "Y" type,0.9m	
	U401-A(19CS-H)	Adult ear clip,0.9m	
Masimo (LNOP 8 pin)			

Brand/Compatible Models	P/N	Description	Male Connector
Masimo(14 pin)			
<i>(Masimo Oximax)</i>	U401-A(19HL)	Adult finger clip,2.8m	
	U401-B(19HL)	Adult silicone soft tip,2.8m	
	U401-C(19HL)	Pediatric finger clip,2.8m	
	U401-D(19HL)	Pediatric silicone soft tip,2.8m	
	U401-D(19HL-E)	Infant silicone soft tip,2.8m	
	U401-D(19HL-F)	Neonate silicone wrap,2.8m	
	U401-D(19HL-G)	Neonate "Y" type,2.8m	
	U401-A(19HL-H)	Adult ear clip,2.8m	

Brand/Compatible Models	P/N	Description	Male Connector
Masimo (20 pin)			
	U401-A(19GL)	Adult finger clip,2.8m	
	U401-B(19GL)	Adult silicone soft tip,2.8m	
	U401-C(19GL)	Pediatric finger clip,2.8m	
	U401-D(19GL)	Pediatric silicone soft tip,2.8m	
	U401-D(19GL-E)	Infant silicone soft tip,2.8m	
	U401-D(19GL-F)	Neonate silicone wrap,2.8m	
	U401-D(19GL-G)	Neonate "Y" type,2.8m	
	U401-A(19GL-H)	Adult ear clip,2.8m	

Brand/Compatible Models	P/N	Description	Male Connector
Medtronic Physio-Control (LNOP 6 pin)			
<i>Lifepak 12,20 (Masimo tech)</i>	U401-A(73AS)	Adult finger clip,0.9m	
	U401-B(73AS)	Adult silicone soft tip,0.9m	
	U401-C(73AS)	Pediatric finger clip,0.9m	
	U401-D(73AS)	Pediatric silicone soft tip,0.9m	
	U401-D(73AS-E)	Infant silicone soft tip,0.9m	
	U401-D(73AS-F)	Neonate silicone wrap,0.9m	
	U401-D(73AS-G)	Neonate "Y" type,0.9m	
	U401-A(73AS-H)	Adult ear clip,0.9m	

Brand/Compatible Models	P/N	Description	Male Connector
Medtronic Physio-Control (7 pin)			
<i>Life pak 12,20 (Masimo tech)</i>	U401-A(73BS)	Adult finger clip,0.9m	
	U401-B(73BS)	Adult silicone soft tip,0.9m	
	U401-C(73BS)	Pediatric finger clip,0.9m	
	U401-D(73BS)	Pediatric silicone soft tip,0.9m	
	U401-D(73BS-E)	Infant silicone soft tip,0.9m	
	U401-D(73BS-F)	Neonate silicone wrap,0.9m	
	U401-D(73BS-G)	Neonate "Y" type,0.9m	
	U401-A(73BS-H)	Adult ear clip,0.9m	

Brand/Compatible Models	P/N	Description	Male Connector
Medtronic Physio-Control (7 pin)			
<i>Lifepak 12,20 (Nelcor tech)</i>	U401-A(73CS)	Adult finger clip,0.9m	
	U401-B(73CS)	Adult silicone soft tip,0.9m	
	U401-C(73CS)	Pediatric finger clip,0.9m	
	U401-D(73CS)	Pediatric silicone soft tip,0.9m	
	U401-D(73CS-E)	Infant silicone soft tip,0.9m	
	U401-D(73CS-F)	Neonate silicone wrap,0.9m	
	U401-D(73CS-G)	Neonate "Y" type,0.9m	
	U401-A(73CS-H)	Adult ear clip,0.9m	

Brand/Compatible Models	P/N	Description	Male Connector
Medtronic Physio-Control (14 pin)			
<i>Lifepak 12,20 (Masimo tech)</i>	U401-A(73DL)	Adult finger clip,2.8m	
	U401-B(73DL)	Adult silicone soft tip,2.8m	
	U401-C(73DL)	Pediatric finger clip,2.8m	
	U401-D(73DL)	Pediatric silicone soft tip,2.8m	
	U401-D(73DL-E)	Infant silicone soft tip,2.8m	
	U401-D(73DL-F)	Neonate silicone wrap,2.8m	
	U401-D(73DL-G)	Neonate "Y" type,2.8m	
	U401-A(73DL-H)	Adult ear clip,2.8m	

Brand/Compatible Models	P/N	Description	Male Connector
MEK (6 pin)			
<i>MP 100, MP 110, MP 500, MP 500, MP 800, MP 1000</i>	U401-A(13AL)	Adult finger clip,2.8m	
	U401-B(13AL)	Adult silicone soft tip,2.8m	
	U401-C(13AL)	Pediatric finger clip,2.8m	
	U401-D(13AL)	Pediatric silicone soft tip,2.8m	
	U401-D(13AL-E)	Infant silicone soft tip,2.8m	
	U401-D(13AL-F)	Neonate silicone wrap,2.8m	
	U401-D(13AL-G)	Neonate "Y" type,2.8m	
	U401-A(13AL-H)	Adult ear clip,2.8m	

Brand/Compatible Models	P/N	Description	Male Connector
MEK (6 pin)			
	U401-A(13AS)	Adult finger clip,0.9m	
	U401-B(13AS)	Adult silicone soft tip,0.9m	
	U401-C(13AS)	Pediatric finger clip,0.9m	
	U401-D(13AS)	Pediatric silicone soft tip,0.9m	
	U401-D(13AS-E)	Infant silicone soft tip,0.9m	
	U401-D(13AS-F)	Neonate silicone wrap,0.9m	
	U401-D(13AS-G)	Neonate "Y" type,0.9m	
	U401-A(13AS-H)	Adult ear clip,0.9m	

Brand/Compatible Models	P/N	Description	Male Connector
MEK (7 pin)			
	U401-A(13BL)	Adult finger clip,2.8m	
	U401-B(13BL)	Adult silicone soft tip,2.8m	
	U401-C(13BL)	Pediatric finger clip,2.8m	
	U401-D(13BL)	Pediatric silicone soft tip,2.8m	
	U401-D(13BL-E)	Infant silicone soft tip,2.8m	
	U401-D(13BL-F)	Neonate silicone wrap,2.8m	
	U401-D(13BL-G)	Neonate "Y" type,2.8m	
	U401-A(13BL-H)	Adult ear clip,2.8m	

Brand/Compatible Models	P/N	Description	Male Connector
MEK (8 pin)			
<i>(MEK tech)</i>	U401-A(13CL)	Adult finger clip,2.8m	
	U401-B(13CL)	Adult silicone soft tip,2.8m	
	U401-C(13CL)	Pediatric finger clip,2.8m	
	U401-D(13CL)	Pediatric silicone soft tip,2.8m	
	U401-D(13CL-E)	Infant silicone soft tip,2.8m	
	U401-D(13CL-F)	Neonate silicone wrap,2.8m	
	U401-D(13CL-G)	Neonate "Y" type,2.8m	
	U401-A(13CL-H)	Adult ear clip,2.8m	

Brand/Compatible Models	P/N	Description	Male Connector
MEK (8 pin)			
<i>(Nelcor tech)</i>	U401-A(13DL)	Adult finger clip,2.8m	
	U401-B(13DL)	Adult silicone soft tip,2.8m	
	U401-C(13DL)	Pediatric finger clip,2.8m	
	U401-D(13DL)	Pediatric silicone soft tip,2.8m	
	U401-D(13DL-E)	Infant silicone soft tip,2.8m	
	U401-D(13DL-F)	Neonate silicone wrap,2.8m	
	U401-D(13DL-G)	Neonate "Y" type,2.8m	
	U401-A(13DL-H)	Adult ear clip,2.8m	

Brand/Compatible Models	P/N	Description	Male Connector
MEK (7 pin)			
<i>(Nelcor tech)</i>	U401-A(13EL)	Adult finger clip,2.8m	
	U401-B(13EL)	Adult silicone soft tip,2.8m	
	U401-C(13EL)	Pediatric finger clip,2.8m	
	U401-D(13EL)	Pediatric silicone soft tip,2.8m	
	U401-D(13EL-E)	Infant silicone soft tip,2.8m	
	U401-D(13EL-F)	Neonate silicone wrap,2.8m	
	U401-D(13EL-G)	Neonate "Y" type,2.8m	
	U401-A(13EL-H)	Adult ear clip,2.8m	

Brand/Compatible Models	P/N	Description	Male Connector
Mediana (14 pin)			
<i>Lucon, YM6000, YM1000, YM5500</i>	U401-A(64AL)	Adult finger clip,2.8m	
	U401-B(64AL)	Adult silicone soft tip,2.8m	
	U401-C(64AL)	Pediatric finger clip,2.8m	
	U401-D(64AL)	Pediatric silicone soft tip,2.8m	
	U401-D(64AL-E)	Infant silicone soft tip,2.8m	
	U401-D(64AL-F)	Neonate silicone wrap,2.8m	
	U401-D(64AL-G)	Neonate "Y" type,2.8m	
	U401-A(64AL-H)	Adult ear clip,2.8m	

Brand/Compatible Models	P/N	Description	Male Connector
Medica D (8 pin)			
<i>Medica D Login2000, OTW3000, Taurus-B</i>	U401-A(64AL)	Adult finger clip,2.8m	
	U401-B(64AL)	Adult silicone soft tip,2.8m	
	U401-C(64AL)	Pediatric finger clip,2.8m	
	U401-D(64AL)	Pediatric silicone soft tip,2.8m	
	U401-D(64AL-E)	Infant silicone soft tip,2.8m	
	U401-D(64AL-F)	Neonate silicone wrap,2.8m	
	U401-D(64AL-G)	Neonate "Y" type,2.8m	
	U401-A(64AL-H)	Adult ear clip,2.8m	

Brand/Compatible Models	P/N	Description	Male Connector
M&B (6 pin)			
<i>M&B-CD2000, MB526T</i>	U401-A(17AL)	Adult finger clip,2.8m	
	U401-B(17AL)	Adult silicone soft tip,2.8m	
	U401-C(17AL)	Pediatric finger clip,2.8m	
	U401-D(17AL)	Pediatric silicone soft tip,2.8m	
	U401-D(17AL-E)	Infant silicone soft tip,2.8m	
	U401-D(17AL-F)	Neonate silicone wrap,2.8m	
	U401-D(17AL-G)	Neonate "Y" type,2.8m	
	U401-A(17AL-H)	Adult ear clip,2.8m	

Brand/Compatible Models	P/N	Description	Male Connector
M&B (7 pin)			
<i>M&B526+Ohmeda Module</i>	U401-A(17BL)	Adult finger clip,2.8m	
	U401-B(17BL)	Adult silicone soft tip,2.8m	
	U401-C(17BL)	Pediatric finger clip,2.8m	
	U401-D(17BL)	Pediatric silicone soft tip,2.8m	
	U401-D(17BL-E)	Infant silicone soft tip,2.8m	
	U401-D(17BL-F)	Neonate silicone wrap,2.8m	
	U401-D(17BL-G)	Neonate "Y" type,2.8m	
	U401-A(17BL-H)	Adult ear clip,2.8m	

Brand/Compatible Models	P/N	Description	Male Connector
M&B (7 pin)			
<i>M&B 800-HS</i>	U401-A(17CL)	Adult finger clip,2.8m	
	U401-B(17CL)	Adult silicone soft tip,2.8m	
	U401-C(17CL)	Pediatric finger clip,2.8m	
	U401-D(17CL)	Pediatric silicone soft tip,2.8m	
	U401-D(17CL-E)	Infant silicone soft tip,2.8m	
	U401-D(17CL-F)	Neonate silicone wrap,2.8m	
	U401-D(17CL-G)	Neonate "Y" type,2.8m	
	U401-A(17CL-H)	Adult ear clip,2.8m	

Brand/Compatible Models	P/N	Description	Male Connector
Mennen (8 pin)			
	U401-A(20AL)	Adult finger clip,2.8m	
	U401-B(20AL)	Adult silicone soft tip,2.8m	
	U401-C(20AL)	Pediatric finger clip,2.8m	
	U401-D(20AL)	Pediatric silicone soft tip,2.8m	
	U401-D(20AL-E)	Infant silicone soft tip,2.8m	
	U401-D(20AL-F)	Neonate silicone wrap,2.8m	
	U401-D(20AL-G)	Neonate "Y" type,2.8m	
	U401-A(20AL-H)	Adult ear clip,2.8m	

Brand/Compatible Models	P/N	Description	Male Connector
Mennen (6 pin 40°)			
<i>(Digital tech)</i>	U401-A(20BL)	Adult finger clip,2.8m	
	U401-B(20BL)	Adult silicone soft tip,2.8m	
	U401-C(20BL)	Pediatric finger clip,2.8m	
	U401-D(20BL)	Pediatric silicone soft tip,2.8m	
	U401-D(20BL-E)	Infant silicone soft tip,2.8m	
	U401-D(20BL-F)	Neonate silicone wrap,2.8m	
	U401-D(20BL-G)	Neonate "Y" type,2.8m	
	U401-A(20BL-H)	Adult ear clip,2.8m	

Brand/Compatible Models	P/N	Description	Male Connector
Mennen (12 pin)			
<i>(Oximax tech)</i>	U401-A(20CL)	Adult finger clip,2.8m	
	U401-B(20CL)	Adult silicone soft tip,2.8m	
	U401-C(20CL)	Pediatric finger clip,2.8m	
	U401-D(20CL)	Pediatric silicone soft tip,2.8m	
	U401-D(20CL-E)	Infant silicone soft tip,2.8m	
	U401-D(20CL-F)	Neonate silicone wrap,2.8m	
	U401-D(20CL-G)	Neonate "Y" type,2.8m	
	U401-A(20CL-H)	Adult ear clip,2.8m	

Brand/Compatible Models	P/N	Description	Male Connector
Nelcor (7 pin)			
<i>Nelcor: N100,N180,N200,N-20,NPB-50,NPB-75,NPB-290,NPB-295,N-390,N-395,N-3000,N-6000. (Non-Oximax tech)</i>	U401-A(01AL)	Adult finger clip,2.8m	
	U401-B(01AL)	Adult silicone soft tip,2.8m	
	U401-C(01AL)	Pediatric finger clip,2.8m	
	U401-D(01AL)	Pediatric silicone soft tip,2.8m	
	U401-D(01AL-E)	Infant silicone soft tip,2.8m	
	U401-D(01AL-F)	Neonate silicone wrap,2.8m	
	U401-D(01AL-G)	Neonate "Y" type,2.8m	
	U401-A(01AL-H)	Adult ear clip,2.8m	
	U401-A(01AS)	Adult finger clip,0.9m	
	U401-B(01AS)	Adult silicone soft tip,0.9m	
	U401-C(01AS)	Pediatric finger clip,0.9m	
	U401-D(01AS)	Pediatric silicone soft tip,0.9m	
	U401-D(01AS-E)	Infant silicone soft tip,0.9m	

Brand/Compatible Models	P/N	Description	Male Connector
Nelcor (9 pin)			
<i>All Nelcor & Nelcor equipped, including NBP195. (Oximax tech)</i>	U401-A(01BL)	Adult finger clip,2.8m	
	U401-B(01BL)	Adult silicone soft tip,2.8m	
	U401-C(01BL)	Pediatric finger clip,2.8m	
	U401-D(01BL)	Pediatric silicone soft tip,2.8m	
	U401-D(01BL-E)	Infant silicone soft tip,2.8m	
	U401-D(01BL-F)	Neonate silicone wrap,2.8m	
	U401-D(01BL-G)	Neonate "Y" type,2.8m	
	U401-A(01BL-H)	Adult ear clip,2.8m	
	U401-A(01BS)	Adult finger clip,0.9m	
	U401-B(01BS)	Adult silicone soft tip,0.9m	
	U401-C(01BS)	Pediatric finger clip,0.9m	
	U401-D(01BS)	Pediatric silicone soft tip,0.9m	
	U401-D(01BS-E)	Infant silicone soft tip,0.9m	

Brand/Compatible Models	P/N	Description	Male Connector
Nelcor (14 pin)			
<i>Nelcor Oximax: N-560,N-595,N-600,N-600x,Huntleigh monitors and Cardio Aid 200 Defibrillators. (Oximax tech)</i>	U401-A(01CL)	Adult finger clip,2.8m	
	U401-B(01CL)	Adult silicone soft tip,2.8m	
	U401-C(01CL)	Pediatric finger clip,2.8m	
	U401-D(01CL)	Pediatric silicone soft tip,2.8m	
	U401-D(01CL-E)	Infant silicone soft tip,2.8m	
	U401-D(01CL-F)	Neonate silicone wrap,2.8m	
	U401-D(01CL-G)	Neonate "Y" type,2.8m	
	U401-A(01CL-H)	Adult ear clip,2.8m	

Brand/Compatible Models	P/N	Description	Male Connector
Nelcor (14 pin)			
<i>Datascope: Accutor plus (nelcor), Nelcor: NPB-290/5,N-390,N-395,N3000,N6000,NPB-290/5,N-390,N-395,N3000,N6000 Nihon Kohden: BSM-5105A,BSM-5115A, Colin BP88/306. (Non-Oximax tech)</i>	U401-A(01DL)	Adult finger clip,2.8m	
	U401-B(01DL)	Adult silicone soft tip,2.8m	
	U401-C(01DL)	Pediatric finger clip,2.8m	
	U401-D(01DL)	Pediatric silicone soft tip,2.8m	
	U401-D(01DL-E)	Infant silicone soft tip,2.8m	
	U401-D(01DL-F)	Neonate silicone wrap,2.8m	
	U401-D(01DL-G)	Neonate "Y" type,2.8m	
	U401-A(01DL-H)	Adult ear clip,2.8m	

Brand/Compatible Models	P/N	Description	Male Connector
Nihon Kohden (9 pin)			
<i>Nihon Kohden: BSM5101,5103,5111,5113 Life scope P,BSM-5105,5135 Life scope A,BSM-2351,2353 Life scope L,BSM-2301,2303,Life scope I</i>	U401-A(05AL)	Adult finger clip,2.8m	
	U401-B(05AL)	Adult silicone soft tip,2.8m	
	U401-C(05AL)	Pediatric finger clip,2.8m	
	U401-D(05AL)	Pediatric silicone soft tip,2.8m	
	U401-D(05AL-E)	Infant silicone soft tip,2.8m	
	U401-D(05AL-F)	Neonate silicone wrap,2.8m	
	U401-D(05AL-G)	Neonate "Y" type,2.8m	
	U401-A(05AL-H)	Adult ear clip,2.8m	

N~P

Brand/Compatible Models	P/N	Description	Male Connector	
Newtech / GMI (7 pin)				
(Digital tech)	U401-A(40DL)	Adult finger clip,2.8m		
	U401-B(40DL)	Adult silicone soft tip,2.8m		
	U401-C(40DL)	Pediatric finger clip,2.8m		
	U401-D(40DL)	Pediatric silicone soft tip,2.8m		
	U401-D(40DL-E)	Infant silicone soft tip,2.8m		
	U401-D(40DL-F)	Neonate silicone wrap,2.8m		
	U401-D(40DL-G)	Neonate "Y" type,2.8m		
	U401-A(40DL-H)	Adult ear clip,2.8m		
	U401-A(40DS)	Adult finger clip,0.9m		
	U401-B(40DS)	Adult silicone soft tip,0.9m		
	U401-C(40DS)	Pediatric finger clip,0.9m		
	U401-D(40DS)	Pediatric silicone soft tip,0.9m		
	U401-D(40DS-E)	Infant silicone soft tip,0.9m		
	U401-D(40DS-F)	Neonate silicone wrap,0.9m		
	U401-D(40DS-G)	Neonate "Y" type,0.9m		
	U401-A(40DS-H)	Adult ear clip,0.9m		
	Newtech / GMI (8 pin)			
NT2A	U401-A(40EL)	Adult finger clip,2.8m		
	U401-B(40EL)	Adult silicone soft tip,2.8m		
	U401-C(40EL)	Pediatric finger clip,2.8m		
	U401-D(40EL)	Pediatric silicone soft tip,2.8m		
	U401-D(40EL-E)	Infant silicone soft tip,2.8m		
	U401-D(40EL-F)	Neonate silicone wrap,2.8m		
	U401-D(40EL-G)	Neonate "Y" type,2.8m		
U401-A(40EL-H)	Adult ear clip,2.8m			
Newtech / GMI (12 pin)				
NT3A,NT3B,NT3E,NT3F,NT360 (Digital tech)	U401-A(40FL)		Adult finger clip,2.8m	
	U401-B(40FL)		Adult silicone soft tip,2.8m	
	U401-C(40FL)		Pediatric finger clip,2.8m	
	U401-D(40FL)		Pediatric silicone soft tip,2.8m	
	U401-D(40FL-E)		Infant silicone soft tip,2.8m	
	U401-D(40FL-F)		Neonate silicone wrap,2.8m	
	U401-D(40FL-G)	Neonate "Y" type,2.8m		
U401-A(40FL-H)	Adult ear clip,2.8m	NT3B (Oximax tech)		
Newtech / GMI (12 pin)				
NT3B (Oximax tech)	U401-A(40JL)		Adult finger clip,2.8m	
	U401-B(40JL)		Adult silicone soft tip,2.8m	
	U401-C(40JL)		Pediatric finger clip,2.8m	
	U401-D(40JL)		Pediatric silicone soft tip,2.8m	
	U401-D(40JL-E)		Infant silicone soft tip,2.8m	
	U401-D(40JL-F)	Neonate silicone wrap,2.8m		
	U401-D(40JL-G)	Neonate "Y" type,2.8m		
U401-A(40JL-H)	Adult ear clip,2.8m	Newtech / GMI (12 pin)		
NT3B (Oximax tech)	U401-A(40GL)		Adult finger clip,2.8m	
	U401-B(40GL)		Adult silicone soft tip,2.8m	
	U401-C(40GL)		Pediatric finger clip,2.8m	
	U401-D(40GL)		Pediatric silicone soft tip,2.8m	
	U401-D(40GL-E)		Infant silicone soft tip,2.8m	
	U401-D(40GL-F)		Neonate silicone wrap,2.8m	
	U401-D(40GL-G)	Neonate "Y" type,2.8m		
U401-A(40GL-H)	Adult ear clip,2.8m	Newtech / GMI (8 pin)		
(Oximax tech)	U401-A(40HL)		Adult finger clip,2.8m	
	U401-B(40HL)		Adult silicone soft tip,2.8m	
	U401-C(40HL)		Pediatric finger clip,2.8m	
	U401-D(40HL)		Pediatric silicone soft tip,2.8m	
	U401-D(40HL-E)		Infant silicone soft tip,2.8m	
	U401-D(40HL-F)		Neonate silicone wrap,2.8m	
	U401-D(40HL-G)	Neonate "Y" type,2.8m		
U401-A(40HL-H)	Adult ear clip,2.8m	Nonin (6 pin)		
8605,8605D	U401-A(21AL)		Adult finger clip,2.8m	
	U401-B(21AL)		Adult silicone soft tip,2.8m	
	U401-C(21AL)		Pediatric finger clip,2.8m	
	U401-D(21AL)		Pediatric silicone soft tip,2.8m	
	U401-D(21AL-E)		Infant silicone soft tip,2.8m	
	U401-D(21AL-F)		Neonate silicone wrap,2.8m	
	U401-D(21AL-G)	Neonate "Y" type,2.8m		
U401-A(21AL-H)	Adult ear clip,2.8m	Nonin (8 pin)		
Nonin:8500,8600,8700,8800,9600,9700	U401-A(21BL)		Adult finger clip,2.8m	
	U401-B(21BL)		Adult silicone soft tip,2.8m	
	U401-C(21BL)		Pediatric finger clip,2.8m	
	U401-D(21BL)		Pediatric silicone soft tip,2.8m	
	U401-D(21BL-E)		Infant silicone soft tip,2.8m	
	U401-D(21BL-F)		Neonate silicone wrap,2.8m	
	U401-D(21BL-G)	Neonate "Y" type,2.8m		
U401-A(21BL-H)	Adult ear clip,2.8m			

Brand/Compatible Models	P/N	Description	Male Connector		
Nonin (9 pin)					
Nonin:8500,8600,8700,8800,2500	U401-A(21CL)	Adult finger clip,2.8m			
	U401-B(21CL)	Adult silicone soft tip,2.8m			
	U401-C(21CL)	Pediatric finger clip,2.8m			
	U401-D(21CL)	Pediatric silicone soft tip,2.8m			
	U401-D(21CL-E)	Infant silicone soft tip,2.8m			
	U401-D(21CL-F)	Neonate silicone wrap,2.8m			
	U401-D(21CL-G)	Neonate "Y" type,2.8m			
	U401-A(21CL-H)	Adult ear clip,2.8m			
	Novamatrix (7 pin)				
	Novamatrix:505,510,511,515B/C,520,7000,7100,Oxyleth; Spacelabs 90351D/G,90565,90566,90567,90568,90651-07/08,90519-01,90651A-07	U401-A(16AL)		Adult finger clip,2.8m	
		U401-B(16AL)		Adult silicone soft tip,2.8m	
		U401-C(16AL)		Pediatric finger clip,2.8m	
		U401-D(16AL)		Pediatric silicone soft tip,2.8m	
		U401-D(16AL-E)		Infant silicone soft tip,2.8m	
		U401-D(16AL-F)		Neonate silicone wrap,2.8m	
		U401-D(16AL-G)		Neonate "Y" type,2.8m	
	U401-A(16AL-H)	Adult ear clip,2.8m			
Novamatrix (6 pin)					
Novamatrix:505,510,511,515B/C,520,7000,7100,Oxyleth; Spacelabs 90351D/G,90565,90566,90567,90568,90651-07/08,90519-01,90651A-07	U401-A(16BS)	Adult finger clip,0.9m			
	U401-B(16BS)	Adult silicone soft tip,0.9m			
	U401-C(16BS)	Pediatric finger clip,0.9m			
	U401-D(16BS)	Pediatric silicone soft tip,0.9m			
	U401-D(16BS-E)	Infant silicone soft tip,0.9m			
	U401-D(16BS-F)	Neonate silicone wrap,0.9m			
	U401-D(16BS-G)	Neonate "Y" type,0.9m			
	U401-A(16BS-H)	Adult ear clip,0.9m			
Novamatrix (9 pin)					
512 pulse oximeter	U401-A(16CS)	Adult finger clip,0.9m			
	U401-B(16CS)	Adult silicone soft tip,0.9m			
	U401-C(16CS)	Pediatric finger clip,0.9m			
	U401-D(16CS)	Pediatric silicone soft tip,0.9m			
	U401-D(16CS-E)	Infant silicone soft tip,0.9m			
	U401-D(16CS-F)	Neonate silicone wrap,0.9m			
	U401-D(16CS-G)	Neonate "Y" type,0.9m			
	U401-D(16CS-H)	Adult ear clip,0.9m			
	Neusoft (6 pin)				
Neusoft (6 pin)	U401-A(51AL)	Adult finger clip,2.8m			
	U401-B(51AL)	Adult silicone soft tip,2.8m			
	U401-C(51AL)	Pediatric finger clip,2.8m			
	U401-D(51AL)	Pediatric silicone soft tip,2.8m			
	U401-D(51AL-E)	Infant silicone soft tip,2.8m			
	U401-D(51AL-F)	Neonate silicone wrap,2.8m			
	U401-D(51AL-G)	Neonate "Y" type,2.8m			
	U401-D(51AL-H)	Adult ear clip,2.8m			
	Neusoft (5 pin)				
NSC-M10 (Digital tech)	U401-A(51BL)	Adult finger clip,2.8m			
	U401-B(51BL)	Adult silicone soft tip,2.8m			
	U401-C(51BL)	Pediatric finger clip,2.8m			
	U401-D(51BL)	Pediatric silicone soft tip,2.8m			
	U401-D(51BL-E)	Infant silicone soft tip,2.8m			
	U401-D(51BL-F)	Neonate silicone wrap,2.8m			
	U401-D(51BL-G)	Neonate "Y" type,2.8m			
	U401-A(51BL-H)	Adult ear clip,2.8m			
	Penlon (7 pin)				
Penlon Intermed Patient monitor (Nelcor tech)	U401-A(63AL)	Adult finger clip,2.8m			
	U401-B(63AL)	Adult silicone soft tip,2.8m			
	U401-C(63AL)	Pediatric finger clip,2.8m			
	U401-D(63AL)	Pediatric silicone soft tip,2.8m			
	U401-D(63AL-E)	Infant silicone soft tip,2.8m			
	U401-D(63AL-F)	Neonate silicone wrap,2.8m			
	U401-D(63AL-G)	Neonate "Y" type,2.8m			
	U401-A(63AL-H)	Adult ear clip,2.8m			
	Penlon (7 pin)				
Penlon Intermed Patient monitor (Masimo tech)	U401-A(63BL)	Adult finger clip,2.8m			
	U401-B(63BL)	Adult silicone soft tip,2.8m			
	U401-C(63BL)	Pediatric finger clip,2.8m			
	U401-D(63BL)	Pediatric silicone soft tip,2.8m			
	U401-D(63BL-E)	Infant silicone soft tip,2.8m			
	U401-D(63BL-F)	Neonate silicone wrap,2.8m			
	U401-D(63BL-G)	Neonate "Y" type,2.8m			
	U401-A(63BL-H)	Adult ear clip,2.8m			

Brand/Compatible Models	P/N	Description	Male Connector		
Philips (8 pin)					
Viridia 25C, C1, C3, M3, M5, MP20, MP30, MP50, MP50, MP70, MP80, VM5, VM6, VM8. (Philips/Nellcor tech)	U401-A(04AL)	Adult finger clip,2.8m			
	U401-B(04AL)	Adult silicone soft tip,2.8m			
	U401-C(04AL)	Pediatric finger clip,2.8m			
	U401-D(04AL)	Pediatric silicone soft tip,2.8m			
	U401-D(04AL-E)	Infant silicone soft tip,2.8m			
	U401-D(04AL-F)	Neonate silicone wrap,2.8m			
	U401-D(04AL-G)	Neonate "Y" type,2.8m			
	U401-A(04AL-H)	Adult ear clip,2.8m			
	Philips (8 pin)				
	Viridia 25C, C1, C3, M3, M5, MP20, MP30, MP50, MP50, MP70, MP80, VM5, VM6, VM8. (Masimo tech)	U401-A(04AS)		Adult finger clip,1.5m	
		U401-B(04AS)		Adult silicone soft tip,1.5m	
		U401-C(04AS)		Pediatric finger clip,1.5m	
		U401-D(04AS)		Pediatric silicone soft tip,1.5m	
		U401-D(04AS-E)		Infant silicone soft tip,1.5m	
		U401-D(04AS-F)		Neonate silicone wrap,1.5m	
		U401-D(04AS-G)		Neonate "Y" type,1.5m	
		U401-A(04AS-H)		Adult ear clip,1.5m	
Philips (8 pin)					
Viridia 25C, C1, C3, M3, M5, MP20, MP30, MP50, MP50, MP70, MP80, VM5, VM6, VM8. (Masimo tech)		U401-A(04BL)	Adult finger clip,2.8m		
	U401-B(04BL)	Adult silicone soft tip,2.8m			
	U401-C(04BL)	Pediatric finger clip,2.8m			
	U401-D(04BL)	Pediatric silicone soft tip,2.8m			
	U401-D(04BL-E)	Infant silicone soft tip,2.8m			
	U401-D(04BL-F)	Neonate silicone wrap,2.8m			
	U401-D(04BL-G)	Neonate "Y" type,2.8m			
	U401-A(04BL-H)	Adult ear clip,2.8m			
	Philips (8 pin)				
	Viridia 25C, C1, C3, M3, M5, MP20, MP30, MP50, MP50, MP70, MP80, VM5, VM6, VM8. (Oximax tech)	U401-A(04BS)	Adult finger clip,1.5m		
U401-B(04BS)		Adult silicone soft tip,1.5m			
U401-C(04BS)		Pediatric finger clip,1.5m			
U401-D(04BS)		Pediatric silicone soft tip,1.5m			
U401-D(04BS-E)		Infant silicone soft tip,1.5m			
U401-D(04BS-F)		Neonate silicone wrap,1.5m			
U401-D(04BS-G)		Neonate "Y" type,1.5m			
U401-A(04BS-H)		Adult ear clip,1.5m			
Philips (8 pin)					
Viridia 25C, C1, C3, M3, M5, MP20, MP30, MP50, MP50, MP70, MP80, VM5, VM6, VM8. (Oximax tech)		U401-A(04CL)	Adult finger clip,2.8m		
	U401-B(04CL)	Adult silicone soft tip,2.8m			
	U401-C(04CL)	Pediatric finger clip,2.8m			
	U401-D(04CL)	Pediatric silicone soft tip,2.8m			
	U401-D(04CL-E)	Infant silicone soft tip,2.8m			
	U401-D(04CL-F)	Neonate silicone wrap,2.8m			
	U401-D(04CL-G)	Neonate "Y" type,2.8m			
	U401-A(04CL-H)	Adult ear clip,2.8m			
	Philips (12 pin)				
Philips 78352A/C, 78355A/C, 78835C, M1020A, M1025A/B, M1205A, M1350B, M1722A/B, M1723A/B, M2575B, V25. (Philips/Nellcor tech)	U401-A(04DL)	Adult finger clip,2.8m			
	U401-B(04DL)	Adult silicone soft tip,2.8m			
	U401-C(04DL)	Pediatric finger clip,2.8m			
	U401-D(04DL)	Pediatric silicone soft tip,2.8m			
	U401-D(04DL-E)	Infant silicone soft tip,2.8m			
	U401-D(04DL-F)	Neonate silicone wrap,2.8m			
	U401-D(04DL-G)	Neonate "Y" type,2.8m			
	U401-A(04DL-H)	Adult ear clip,2.8m			
	Philips (12 pin)				
Philips 78352A/C, 78355A/C, 78835C, M1020A, M1025A/B, M1205A, M1350B, M1722A/B, M1723A/B, M2575B, V25. (Masimo tech)	U401-A(04EL)	Adult finger clip,2.8m			
	U401-B(04EL)	Adult silicone soft tip,2.8m			
	U401-C(04EL)	Pediatric finger clip,2.8m			
	U401-D(04EL)	Pediatric silicone soft tip,2.8m			
	U401-D(04EL-E)	Infant silicone soft tip,2.8m			
	U401-D(04EL-F)	Neonate silicone wrap,2.8m			
	U401-D(04EL-G)	Neonate "Y" type,2.8m			
	U401-A(04EL-H)	Adult ear clip,2.8m			
	Palco (6 pin)				
Palco (6 pin)	U401-A(31AL)	Adult finger clip,2.8m			
	U401-B(31AL)	Adult silicone soft tip,2.8m			
	U401-C(31AL)	Pediatric finger clip,2.8m			
	U401-D(31AL)	Pediatric silicone soft tip,2.8m			
	U401-D(31AL-E)	Infant silicone soft tip,2.8m			
	U401-D(31AL-F)	Neonate silicone wrap,2.8m			
	U401-D(31AL-G)	Neonate "Y" type,2.8m			
	U401-A(31AL-H)	Adult ear clip,2.8m			
	Palco (8 pin)				
Palco (8 pin)	U401-A(31BL)	Adult finger clip,2.8m			
	U401-B(31BL)	Adult silicone soft tip,2.8m			
	U401-C(31BL)	Pediatric finger clip,2.8m			
	U401-D(31BL)	Pediatric silicone soft tip,2.8m			
	U401-D(31BL-E)	Infant silicone soft tip,2.8m			
	U401-D(31BL-F)	Neonate silicone wrap,2.8m			
	U401-D(31BL-G)	Neonate "Y" type,2.8m			
	U401-A(31BL-H)	Adult ear clip,2.8m			

Brand/Compatible Models	P/N	Description	Male Connector
Risingmed (5 pin)			
RMP9000C	U401-A(88AL)	Adult finger clip,2.8m	
	U401-B(88AL)	Adult silicone soft tip,2.8m	
	U401-C(88AL)	Pediatric finger clip,2.8m	
	U401-D(88AL)	Pediatric silicone soft tip,2.8m	
	U401-D(88AL-E)	Infant silicone soft tip,2.8m	
	U401-D(88AL-F)	Neonate silicone wrap,2.8m	
	U401-D(88AL-G)	Neonate "Y" type,2.8m	
Spacelabs (7 pin)			
Spacelabs Medical: 90351-06, 90309, 90565, 0566, 90589, 90651-A, IM77, 90308, PC Scout	U401-A(07AL)	Adult finger clip,2.8m	
	U401-B(07AL)	Adult silicone soft tip,2.8m	
	U401-C(07AL)	Pediatric finger clip,2.8m	
	U401-D(07AL)	Pediatric silicone soft tip,2.8m	
	U401-D(07AL-E)	Infant silicone soft tip,2.8m	
	U401-D(07AL-F)	Neonate silicone wrap,2.8m	
	U401-D(07AL-G)	Neonate "Y" type,2.8m	
Spacelabs (10 pin)			
Spacelabs 1050, 1600, 1700, 90367, 90369, 90569, 90566, Ultraview, 91220, 91369, mCare 300.	U401-A(07BL)	Adult finger clip,2.8m	
	U401-B(07BL)	Adult silicone soft tip,2.8m	
	U401-C(07BL)	Pediatric finger clip,2.8m	
	U401-D(07BL)	Pediatric silicone soft tip,2.8m	
	U401-D(07BL-E)	Infant silicone soft tip,2.8m	
	U401-D(07BL-F)	Neonate silicone wrap,2.8m	
	U401-D(07BL-G)	Neonate "Y" type,2.8m	
Spacelabs (10 pin)			
Spacelabs 1050, 1600, 1700, 90367, 90369, 90569, 90566, Ultraview, 91220, 91369, mCare 300. (Oximax tech)	U401-A(07CL)	Adult finger clip,2.8m	
	U401-B(07CL)	Adult silicone soft tip,2.8m	
	U401-C(07CL)	Pediatric finger clip,2.8m	
	U401-D(07CL)	Pediatric silicone soft tip,2.8m	
	U401-D(07CL-E)	Infant silicone soft tip,2.8m	
	U401-D(07CL-F)	Neonate silicone wrap,2.8m	
	U401-D(07CL-G)	Neonate "Y" type,2.8m	
Spacelabs (10 pin)			
Spacelabs 1050, 1600, 1700, 90367, 90369, 90569, 90566, Ultraview, 91220, 91369, mCare 300. (Oximax tech)	U401-A(07DL)	Adult finger clip,2.8m	
	U401-B(07DL)		

Brand/Compatible Models	P/N	Description	Male Connector
Siemens Drager (10 pin)			
Siemens Medical: Sirecust 700, Sirecust 630, Sirem SpO2 Module	U401-A(15DL)	Adult finger clip,2.8m	
	U401-B(15DL)	Adult silicone soft tip,2.8m	
	U401-C(15DL)	Pediatric finger clip,2.8m	
	U401-D(15DL)	Pediatric silicone soft tip,2.8m	
	U401-D(15DL-E)	Infant silicone soft tip,2.8m	
	U401-D(15DL-F)	Neonate silicone wrap,2.8m	
	U401-D(15DL-G)	Neonate "Y" type,2.8m	
	U401-A(15DL-H)	Adult ear clip,2.8m	
Siemens Drager (8 pin)			
Drager medical: Vitalert 1000, Cicero	U401-A(15FL)	Adult finger clip,2.8m	
	U401-B(15FL)	Adult silicone soft tip,2.8m	
	U401-C(15FL)	Pediatric finger clip,2.8m	
	U401-D(15FL)	Pediatric silicone soft tip,2.8m	
	U401-D(15FL-E)	Infant silicone soft tip,2.8m	
	U401-D(15FL-F)	Neonate silicone wrap,2.8m	
	U401-D(15FL-G)	Neonate "Y" type,2.8m	
	U401-A(15FL-H)	Adult ear clip,2.8m	
Siemens Drager (6 pin 40°)			
Drager Siemens Vista 120	U401-A(15GL)	Adult finger clip,2.8m	
	U401-B(15GL)	Adult silicone soft tip,2.8m	
	U401-C(15GL)	Pediatric finger clip,2.8m	
	U401-D(15GL)	Pediatric silicone soft tip,2.8m	
	U401-D(15GL-E)	Infant silicone soft tip,2.8m	
	U401-D(15GL-F)	Neonate silicone wrap,2.8m	
	U401-D(15GL-G)	Neonate "Y" type,2.8m	
	U401-A(15GL-H)	Adult ear clip,2.8m	
S&W (10 pin)			
S&W (Diascope G2) monitor, Diascope 1, 2 and 3,8000	U401-A(32AL)	Adult finger clip,2.8m	
	U401-B(32AL)	Adult silicone soft tip,2.8m	
	U401-C(32AL)	Pediatric finger clip,2.8m	
	U401-D(32AL)	Pediatric silicone soft tip,2.8m	
	U401-D(32AL-E)	Infant silicone soft tip,2.8m	
	U401-D(32AL-F)	Neonate silicone wrap,2.8m	
	U401-D(32AL-G)	Neonate "Y" type,2.8m	
	U401-A(32AL-H)	Adult ear clip,2.8m	
Schiller (6 pin)			
Truscope	U401-A(25AL)	Adult finger clip,2.8m	
	U401-B(25AL)	Adult silicone soft tip,2.8m	
	U401-C(25AL)	Pediatric finger clip,2.8m	
	U401-D(25AL)	Pediatric silicone soft tip,2.8m	
	U401-D(25AL-E)	Infant silicone soft tip,2.8m	
	U401-D(25AL-F)	Neonate silicone wrap,2.8m	
	U401-D(25AL-G)	Neonate "Y" type,2.8m	
	U401-A(25AL-H)	Adult ear clip,2.8m	
Schiller (7 pin)			
Schiller Argus CM8, SM783, SM785, SM785, TM910 (Nelcor tech)	U401-A(25BL)	Adult finger clip,2.8m	
	U401-B(25BL)	Adult silicone soft tip,2.8m	
	U401-C(25BL)	Pediatric finger clip,2.8m	
	U401-D(25BL)	Pediatric silicone soft tip,2.8m	
	U401-D(25BL-E)	Infant silicone soft tip,2.8m	
	U401-D(25BL-F)	Neonate silicone wrap,2.8m	
	U401-D(25BL-G)	Neonate "Y" type,2.8m	
	U401-A(25BL-H)	Adult ear clip,2.8m	
Schiller (7 pin)			
ASAT,S-50/100/100A (Masimo tech)	U401-A(25CL)	Adult finger clip,2.8m	
	U401-B(25CL)	Adult silicone soft tip,2.8m	
	U401-C(25CL)	Pediatric finger clip,2.8m	
	U401-D(25CL)	Pediatric silicone soft tip,2.8m	
	U401-D(25CL-E)	Infant silicone soft tip,2.8m	
	U401-D(25CL-F)	Neonate silicone wrap,2.8m	
	U401-D(25CL-G)	Neonate "Y" type,2.8m	
	U401-A(25CL-H)	Adult ear clip,2.8m	
Schiller (8 pin)			
LCM New Argus (Oximax tech)	U401-A(25DL)	Adult finger clip,2.8m	
	U401-B(25DL)	Adult silicone soft tip,2.8m	
	U401-C(25DL)	Pediatric finger clip,2.8m	
	U401-D(25DL)	Pediatric silicone soft tip,2.8m	
	U401-D(25DL-E)	Infant silicone soft tip,2.8m	
	U401-D(25DL-F)	Neonate silicone wrap,2.8m	
	U401-D(25DL-G)	Neonate "Y" type,2.8m	
	U401-A(25DL-H)	Adult ear clip,2.8m	
Schiller (8 pin)			
Argus LCM Plus (Masimo + Oximax tech)	U401-A(25GL)	Adult finger clip,2.8m	
	U401-B(25GL)	Adult silicone soft tip,2.8m	
	U401-C(25GL)	Pediatric finger clip,2.8m	
	U401-D(25GL)	Pediatric silicone soft tip,2.8m	
	U401-D(25GL-E)	Infant silicone soft tip,2.8m	
	U401-D(25GL-F)	Neonate silicone wrap,2.8m	
	U401-D(25GL-G)	Neonate "Y" type,2.8m	
	U401-A(25GL-H)	Adult ear clip,2.8m	

Brand/Compatible Models	P/N	Description	Male Connector		
Schiller (12 pin)					
Argus LSM (Oximax tech)	U401-A(25EL)	Adult finger clip,2.8m			
	U401-B(25EL)	Adult silicone soft tip,2.8m			
	U401-C(25EL)	Pediatric finger clip,2.8m			
	U401-D(25EL)	Pediatric silicone soft tip,2.8m			
	U401-D(25EL-E)	Infant silicone soft tip,2.8m			
	U401-D(25EL-F)	Neonate silicone wrap,2.8m			
	U401-D(25EL-G)	Neonate "Y" type,2.8m			
	U401-A(25EL-H)	Adult ear clip,2.8m			
	Schiller (12 pin)				
	(Masimo + Oximax tech)	U401-A(25FL)		Adult finger clip,2.8m	
U401-B(25FL)		Adult silicone soft tip,2.8m			
U401-C(25FL)		Pediatric finger clip,2.8m			
U401-D(25FL)		Pediatric silicone soft tip,2.8m			
U401-D(25FL-E)		Infant silicone soft tip,2.8m			
U401-D(25FL-F)		Neonate silicone wrap,2.8m			
U401-D(25FL-G)		Neonate "Y" type,2.8m			
U401-A(25FL-H)		Adult ear clip,2.8m			
Sinohero (5 pin)					
Diona Pms-8100I, RIS300/IRISS00, Phoebe PMS8300/8310, Phoebepropms8300/8310 pms8110A		U401-A(80AL)	Adult finger clip,2.8m		
	U401-B(80AL)	Adult silicone soft tip,2.8m			
	U401-C(80AL)	Pediatric finger clip,2.8m			
	U401-D(80AL)	Pediatric silicone soft tip,2.8m			
	U401-D(80AL-E)	Infant silicone soft tip,2.8m			
	U401-D(80AL-F)	Neonate silicone wrap,2.8m			
	U401-D(80AL-G)	Neonate "Y" type,2.8m			
	U401-A(80AL-H)	Adult ear clip,2.8m			
	SHANGHAI 3F (6 pin)				
	Diona Pms-8100I, RIS300/IRISS00, Phoebe PMS8300/8310, Phoebepropms8300/8310 pms8110A	U401-A(49AL)	Adult finger clip,2.8m		
U401-B(49AL)		Adult silicone soft tip,2.8m			
U401-C(49AL)		Pediatric finger clip,2.8m			
U401-D(49AL)		Pediatric silicone soft tip,2.8m			
U401-D(49AL-E)		Infant silicone soft tip,2.8m			
U401-D(49AL-F)		Neonate silicone wrap,2.8m			
U401-D(49AL-G)		Neonate "Y" type,2.8m			
U401-A(49AL-H)		Adult ear clip,2.8m			
Spring (6 pin 40°)					
9000A (Digital tech)		U401-A(148AL)	Adult finger clip,2.8m		
	U401-B(148AL)	Adult silicone soft tip,2.8m			
	U401-C(148AL)	Pediatric finger clip,2.8m			
	U401-D(148AL)	Pediatric silicone soft tip,2.8m			
	U401-D(148AL-E)	Infant silicone soft tip,2.8m			
	U401-D(148AL-F)	Neonate silicone wrap,2.8m			
	U401-D(148AL-G)	Neonate "Y" type,2.8m			
	U401-A(148AL-H)	Adult ear clip,2.8m			
	Tomorrow (5 pin)				
	TR-900E	U401-A(50AL)	Adult finger clip,2.8m		
U401-B(50AL)		Adult silicone soft tip,2.8m			
U401-C(50AL)		Pediatric finger clip,2.8m			
U401-D(50AL)		Pediatric silicone soft tip,2.8m			
U401-D(50AL-E)		Infant silicone soft tip,2.8m			
U401-D(50AL-F)		Neonate silicone wrap,2.8m			
U401-D(50AL-G)		Neonate "Y" type,2.8m			
U401-A(50AL-H)		Adult ear clip,2.8m			
Tomorrow (6 pin 40°)					
U401-A(50BL)		U401-A(50BL)	Adult finger clip,2.8m		
	U401-B(50BL)	Adult silicone soft tip,2.8m			
	U401-C(50BL)	Pediatric finger clip,2.8m			
	U401-D(50BL)	Pediatric silicone soft tip,2.8m			
	U401-D(50BL-E)	Infant silicone soft tip,2.8m			
	U401-D(50BL-F)	Neonate silicone wrap,2.8m			
	U401-D(50BL-G)	Neonate "Y" type,2.8m			
	U401-A(50BL-H)	Adult ear clip,2.8m			
	Tomorrow (6 pin)				
	TR-900J	U401-A(50CL)	Adult finger clip,2.8m		
U401-B(50CL)		Adult silicone soft tip,2.8m			
U401-C(50CL)		Pediatric finger clip,2.8m			
U401-D(50CL)		Pediatric silicone soft tip,2.8m			
U401-D(50CL-E)		Infant silicone soft tip,2.8m			
U401-D(50CL-F)		Neonate silicone wrap,2.8m			
U401-D(50CL-G)		Neonate "Y" type,2.8m			
U401-A(50CL-H)		Adult ear clip,2.8m			
Top (6 pin 40°)					
TOP 2000		U401-A(150AL)	Adult finger clip,2.8m		
	U401-B(150AL)	Adult silicone soft tip,2.8m			
	U401-C(150AL)	Pediatric finger clip,2.8m			
	U401-D(150AL)	Pediatric silicone soft tip,2.8m			
	U401-D(150AL-E)	Infant silicone soft tip,2.8m			
	U401-D(150AL-F)	Neonate silicone wrap,2.8m			
	U401-D(150AL-G)	Neonate "Y" type,2.8m			
	U401-A(150AL-H)	Adult ear clip,2.8m			

Brand/Compatible Models	P/N	Description	Male Connector		
Top (6 pin 40°)					
TOP 1800 (Digital tech)	U401-A(150BL)	Adult finger clip,2.8m			
	U401-B(150BL)	Adult silicone soft tip,2.8m			
	U401-C(150BL)	Pediatric finger clip,2.8m			
	U401-D(150BL)	Pediatric silicone soft tip,2.8m			
	U401-D(150BL-E)	Infant silicone soft tip,2.8m			
	U401-D(150BL-F)	Neonate silicone wrap,2.8m			
	U401-D(150BL-G)	Neonate "Y" type,2.8m			
	U401-A(150BL-H)	Adult ear clip,2.8m			
	Trismed (5 pin)				
	FM-8000 (Digital tech)	U401-A(166AL)		Adult finger clip,2.8m	
U401-B(166AL)		Adult silicone soft tip,2.8m			
U401-C(166AL)		Pediatric finger clip,2.8m			
U401-D(166AL)		Pediatric silicone soft tip,2.8m			
U401-D(166AL-E)		Infant silicone soft tip,2.8m			
U401-D(166AL-F)		Neonate silicone wrap,2.8m			
U401-D(166AL-G)		Neonate "Y" type,2.8m			
U401-A(166AL-H)		Adult ear clip,2.8m			
Trismed (5 pin)					
7000K (Digital tech)		U401-A(166BL)	Adult finger clip,2.8m		
	U401-B(166BL)	Adult silicone soft tip,2.8m			
	U401-C(166BL)	Pediatric finger clip,2.8m			
	U401-D(166BL)	Pediatric silicone soft tip,2.8m			
	U401-D(166BL-E)	Infant silicone soft tip,2.8m			
	U401-D(166BL-F)	Neonate silicone wrap,2.8m			
	U401-D(166BL-G)	Neonate "Y" type,2.8m			
	U401-A(166BL-H)	Adult ear clip,2.8m			
	Triton (9 pin)				
	U401-A(167AL)	U401-A(167AL)	Adult finger clip,2.8m		
U401-B(167AL)		Adult silicone soft tip,2.8m			
U401-C(167AL)		Pediatric finger clip,2.8m			
U401-D(167AL)		Pediatric silicone soft tip,2.8m			
U401-D(167AL-E)		Infant silicone soft tip,2.8m			
U401-D(167AL-F)		Neonate silicone wrap,2.8m			
U401-D(167AL-G)		Neonate "Y" type,2.8m			
U401-A(167AL-H)		Adult ear clip,2.8m			
USB					
U401-A(114AL)		U401-A(114AL)	Adult finger clip,2.8m		
	U401-B(114AL)	Adult silicone soft tip,2.8m			
	U401-C(114AL)	Pediatric finger clip,2.8m			
	U401-D(114AL)	Pediatric silicone soft tip,2.8m			
	U401-D(114AL-E)	Infant silicone soft tip,2.8m			
	U401-D(114AL-F)	Neonate silicone wrap,2.8m			
	U401-D(114AL-G)	Neonate "Y" type,2.8m			
	U401-A(114AL-H)	Adult ear clip,2.8m			
	Unicare (6 pin)				
	U401-A(58AL)	U401-A(58AL)	Adult finger clip,2.8m		
U401-B(58AL)		Adult silicone soft tip,2.8m			
U401-C(58AL)		Pediatric finger clip,2.8m			
U401-D(58AL)		Pediatric silicone soft tip,2.8m			
U401-D(58AL-E)		Infant silicone soft tip,2.8m			
U401-D(58AL-F)		Neonate silicone wrap,2.8m			
U401-D(58AL-G)		Neonate "Y" type,2.8m			
U401-A(58AL-H)		Adult ear clip,2.8m			
Unicare (5 pin)					
(Digital tech)		U401-A(58BL)	Adult finger clip,2.8m		
	U401-B(58BL)	Adult silicone soft tip,2.8m			
	U401-C(58BL)	Pediatric finger clip,2.8m			
	U401-D(58BL)	Pediatric silicone soft tip,2.8m			
	U401-D(58BL-E)	Infant silicone soft tip,2.8m			
	U401-D(58BL-F)	Neonate silicone wrap,2.8m			
	U401-D(58BL-G)	Neonate "Y" type,2.8m			
	U401-A(58BL-H)	Adult ear clip,2.8m			
	Unicare (6 pin)				
	(Digital Tech)	U401-A(58CL)	Adult finger clip,2.8m		
U401-B(58CL)		Adult silicone soft tip,2.8m			
U401-C(58CL)		Pediatric finger clip,2.8m			
U401-D(58CL)		Pediatric silicone soft tip,2.8m			
U401-D(58CL-E)		Infant silicone soft tip,2.8m			
U401-D(58CL-F)		Neonate silicone wrap,2.8m			
U401-D(58CL-G)		Neonate "Y" type,2.8m			
U401-A(58CL-H)		Adult ear clip,2.8m			
Unicare (12 pin)					
(Digital Tech)		U401-A(58DL)	Adult finger clip,2.8m		
	U401-B(58DL)	Adult silicone soft tip,2.8m			
	U401-C(58DL)	Pediatric finger clip,2.8m			
	U401-D(58DL)	Pediatric silicone soft tip,2.8m			
	U401-D(58DL-E)	Infant silicone soft tip,2.8m			
	U401-D(58DL-F)	Neonate silicone wrap,2.8m			
	U401-D(58DL-G)	Neonate "Y" type,2.8m			
	U401-A(58DL-H)	Adult ear clip,2.8m			

Brand/Compatible Models	P/N	Description	Male Connector		
Utech (6 pin)					
VS2000 (Digital Tech)	U401-A(168AL)	Adult finger clip,2.8m			
	U401-B(168AL)	Adult silicone soft tip,2.8m			
	U401-C(168AL)	Pediatric finger clip,2.8m			
	U401-D(168AL)	Pediatric silicone soft tip,2.8m			
	U401-D(168AL-E)	Infant silicone soft tip,2.8m			
	U401-D(168AL-F)	Neonate silicone wrap,2.8m			
	U401-D(168AL-G)	Neonate "Y" type,2.8m			
	U401-A(168AL-H)	Adult ear clip,2.8m			
	Weinmann (6 pin)				
	U401-A(66AL)	U401-A(66AL)		Adult finger clip,2.8m	
U401-B(66AL)		Adult silicone soft tip,2.8m			
U401-C(66AL)		Pediatric finger clip,2.8m			
U401-D(66AL)		Pediatric silicone soft tip,2.8m			
U401-D(66AL-E)		Infant silicone soft tip,2.8m			
U401-D(66AL-F)		Neonate silicone wrap,2.8m			
U401-D(66AL-G)		Neonate "Y" type,2.8m			
U401-A(66AL-H)		Adult ear clip,2.8m			
Weinmann (6 pin)					
U401-A(66AS)		U401-A(66AS)	Adult finger clip,0.9m		
	U401-B(66AS)	Adult silicone soft tip,0.9m			
	U401-C(66AS)	Pediatric finger clip,0.9m			
	U401-D(66AS)	Pediatric silicone soft tip,0.9m			
	U401-D(66AS-E)	Infant silicone soft tip,0.9m			
	U401-D(66AS-F)	Neonate silicone wrap,0.9m			
	U401-D(66AS-G)	Neonate "Y" type,0.9m			
	U401-A(66AS-H)	Adult ear clip,0.9m			
	Welch Allyn (7 pin)				
	U401-A(61AL)	U401-A(61AL)	Adult finger clip,2.8m		
U401-B(61AL)		Adult silicone soft tip,2.8m			
U401-C(61AL)		Pediatric finger clip,2.8m			
U401-D(61AL)		Pediatric silicone soft tip,2.8m			
U401-D(61AL-E)		Infant silicone soft tip,2.8m			
U401-D(61AL-F)		Neonate silicone wrap,2.8m			
U401-D(61AL-G)		Neonate "Y" type,2.8m			
U401-A(61AL-H)		Adult ear clip,2.8m			
Welch Allyn (7 pin)					
(Non-Oximax tech)		U401-A(61AS)	Adult finger clip,0.9m		
	U401-B(61AS)	Adult silicone soft tip,0.9m			
	U401-C(61AS)	Pediatric finger clip,0.9m			
	U401-D(61AS)	Pediatric silicone soft tip,0.9m			
	U401-D(61AS-E)	Infant silicone soft tip,0.9m			
	U401-D(61AS-F)	Neonate silicone wrap,0.9m			

Y~Z

Brand/Compatible Models	P/N	Description	Male Connector
Yonker (6 pin 40°)			
U401-A(154BL)	U401-A(154BL)	Adult finger clip,2.8m	
U401-B(154BL)	U401-B(154BL)	Adult silicone soft tip,2.8m	
U401-C(154BL)	U401-C(154BL)	Pediatric finger clip,2.8m	
U401-D(154BL)	U401-D(154BL)	Pediatric silicone soft tip,2.8m	
U401-D(154BL-E)	U401-D(154BL-E)	Infant silicone soft tip,2.8m	
U401-D(154BL-F)	U401-D(154BL-F)	Neonate silicone wrap,2.8m	
U401-D(154BL-G)	U401-D(154BL-G)	Neonate "Y" type,2.8m	
U401-A(154BL-H)	U401-A(154BL-H)	Adult ear clip,2.8m	
ZOLL (7 pin)			
U401-A(47AL)	U401-A(47AL)	Adult finger clip,2.8m	
U401-B(47AL)	U401-B(47AL)	Adult silicone soft tip,2.8m	
U401-C(47AL)	U401-C(47AL)	Pediatric finger clip,2.8m	
U401-D(47AL)	U401-D(47AL)	Pediatric silicone soft tip,2.8m	
U401-D(47AL-E)	U401-D(47AL-E)	Infant silicone soft tip,2.8m	
U401-D(47AL-F)	U401-D(47AL-F)	Neonate silicone wrap,2.8m	
U401-D(47AL-G)	U401-D(47AL-G)	Neonate "Y" type,2.8m	
U401-A(47AL-H)	U401-A(47AL-H)	Adult ear clip,2.8m	
(Masimo tech)			
U401-A(47AS)	U401-A(47AS)	Adult finger clip,0.9m	
U401-B(47AS)	U401-B(47AS)	Adult silicone soft tip,0.9m	
U401-C(47AS)	U401-C(47AS)	Pediatric finger clip,0.9m	
U401-D(47AS)	U401-D(47AS)	Pediatric silicone soft tip,0.9m	
U401-D(47AS-E)	U401-D(47AS-E)	Infant silicone soft tip,0.9m	
U401-D(47AS-F)	U401-D(47AS-F)	Neonate silicone wrap,0.9m	
U401-D(47AS-G)	U401-D(47AS-G)	Neonate "Y" type,0.9m	
U401-A(47AS-H)	U401-A(47AS-H)	Adult ear clip,0.9m	
ZOLL (14 pin)			
U401-A(47BL)	U401-A(47BL)	Adult finger clip,2.8m	
U401-B(47BL)	U401-B(47BL)	Adult silicone soft tip,2.8m	
U401-C(47BL)	U401-C(47BL)	Pediatric finger clip,2.8m	
U401-D(47BL)	U401-D(47BL)	Pediatric silicone soft tip,2.8m	
U401-D(47BL-E)	U401-D(47BL-E)	Infant silicone soft tip,2.8m	
U401-D(47BL-F)	U401-D(47BL-F)	Neonate silicone wrap,2.8m	
U401-D(47BL-G)	U401-D(47BL-G)	Neonate "Y" type,2.8m	
U401-A(47BL-H)	U401-A(47BL-H)	Adult ear clip,2.8m	
Zoncare (6 pin)			
U401-A(99AL)	U401-A(99AL)	Adult finger clip,2.8m	
U401-B(99AL)	U401-B(99AL)	Adult silicone soft tip,2.8m	
U401-C(99AL)	U401-C(99AL)	Pediatric finger clip,2.8m	
U401-D(99AL)	U401-D(99AL)	Pediatric silicone soft tip,2.8m	
U401-D(99AL-E)	U401-D(99AL-E)	Infant silicone soft tip,2.8m	
U401-D(99AL-F)	U401-D(99AL-F)	Neonate silicone wrap,2.8m	
U401-D(99AL-G)	U401-D(99AL-G)	Neonate "Y" type,2.8m	
U401-A(99AL-H)	U401-A(99AL-H)	Adult ear clip,2.8m	
Zoncare (6 pin)			
U401-A(99BL)	U401-A(99BL)	Adult finger clip,2.8m	
U401-B(99BL)	U401-B(99BL)	Adult silicone soft tip,2.8m	
U401-C(99BL)	U401-C(99BL)	Pediatric finger clip,2.8m	
U401-D(99BL)	U401-D(99BL)	Pediatric silicone soft tip,2.8m	
U401-D(99BL-E)	U401-D(99BL-E)	Infant silicone soft tip,2.8m	
U401-D(99BL-F)	U401-D(99BL-F)	Neonate silicone wrap,2.8m	
U401-D(99BL-G)	U401-D(99BL-G)	Neonate "Y" type,2.8m	
U401-A(99BL-H)	U401-A(99BL-H)	Adult ear clip,2.8m	
(Digital tech)			

Brand/Compatible Models	P/N	Description	Male Connector
Zoncare (6 pin 40°)			
(Digital tech)	U401-A(99CL)	Adult finger clip,2.8m	
	U401-B(99CL)	Adult silicone soft tip,2.8m	
	U401-C(99CL)	Pediatric finger clip,2.8m	
	U401-D(99CL)	Pediatric silicone soft tip,2.8m	
	U401-D(99CL-E)	Infant silicone soft tip,2.8m	
	U401-D(99CL-F)	Neonate silicone wrap,2.8m	
	U401-D(99CL-G)	Neonate "Y" type,2.8m	
	U401-A(99CL-H)	Adult ear clip,2.8m	
Zondon (6 pin)			
(Masimo tech)	U401-A(55AL)	Adult finger clip,2.8m	
	U401-B(55AL)	Adult silicone soft tip,2.8m	
	U401-C(55AL)	Pediatric finger clip,2.8m	
	U401-D(55AL)	Pediatric silicone soft tip,2.8m	
	U401-D(55AL-E)	Infant silicone soft tip,2.8m	
	U401-D(55AL-F)	Neonate silicone wrap,2.8m	
	U401-D(55AL-G)	Neonate "Y" type,2.8m	
	U401-A(55AL-H)	Adult ear clip,2.8m	
Zondon (8 pin 40°)			
Apollo N1 (Masimo tech)	U401-A(55BL)	Adult finger clip,2.8m	
	U401-B(55BL)	Adult silicone soft tip,2.8m	
	U401-C(55BL)	Pediatric finger clip,2.8m	
	U401-D(55BL)	Pediatric silicone soft tip,2.8m	
	U401-D(55BL-E)	Infant silicone soft tip,2.8m	
	U401-D(55BL-F)	Neonate silicone wrap,2.8m	
	U401-D(55BL-G)	Neonate "Y" type,2.8m	
	U401-A(55BL-H)	Adult ear clip,2.8m	
Zondon (14 pin)			
Zondon (Masimo + Oximax tech)	U401-A(55CL)	Adult finger clip,2.8m	
	U401-B(55CL)	Adult silicone soft tip,2.8m	
	U401-C(55CL)	Pediatric finger clip,2.8m	
	U401-D(55CL)	Pediatric silicone soft tip,2.8m	
	U401-D(55CL-E)	Infant silicone soft tip,2.8m	
	U401-D(55CL-F)	Neonate silicone wrap,2.8m	
	U401-D(55CL-G)	Neonate "Y" type,2.8m	
	U401-A(55CL-H)	Adult ear clip,2.8m	
Zondon (6 pin)			
Zondon (Digital tech)	U401-A(55DL)	Adult finger clip,2.8m	
	U401-B(55DL)	Adult silicone soft tip,2.8m	
	U401-C(55DL)	Pediatric finger clip,2.8m	
	U401-D(55DL)	Pediatric silicone soft tip,2.8m	
	U401-D(55DL-E)	Infant silicone soft tip,2.8m	
	U401-D(55DL-F)	Neonate silicone wrap,2.8m	
	U401-D(55DL-G)	Neonate "Y" type,2.8m	
	U401-A(55DL-H)	Adult ear clip,2.8m	
Zondon (8 pin)			
Apollo N3 (Masimo tech)	U401-A(55EL)	Adult finger clip,2.8m	
	U401-B(55EL)	Adult silicone soft tip,2.8m	
	U401-C(55EL)	Pediatric finger clip,2.8m	
	U401-D(55EL)	Pediatric silicone soft tip,2.8m	
	U401-D(55EL-E)	Infant silicone soft tip,2.8m	
	U401-D(55EL-F)	Neonate silicone wrap,2.8m	
	U401-D(55EL-G)	Neonate "Y" type,2.8m	
	U401-A(55EL-H)	Adult ear clip,2.8m	





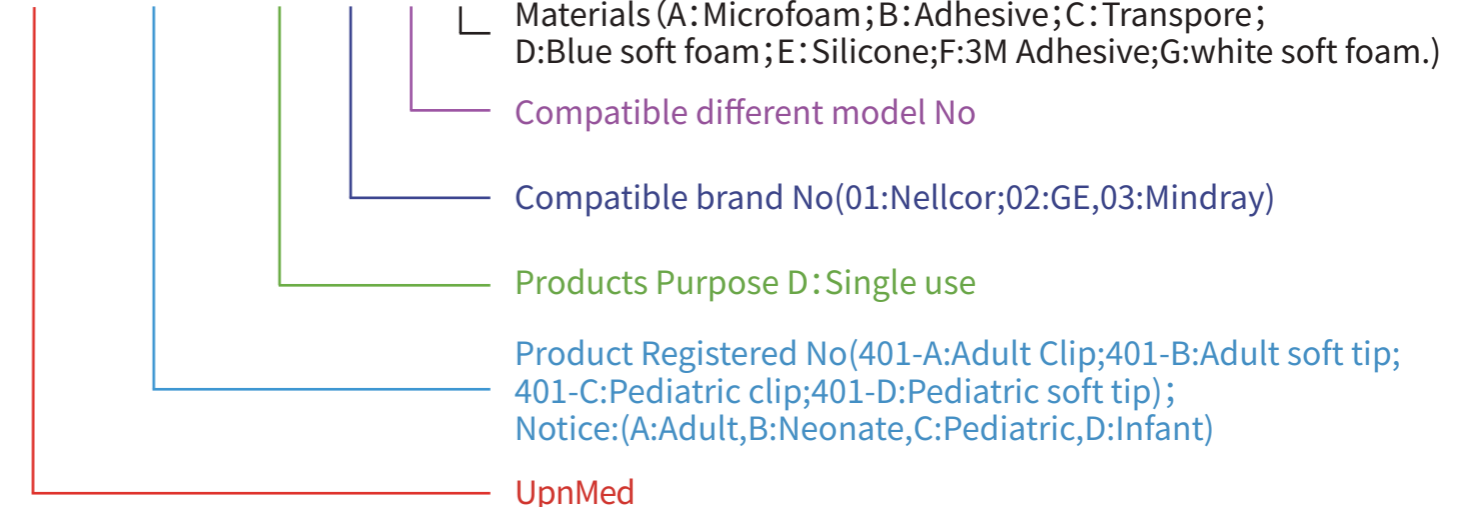

Disposable / Single use SpO₂ Sensor





U401-B(D02AB)







For example: U401-A(D01AA): Nellcor Disposable Adult SpO₂ sensor, Microfoam type.
 U401-B (D02AB) :GE Disposable Neonate SpO₂ sensor, Adhesive type.

Brand/Compatible Models	P/N	Size	Materials	Cable Length	Image
B~C Biolight A Series, M Series - Digital tech	U401-A(D09BA)	Adult	Micro foam	0.9m	
	U401-B(D09BA)	Neonate/Adult	Micro foam	0.9m	
	U401-C(D09BA)	Pediatric	Micro foam	0.9m	
	U401-D(D09BA)	Infant	Micro foam	0.9m	
	U401-A(D09BB)	Adult	Adhesive	0.9m	
	U401-B(D09BB)	Neonate/Adult	Adhesive	0.9m	
	U401-C(D09BB)	Pediatric	Adhesive	0.9m	
	U401-D(D09BB)	Infant	Adhesive	0.9m	
	U401-A(D09BC)	Adult	Transpore	0.9m	
	U401-C(D09BC)	Pediatric	Transpore	0.9m	
	U401-A(D09BD)	Neonate/Adult	Blue soft foam	0.9m	
	U401-C(D09BD)	Pediatric	Blue soft foam	0.9m	
BCI	U401-A(D22AA)	Adult	Micro foam	0.9m	
	U401-B(D22AA)	Neonate/Adult	Micro foam	0.9m	
	U401-C(D22AA)	Pediatric	Micro foam	0.9m	
	U401-D(D22AA)	Infant	Micro foam	0.9m	
	U401-A(D22AB)	Adult	Adhesive	0.9m	
	U401-B(D22AB)	Neonate/Adult	Adhesive	0.9m	
	U401-C(D22AB)	Pediatric	Adhesive	0.9m	
	U401-D(D22AB)	Infant	Adhesive	0.9m	
	U401-A(D22AC)	Adult	Transpore	0.9m	
	U401-C(D22AC)	Pediatric	Transpore	0.9m	
	U401-A(D22AD)	Neonate/Adult	Blue soft foam	0.9m	
	U401-C(D22AD)	Pediatric	Blue soft foam	0.9m	
Contec - Digital tech	U401-A(D48BA)	Adult	Micro foam	0.9m	
	U401-B(D48BA)	Neonate/Adult	Micro foam	0.9m	
	U401-C(D48BA)	Pediatric	Micro foam	0.9m	
	U401-D(D48BA)	Infant	Micro foam	0.9m	
	U401-A(D48BB)	Adult	Adhesive	0.9m	
	U401-B(D48BB)	Neonate/Adult	Adhesive	0.9m	
	U401-C(D48BB)	Pediatric	Adhesive	0.9m	
	U401-D(D48BB)	Infant	Adhesive	0.9m	
	U401-A(D48BC)	Adult	Transpore	0.9m	
	U401-C(D48BC)	Pediatric	Transpore	0.9m	
	U401-A(D48BD)	Neonate/Adult	Blue soft foam	0.9m	
	U401-C(D48BD)	Pediatric	Blue soft foam	0.9m	
Creative - Digital tech	U401-A(D10BA)	Adult	Micro foam	0.9m	
	U401-B(D10BA)	Neonate/Adult	Micro foam	0.9m	
	U401-C(D10BA)	Pediatric	Micro foam	0.9m	
	U401-D(D10BA)	Infant	Micro foam	0.9m	
	U401-A(D10BB)	Adult	Adhesive	0.9m	
	U401-B(D10BB)	Neonate/Adult	Adhesive	0.9m	
	U401-C(D10BB)	Pediatric	Adhesive	0.9m	
	U401-D(D10BB)	Infant	Adhesive	0.9m	
	U401-A(D10BC)	Adult	Transpore	0.9m	
	U401-C(D10BC)	Pediatric	Transpore	0.9m	
	U401-A(D10BD)	Neonate/Adult	Blue soft foam	0.9m	
	U401-C(D10BD)	Pediatric	Blue soft foam	0.9m	

Brand/Compatible Models	P/N	Size	Materials	Cable Length	Image
C~D CSI	U401-A(D12AA)	Adult	Micro foam	0.9m	
	U401-B(D12AA)	Neonate/Adult	Micro foam	0.9m	
	U401-C(D12AA)	Pediatric	Micro foam	0.9m	
	U401-D(D12AA)	Infant	Micro foam	0.9m	
	U401-A(D12AB)	Adult	Adhesive	0.9m	
	U401-B(D12AB)	Neonate/Adult	Adhesive	0.9m	
	U401-C(D12AB)	Pediatric	Adhesive	0.9m	
	U401-D(D12AB)	Infant	Adhesive	0.9m	
	U401-A(D12AC)	Adult	Transpore	0.9m	
	U401-C(D12AC)	Pediatric	Transpore	0.9m	
	U401-A(D12AD)	Neonate/Adult	Blue soft foam	0.9m	
	U401-C(D12AD)	Pediatric	Blue soft foam	0.9m	
Datascope	U401-A(D14AA)	Adult	Micro foam	0.9m	
	U401-B(D14AA)	Neonate/Adult	Micro foam	0.9m	
	U401-C(D14AA)	Pediatric	Micro foam	0.9m	
	U401-D(D14AA)	Infant	Micro foam	0.9m	
	U401-A(D14AB)	Adult	Adhesive	0.9m	
	U401-B(D14AB)	Neonate/Adult	Adhesive	0.9m	
	U401-C(D14AB)	Pediatric	Adhesive	0.9m	
	U401-D(D14AB)	Infant	Adhesive	0.9m	
	U401-A(D14AC)	Adult	Transpore	0.9m	
	U401-C(D14AC)	Pediatric	Transpore	0.9m	
	U401-A(D14AD)	Neonate/Adult	Blue soft foam	0.9m	
	U401-C(D14AD)	Pediatric	Blue soft foam	0.9m	
Dolphin	U401-A(D26AA)	Adult	Micro foam	0.9m	
	U401-B(D26AA)	Neonate/Adult	Micro foam	0.9m	
	U401-C(D26AA)	Pediatric	Micro foam	0.9m	
	U401-D(D26AA)	Infant	Micro foam	0.9m	
	U401-A(D26AB)	Adult	Adhesive	0.9m	
	U401-B(D26AB)	Neonate/Adult	Adhesive	0.9m	
	U401-C(D26AB)	Pediatric	Adhesive	0.9m	
	U401-D(D26AB)	Infant	Adhesive	0.9m	
	U401-A(D26AC)	Adult	Transpore	0.9m	
	U401-C(D26AC)	Pediatric	Transpore	0.9m	
	U401-A(D26AD)	Neonate/Adult	Blue soft foam	0.9m	
	U401-C(D26AD)	Pediatric	Blue soft foam	0.9m	
GE Datex Ohmeda - Oxitip	U401-A(D06AA)	Adult	Micro foam	0.9m	
	U401-B(D06AA)	Neonate/Adult	Micro foam	0.9m	
	U401-C(D06AA)	Pediatric	Micro foam	0.9m	
	U401-D(D06AA)	Infant	Micro foam	0.9m	
	U401-A(D06AB)	Adult	Adhesive	0.9m	
	U401-B(D06AB)	Neonate/Adult	Adhesive	0.9m	
	U401-C(D06AB)	Pediatric	Adhesive	0.9m	
	U401-D(D06AB)	Infant	Adhesive	0.9m	
	U401-A(D06AC)	Adult	Transpore	0.9m	
	U401-C(D06AC)	Pediatric	Transpore	0.9m	
	U401-A(D06AD)	Neonate/Adult	Blue soft foam	0.9m	
	U401-C(D06AD)	Pediatric	Blue soft foam	0.9m	

Brand/Compatible Models	P/N	Size	Materials	Cable Length	Image
GE Datex Ohmeda G~M	U401-A(D06BA)	Adult	Micro foam	0.9m	
	U401-B(D06BA)	Neonate/Adult	Micro foam	0.9m	
	U401-C(D06BA)	Pediatric	Micro foam	0.9m	
	U401-D(D06BA)	Infant	Micro foam	0.9m	
	U401-A(D06BB)	Adult	Adhesive	0.9m	
	U401-B(D06BB)	Neonate/Adult	Adhesive	0.9m	
	U401-C(D06BB)	Pediatric	Adhesive	0.9m	
	U401-D(D06BB)	Infant	Adhesive	0.9m	
	U401-A(D06BC)	Adult	Transpore	0.9m	
	U401-C(D06BC)	Pediatric	Transpore	0.9m	
	U401-A(D06BD)	Neonate/Adult	Blue soft foam	0.9m	
	U401-C(D06BD)	Pediatric	Blue soft foam	0.9m	
GE Datex Ohmeda - TruSignal	U401-A(D02BA)	Adult	Micro foam	0.9m	
	U401-B(D02BA)	Neonate/Adult	Micro foam	0.9m	
	U401-C(D02BA)	Pediatric	Micro foam	0.9m	
	U401-D(D02BA)	Infant	Micro foam	0.9m	
	U401-A(D02BB)	Adult	Adhesive	0.9m	
	U401-B(D02BB)	Neonate/Adult	Adhesive	0.9m	
	U401-C(D02BB)	Pediatric	Adhesive	0.9m	
	U401-D(D02BB)	Infant	Adhesive	0.9m	
	U401-A(D02BC)	Adult	Transpore	0.9m	
	U401-C(D02BC)	Pediatric	Transpore	0.9m	
	U401-A(D02BD)	Neonate/Adult	Blue soft foam	0.9m	
	U401-C(D02BD)	Pediatric	Blue soft foam	0.9m	
Masimo - LNCP 6 pin	U401-A(D19AA)	Adult	Micro foam	0.9m	
	U401-B(D19AA)	Neonate/Adult	Micro foam	0.9m	
	U401-C(D19AA)	Pediatric	Micro foam	0.9m	
	U401-D(D19AA)	Infant	Micro foam	0.9m	
	U401-A(D19AB)	Adult	Adhesive	0.9m	
	U401-B(D19AB)	Neonate/Adult	Adhesive	0.9m	
	U401-C(D19AB)	Pediatric	Adhesive	0.9m	
	U401-D(D19AB)	Infant	Adhesive	0.9m	
	U401-A(D19AC)	Adult	Transpore	0.9m	
	U401-C(D19AC)	Pediatric	Transpore	0.9m	
	U401-A(D19AD)	Neonate/Adult	Blue soft foam	0.9m	
	U401-C(D19AD)	Pediatric	Blue soft foam	0.9m	
Masimo - LNCS 7 pin	U401-A(D19BA)	Adult	Micro foam	0.9m	
	U401-B(D19BA)	Neonate/Adult	Micro foam	0.9m	
	U401-C(D19BA)	Pediatric	Micro foam	0.9m	
	U401-D(D19BA)	Infant	Micro foam	0.9m	
	U401-A(D19BB)	Adult	Adhesive	0.9m	
	U401-B(D19BB)	Neonate/Adult	Adhesive	0.9m	
	U401-C(D19BB)	Pediatric	Adhesive	0.9m	
	U401-D(D19BB)	Infant	Adhesive	0.9m	
	U401-A(D19BC)	Adult	Transpore	0.9m	
	U401-C(D19BC)	Pediatric	Transpore	0.9m	
	U401-A(D19BD)	Neonate/Adult	Blue soft foam	0.9m	
	U401-C(D19BD)	Pediatric	Blue soft foam	0.9m	

Brand/Compatible Models	P/N	Size	Materials	Cable Length	Image
Masimo - LNCS 9 pin	U401-A(D19CA)	Adult	Micro foam	0.9m	
	U401-B(D19CA)	Neonate/Adult	Micro foam	0.9m	
	U401-C(D19CA)	Pediatric	Micro foam	0.9m	
	U401-D(D19CA)	Infant	Micro foam	0.9m	
	U401-A(D19CB)	Adult	Adhesive	0.9m	
	U401-B(D19CB)	Neonate/Adult	Adhesive	0.9m	
	U401-C(D19CB)	Pediatric	Adhesive	0.9m	
	U401-D(D19CB)	Infant	Adhesive	0.9m	
	U401-A(D19CC)	Adult	Transpore	0.9m	
	U401-C(D19CC)	Pediatric	Transpore	0.9m	
	U401-A(D19CD)	Neonate/Adult	Blue soft foam	0.9m	
	U401-C(D19CD)	Pediatric	Blue soft foam	0.9m	
Masimo - LNCP 8 pin	U401-A(D19DA)	Adult	Micro foam	0.9m	
	U401-B(D19DA)	Neonate/Adult	Micro foam	0.9m	
	U401-C(D19DA)	Pediatric	Micro foam	0.9m	
	U401-D(D19DA)	Infant	Micro foam	0.9m	
	U401-A(D19DB)	Adult	Adhesive	0.9m	
	U401-B(D19DB)	Neonate/Adult	Adhesive	0.9m	
	U401-C(D19DB)	Pediatric	Adhesive	0.9m	
	U401-D(D19DB)	Infant	Adhesive	0.9m	
	U401-A(D19DC)	Adult	Transpore	0.9m	
	U401-C(D19DC)	Pediatric	Transpore	0.9m	
	U401-A(D19DD)	Neonate/Adult	Blue soft foam	0.9m	
	U401-C(D19DD)	Pediatric	Blue soft foam	0.9m	
Masimo - LNCS 15-11 pin	U401-A(D19EA)	Adult	Micro foam	0.9m	
	U401-B(D19EA)	Neonate/Adult	Micro foam	0.9m	
	U401-C(D19EA)	Pediatric	Micro foam	0.9m	
	U401-D(D19EA)	Infant	Micro foam	0.9m	
	U401-A(D19EB)	Adult	Adhesive	0.9m	
	U401-B(D19EB)	Neonate/Adult	Adhesive	0.9m	
	U401-C(D19EB)	Pediatric	Adhesive	0.9m	
	U401-D(D19EB)	Infant	Adhesive	0.9m	
	U401-A(D19EC)	Adult	Transpore	0.9m	
	U401-C(D19EC)	Pediatric	Transpore	0.9m	
	U401-A(D19ED)	Neonate/Adult	Blue soft foam	0.9m	
	U401-C(D19ED)	Pediatric	Blue soft foam	0.9m	
Masimo - LNCS 15-11 pin (NEW chips)	U401-A(D19JA)	Adult	Micro foam	0.9m	
	U401-B(D19JA)	Neonate/Adult	Micro foam	0.9m	
	U401-C(D19JA)	Pediatric	Micro foam	0.9m	
	U401-D(D19JA)	Infant	Micro foam	0.9m	
	U401-A(D19JB)	Adult	Adhesive	0.9m	
	U401-B(D19JB)	Neonate/Adult	Adhesive	0.9m	
	U401-C(D19JB)	Pediatric	Adhesive	0.9m	
	U401-D(D19JB)	Infant	Adhesive	0.9m	
	U401-A(D19JC)	Adult	Transpore	0.9m	
	U401-C(D19JC)	Pediatric	Transpore	0.9m	
	U401-A(D19JD)	Neonate/Adult	Blue soft foam	0.9m	
	U401-C(D19JD)	Pediatric	Blue soft foam	0.9m	

G~M

M~M

Brand/Compatible Models	P/N	Size	Materials	Cable Length	Image
MEK	U401-A(D13AA)	Adult	Micro foam	0.9m	
	U401-B(D13AA)	Neonate/Adult	Micro foam	0.9m	
	U401-C(D13AA)	Pediatric	Micro foam	0.9m	
	U401-D(D13AA)	Infant	Micro foam	0.9m	
	U401-A(D13AB)	Adult	Adhesive	0.9m	
	U401-B(D13AB)	Neonate/Adult	Adhesive	0.9m	
	U401-C(D13AB)	Pediatric	Adhesive	0.9m	
	U401-D(D13AB)	Infant	Adhesive	0.9m	
	U401-A(D13AC)	Adult	Transpore	0.9m	
	U401-C(D13AC)	Pediatric	Transpore	0.9m	
	U401-A(D13AD)	Neonate/Adult	Blue soft foam	0.9m	
	U401-C(D13AD)	Pediatric	Blue soft foam	0.9m	
Nonin	U401-A(D21AA)	Adult	Micro foam	0.9m	
	U401-B(D21AA)	Neonate/Adult	Micro foam	0.9m	
	U401-C(D21AA)	Pediatric	Micro foam	0.9m	
	U401-D(D21AA)	Infant	Micro foam	0.9m	
	U401-A(D21AB)	Adult	Adhesive	0.9m	
	U401-B(D21AB)	Neonate/Adult	Adhesive	0.9m	
	U401-C(D21AB)	Pediatric	Adhesive	0.9m	
	U401-D(D21AB)	Infant	Adhesive	0.9m	
	U401-A(D21AC)	Adult	Transpore	0.9m	
	U401-C(D21AC)	Pediatric	Transpore	0.9m	
	U401-A(D21AD)	Neonate/Adult	Blue soft foam	0.9m	
	U401-C(D21AD)	Pediatric	Blue soft foam	0.9m	
Nihon Kohden	U401-A(D05AA)	Adult	Micro foam	0.9m	
	U401-B(D05AA)	Neonate/Adult	Micro foam	0.9m	
	U401-C(D05AA)	Pediatric	Micro foam	0.9m	
	U401-D(D05AA)	Infant	Micro foam	0.9m	
	U401-A(D05AB)	Adult	Adhesive	0.9m	
	U401-B(D05AB)	Neonate/Adult	Adhesive	0.9m	
	U401-C(D05AB)	Pediatric	Adhesive	0.9m	
	U401-D(D05AB)	Infant	Adhesive	0.9m	
	U401-A(D05AC)	Adult	Transpore	0.9m	
	U401-C(D05AC)	Pediatric	Transpore	0.9m	
	U401-A(D05AD)	Neonate/Adult	Blue soft foam	0.9m	
	U401-C(D05AD)	Pediatric	Blue soft foam	0.9m	
Novamatrix	U401-A(D16AA)	Adult	Micro foam	0.9m	
	U401-B(D16AA)	Neonate/Adult	Micro foam	0.9m	
	U401-C(D16AA)	Pediatric	Micro foam	0.9m	
	U401-D(D16AA)	Infant	Micro foam	0.9m	
	U401-A(D16AB)	Adult	Adhesive	0.9m	
	U401-B(D16AB)	Neonate/Adult	Adhesive	0.9m	
	U401-C(D16AB)	Pediatric	Adhesive	0.9m	
	U401-D(D16AB)	Infant	Adhesive	0.9m	
	U401-A(D16AC)	Adult	Transpore	0.9m	
	U401-C(D16AC)	Pediatric	Transpore	0.9m	
	U401-A(D16AD)	Neonate/Adult	Blue soft foam	0.9m	
	U401-C(D16AD)	Pediatric	Blue soft foam	0.9m	

Brand/Compatible Models	P/N	Size	Materials	Cable Length	Image
Nellcor - Non-oximax (All monitors which requires Nellcor Non-oximax technical)	U401-A(D01AA)	Adult	Micro foam	0.9m	
	U401-B(D01AA)	Neonate/Adult	Micro foam	0.9m	
	U401-C(D01AA)	Pediatric	Micro foam	0.9m	
	U401-D(D01AA)	Infant	Micro foam	0.9m	
	U401-A(D01AB)	Adult	Adhesive	0.9m	
	U401-B(D01AB)	Neonate/Adult	Adhesive	0.9m	
	U401-C(D01AB)	Pediatric	Adhesive	0.9m	
	U401-D(D01AB)	Infant	Adhesive	0.9m	
	U401-A(D01AC)	Adult	Transpore	0.9m	
	U401-C(D01AC)	Pediatric	Transpore	0.9m	
	U401-A(D01AD)	Neonate/Adult	Blue soft foam	0.9m	
	U401-C(D01AD)	Pediatric	Blue soft foam	0.9m	
Nellcor - OxiMax	U401-A(D01BA)	Adult	Micro foam	0.9m	
	U401-B(D01BA)	Neonate/Adult	Micro foam	0.9m	
	U401-C(D01BA)	Pediatric	Micro foam	0.9m	
	U401-D(D01BA)	Infant	Micro foam	0.9m	
	U401-A(D01BB)	Adult	Adhesive	0.9m	
	U401-B(D01BB)	Neonate/Adult	Adhesive	0.9m	
	U401-C(D01BB)	Pediatric	Adhesive	0.9m	
	U401-D(D01BB)	Infant	Adhesive	0.9m	
	U401-A(D01BC)	Adult	Transpore	0.9m	
	U401-C(D01BC)	Pediatric	Transpore	0.9m	
	U401-A(D01BD)	Neonate/Adult	Blue soft foam	0.9m	
	U401-C(D01BD)	Pediatric	Blue soft foam	0.9m	
Newtech - Digital tech	U401-A(D40AA)	Adult	Micro foam	0.9m	
	U401-B(D40AA)	Neonate/Adult	Micro foam	0.9m	
	U401-C(D40AA)	Pediatric	Micro foam	0.9m	
	U401-D(D40AA)	Infant	Micro foam	0.9m	
	U401-A(D40AB)	Adult	Adhesive	0.9m	
	U401-B(D40AB)	Neonate/Adult	Adhesive	0.9m	
	U401-C(D40AB)	Pediatric	Adhesive	0.9m	
	U401-D(D40AB)	Infant	Adhesive	0.9m	
	U401-A(D40AC)	Adult	Transpore	0.9m	
	U401-C(D40AC)	Pediatric	Transpore	0.9m	
	U401-A(D40AD)	Neonate/Adult	Blue soft foam	0.9m	
	U401-C(D40AD)	Pediatric	Blue soft foam	0.9m	
NORMAL - Digital tech	U401-A(D01EA)	Adult	Micro foam	0.9m	
	U401-B(D01EA)	Neonate/Adult	Micro foam	0.9m	
	U401-C(D01EA)	Pediatric	Micro foam	0.9m	
	U401-D(D01EA)	Infant	Micro foam	0.9m	
	U401-A(D01EB)	Adult	Adhesive	0.9m	
	U401-B(D01EB)	Neonate/Adult	Adhesive	0.9m	
	U401-C(D01EB)	Pediatric	Adhesive	0.9m	
	U401-D(D01EB)	Infant	Adhesive	0.9m	
	U401-A(D01EC)	Adult	Transpore	0.9m	
	U401-C(D01EC)	Pediatric	Transpore	0.9m	
	U401-A(D01ED)	Neonate/Adult	Blue soft foam	0.9m	
	U401-C(D01ED)	Pediatric	Blue soft foam	0.9m	

M~N

N~N



SpO₂ Adapter Cable

U701-1AS

L: Long wire 2.4m
S: Short wire 1.2m
G: Original

A: Female connector type (e.g A: DB9F C: LNOP)

1: Compatible model No

01: Compatible brand No (eg Nellcor: 01.GE:02)

7: SpO₂ adapter cable No

UpnMed

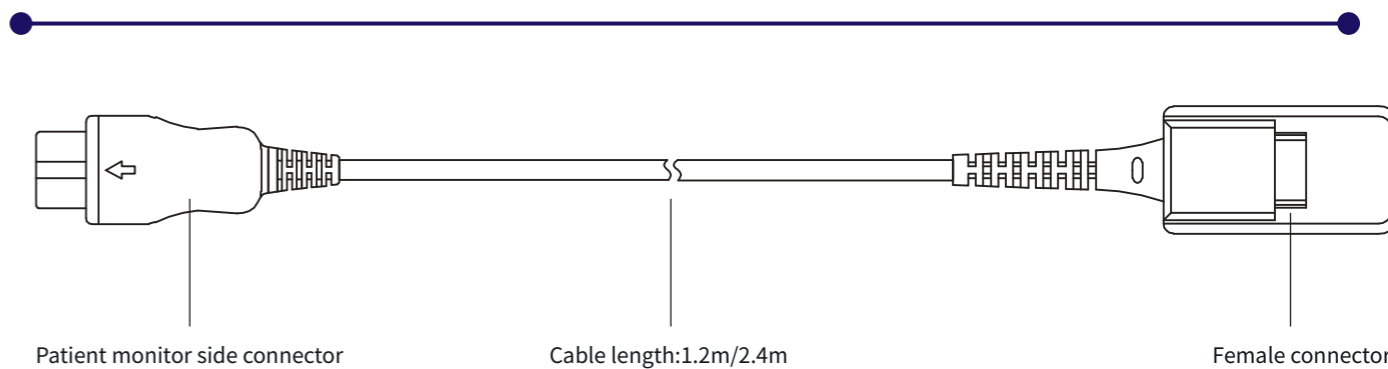

MALE CONNECTOR



FEMALE CONNECTOR

A	Nellcor 9P female connector		B	Nellcor 9P female connector		C	Masimo 6P LNOP female connector	
D	GE Trusignal 9P female connector		E	Philips 8P female connector		F	Ohmeda 8P female connector	
G	Nihon Kohden 9P female connector		H	Nellcor 9P Oximax female connector		J	Masimo 15P LNCS female connector	

Hot product display



B~B

Brand	Compatible Models	P/N	Description	Male Connector	Female Connector
BCI	BCI:3180, 3300, 3301, 3404, 6100, 9100,Advisor, Autocorr, Mini Torr, Mini Torr Plus; Larsen & Toubro Limited (L&T Medical) Stellar P,Star 50, Galaxy, Planet, Planet 50, Cosmic	U722-1AL	7 pin-DB9F, 2.4m fit for BCI sensor		
	BCI: 3304, 3303, 3302, 3301, 3300, 3400, 3401, 3403, 9200; Spacelabs Burdick: PRO2; Draeger: Oxipac 2000; Choice: MD300A	U722-2AL	9 pin-DB9F, 2.4m fit for BCI sensor		
Biolight	M6/M12	U709-2AL	5 pin-DB9F, 2.4m fit for Nellcor sensor		
	M69,BTD-352A (Digital Tech)	U709-3AL	5 pin-DB9F, 2.4m fit for Digital sensor		
		U709-4AL	6 pin-DB9F, 2.4m fit for Nellcor sensor		
	Biolight Digital Monitor: A3,A5,A6,A8 (Digital Tech)	U709-8AL	9 pin-DB9F, 2.4m fit for Digital sensor		
	Biolight Digital Monitor:M7000, M8000,M9000,M9500 (Digital Tech)	U709-9AL	12 pin-DB9F, 2.4m fit for Digital sensor		
Bionet	BM3,BM3 Plus	U723-1AL	6 pin-DB9F, 2.4m fit for Nellcor sensor		
	BM5	U723-2AL	7 pin-DB9F, 2.4m fit for Nellcor sensor		
	BM3VET/BM31	U723-3AL	7 pin-DB9F, 2.4m fit for Nellcor sensor		

B~C

Brand	Compatible Models	P/N	Description	Male Connector	Female Connector
Biocare	Im7,Im8,Im12,Im15 (Digital tech)	U746-1AL	5 pin-DB9F, 2.4m fit for Digital sensor		
	PM900,PM900S,PM2000	U746-2AL	6 pin-DB9F, 2.4m fit for Nellcor sensor		
		U746-3AL	6 pin 40°-DB9F, 2.4m fit for Nellcor sensor		
	IM12	U746-4AL	10 pin-DB9F, 2.4m fit for Nellcor sensor		
Biosys	Biosys BPM300 and MEK MP 7000	U743-1AL	6 pin-DB9F, 2.4m fit for Nellcor sensor		
Bruker	DC-3002,IH,M3	U724-1AL	12 pin-DB9F, 2.4m fit for Nellcor sensor		
Criticare / CSI	CSI:501,503,504,507,508,581 Scholar,Poet 602-3A,1100,1100-3 AMI:7500 Bird:4400 Mindray:503,507,508,509 Vitalog:all	U712-1AL	5 pin-DB9F, 2.4m fit for CSI sensor		
	CSI:503Spot/503DX/504DX/506DX/507ELC/2/SCHOLARIII/8100 poet Plus,Scholar Alaris:Vital Cheak 4400	U712-2AL	6 pin-DB9F, 2.4m fit for CSI sensor		
Comen	Start8000A/8000B/8000C/8000D/8000H;/Start-5000B/5000C;C50 (Digital tech)	U738-1AL	6 pin-DB9F, 2.4m fit for Digital sensor		
	Start-8000E	U738-2AL	6 pin-DB9F, 2.4m fit for Nellcor sensor		

C~C

Brand	Compatible Models	P/N	Description	Male Connector	Female Connector
Comen	C30,C90 (Mindray/Nellcor tech)	U738-3AL	7 pin-DB9F, 2.4m fit for Nellcor sensor		
	C30,C90 (Masimo tech)	U738-4BL	7 pin-DB9F, 2.4m fit for Masimo sensor		
		U738-4CL	7 pin-6J, 2.4m fit for Masimo sensor		
	C60,C80 (Oximax tech)	U738-5HL	8 pin-DB9F, 2.4m fit for Oximax sensor		
	C60,C80 (Oximax tech)	U738-6HL	8 pin 40°-DB9F, 2.4m fit for Oximax sensor		
	C60 (Masimo + Oximax tech)	U738-10BL	8 pin 40°-DB9F, 2.4m fit for Masimo+Oximax sensor		
	C30, C50 (Digital Tech)	U738-7AL	12 pin-DB9F, 2.4m fit for Digital sensor		
	C30 (Masimo + Oximax tech)	U738-9BL	12 pin-DB9F, 2.4m fit for Masimo+Oximax sensor		
		U738-9CL	12 pin-8J, 2.4m fit for Masimo+Oximax sensor		
		U738-9JL	12 pin-DB15F, 2.4m fit for Masimo+Oximax sensor		

C~C

Brand	Compatible Models	P/N	Description	Male Connector	Female Connector	
Comen	NC8A (Analog)	U738-11AL	12 pin-DB9F, 2.4m fit for Nellcor sensor			
	(Digital tech)	U748-1AL	5 pin-DB9F, 2.4m fit for Digital sensor			
Contec	CMS9000,SMS8000	U748-3AL	6 pin 40°-DB9F, 2.4m fit for Nellcor sensor			
		U770-1AL	5 pin-DB9F, 2.4m fit for Digital sensor			
Choice	(Digital tech)	U770-2AL	6 pin-DB9F, 2.4m fit for Nellcor sensor			
		U770-7AL	6 pin 40°-DB9F, 2.4m fit for Digital sensor			
	(Oximax tech)	U770-5HL	9 pin-DB9F, 2.4m fit for Oximax sensor			
		U770-6AL	9 pin-DB9F, 2.4m fit for BCI sensor			
	Corpuls	(Masimo tech)	U783-2BL	11 pin-DB9F, 2.4m fit for Masimo sensor		
			U783-2CL	11 pin-6J, 2.4m fit for Masimo sensor		

C~D

Brand	Compatible Models	P/N	Description	Male Connector	Female Connector
Corpuls	(Masimo + Oximax tech)	U783-3BL	25 pin-DB9F, 2.4m fit for Masimo+Oximax sensor		
		U783-3CL	25 pin-8J, 2.4m fit for Masimo+Oximax sensor		
		U783-3JL	25 pin-DB15F, 2.4m fit for Masimo+Oximax sensor		
Colin	BP88/BP306S	U741-3AL	14 pin-DB9F, 2.4m fit for Nellcor sensor		
	BX 10NE (Oximax tech)	U741-4BL	14pin-DB9F, 2.4m fit for Oximax sensor		
Datex Ohmeda	Datex:AS/3 , CS/3, CH/S, CH/2S, CH-RS,CG/2S, Cardiocap I, Cardiocap II,Cardiocap 5, Capnomac Ultima,Light Monitor: M-Estrp,Oscar II,OSP-200, Satlite Trans,Satlite Trans Plus,System 5ULTS00,ULTSIO,ULTSVI,ULVO,original factory code:SAF-F4	U706-3AL	10 pin-DB9F, 2.4m fit for Nellcor sensor		
		U706-4DL	10 pin-DB9F, 2.4m fit for Ohmeda sensor (TS-N3)		
		U706-4FL	10 pin-8 pin, 2.4m fit for Ohmeda sensor (OXY-SL3)		
Datex Ohmeda	Datex-Ohmeda: 3750, 3710, 5700 OxiCap, 5250 RGM, Biox 3760, Ohmeda 3700, 3770, 3775, 3800, Rascal II,GE Medical Systems: 7000 Series, Corometrics 511, TRAM A.R., OXY-W5-H, TRAM Modular x00SL Series, 200SL, 500SL, 600SL, 800A, 800SL; Mennen: Horizon XL800	U711-1AL	7 pin-DB9F, 2.4m fit for Ohmeda sensor		
		U711-2DL	7 pin-DB9F, 2.4m fit for Ohmeda sensor (TS-H3)		

D~D

Brand	Compatible Models	P/N	Description	Male Connector	Female Connector
Datex Ohmeda	Datex-Ohmeda: 3750, 3710, 5700 OxiCap, 5250 RGM, Biox 3760, Ohmeda 3700, 3770, 3775, 3800, Rascal II,GE Medical Systems: 7000 Series, Corometrics 511, TRAM A.R., OXY-W5-H, TRAM Modular x00SL Series, 200SL, 500SL, 600SL, 800A, 800SL; Mennen: Horizon XL800	U711-2FL	7 pin-8 pin, 2.4m fit for Ohmeda sensor (OXY-OL3)		
Datascope	(Masimo + Oximax tech)	U714-1AL	8 pin-DB9F, 2.4m fit for Datascope sensor		
		U714-3BL	14 pin-DB9F, 2.4m fit for Masimo+Oximax sensor		
		U714-4AL	6 pin 40°-DB9F, 2.4m fit for Nellcor sensor		
Digicare	Digimax 5500	U781-1AL	7 pin 40°-DB9F, 2.4m fit for Nellcor sensor		
		U781-3AL	9 pin-DB9F, 2.4m fit for Nellcor sensor		
		U781-4AL	14 pin-DB9F, 2.4m fit for Nellcor sensor		
Dixtal		U795-1AL	7 pin-DB9F, 2.4m fit for Dixtal sensor		
		U795-2AL	6 pin-DB9F, 2.4m fit for Dixtal sensor		
DRE	(Digital tech)	U779-1AL	5 pin 40°-DB9F, 2.4m fit for Digital sensor		

D~G

Brand	Compatible Models	P/N	Description	Male Connector	Female Connector
DRE		U779-2AL	7 pin-DB9F, 2.4m fit for BCI sensor		
		U779-3AL	6 pin-DB9F, 2.4m fit for Nellcor sensor		
Ecomed	(Digital tech)	U7156-1AL	6 pin-DB9F, 2.4m fit for Digital sensor		
	EPM-50	U7156-2AL	6 pin 40°-DB9F, 2.4m fit for Nellcor sensor		
Edan	(Digital tech)	U772-1AL	5 pin-DB9F, 2.4m fit for Digital sensor		
	M9	U772-2AL	6 pin 40°-DB9F, 2.4m fit for Nellcor sensor		
	M9, M99A, M8, M8A, M8B, M3, M3B (Oximax tech)	U772-4HL	8 pin-DB9F, 2.4m fit for Oximax sensor		
Fukuda Denshi		U769-2BL	14 pin-DB9F, 2.4m fit for Oximax sensor		
Goldway	UT4000A	U708-2AL	5 pin-DB9F, 2.4m fit for Nellcor sensor		
	4000B	U708-3AL	7 pin 40°-DB9F, 2.4m fit for Nellcor sensor		

G~G

Brand	Compatible Models	P/N	Description	Male Connector	Female Connector
Goldway	(Oximax tech)	U708-5HL	7 pin-DB9F, 2.4m fit for Oximax sensor		
GE Trusat	GE Ohmeda TruSat, TruSat ED, TruSat TD	U702-1DL	9 pin-DB9F, 2.4m fit for Ohmeda sensor (TS-M3)		
		U702-1FL	9 pin-8 pin, 2.4m fit for Ohmeda sensor (OXY-MC3)		
GE Trusignal	GE Trusignal	U702-2DL	9 pin-DB9F, 2.4m fit for Ohmeda sensor		
GE	GE Medical Systems: Eagle Dash, Solar series TRAM Modular×50XL Series (Nellcor tech)	U702-4AL	11 pin-DB9F, 2.4m fit for Nellcor sensor		
		U702-5BL	11 pin-DB9F, 2.4m fit for Masimo sensor		
		U702-5CL	11 pin-6J, 2.4m fit for Masimo sensor		
		U702-5JL	11 pin-DB15F, 2.4m fit for Masimo sensor		
		U702-6DL	11 pin-DB9F, 2.4m fit for Ohmeda sensor (TS-G3)		
	Dash 2000,2500,3000, 5000, Solar 7000,8000; Eagle:1000,3000,SMK,SMV (Masimo tech)	U702-6FL	11 pin-8pin, 2.4m fit for Ohmeda sensor (OXY-ES3)		
	S/5,i4, Corometrics 259 with trusignal ohmeda tech (Ohmeda module)				





















G~I

Brand	Compatible Models	P/N	Description	Male Connector	Female Connector
GE	Dash2500,3000,4000,5000,5800 with Oxi-tech,Solar 8000,8000M, i9500 with tram module 451N5, 851N5. (Oximax tech)	U702-7HL	11 pin-DB9F, 2.4m fit for Oximax sensor (2021406-001)		
	B20, B40, B650 (Original Oximax chips)	U702-11BL	11 pin-DB9F, 2.4m fit for Oximax sensor		
	B20, B40, B650 (Masimo + Oximax tech)	U702-13BL	11 pin-DB9F, 2.4m fit for Masimo+Oximax sensor		
		U702-13CL	11 pin-8J, 2.4m fit for Masimo+Oximax sensor		
Generra / Pace Tech	Generra: 710, 200, 300, 400, 810, 530.Pace Techs Model 520, with black face (except for Vitalmax 800w Nellcor).	U730-1AL	5 pin-DB9F, 2.4m fit for Nellcor sensor		
		U730-2AL	7 pin-DB9F, 2.4m fit for Nellcor sensor		
Guoteng	GT,5000,6000,9000	U776-1AL	6 pin-DB9F, 2.4m fit for Nellcor sensor		
Heal Force	(Digital tech)	U778-1AL	5 pin 80°-DB9F, 2.4m fit for Digital sensor		
Huntleigh		U777-1AL	7 pin-DB9F, 2.4m fit for BCI sensor		
Infinium	(Digital tech)	U767-1AL	5 pin-DB9F, 2.4m fit for Digital sensor		



















I~M

Brand	Compatible Models	P/N	Description	Male Connector	Female Connector
Infinium	(Digital tech)	U767-2AL	5 pin 40°-DB9F, 2.4m fit for Digital sensor		
	OMNI III	U767-3AL	6 pin-DB9F, 2.4m fit for Nellcor sensor		
		U767-4AL	10 pin-DB9F, 2.4m fit for Nellcor sensor		
		U767-5HL	12 pin-DB9F, 2.4m fit for Oximax sensor		
Kontron	Kontron:7138,7840,7845, Minimon 7137,Y7337, Micromon,Supermon,Kolormon, Trakmon	U729-1AL	12 pin-DB9F, 2.4m fit for Nellcor sensor		
Kernel Medical		U774-1AL	5 pin-DB9F, 2.4m fit for Nellcor sensor		
		U774-2AL	6 pin-DB9F, 2.4m fit for Nellcor sensor		
Mindray		U703-4AL	5 pin-DB9F, 2.4m fit for Nellcor sensor		
Mindray	PM7000,6201,8000,9000,MEC-1000, MEC-1200,MEC-2000... (Nellcor tech)	U703-5AL	6 pin 40°-DB9F, 2.4m fit for Nellcor sensor		
		U703-6AL	6 pin 60°-DB9F, 2.4m fit for Nellcor sensor		

M~M

Brand	Compatible Models	P/N	Description	Male Connector	Female Connector
Mindray	PM7000,6201,8000,9000,MEC-1000, MEC-1200,MEC-2000... (Nellcor tech)	U703-7AL	6 pin 80°-DB9F, 2.4m fit for Nellcor sensor		
	PM9000,PM9100,PM9200,PM6201, PM7000,PM8000(before 2006) (Masimo tech)	U703-8BL	6 pin 40°-DB9F, 2.4m fit for Masimo sensor		
		U703-8CL	6 pin 40°-6J, 2.4m fit for Masimo sensor		
	PM9000,PM9100,PM9200,PM6201, PM7000,PM8000(before 2006) (Masimo tech)	U703-9BL	6 pin 60°-DB9F, 2.4m fit for Masimo sensor		
		U703-9CL	6 pin 60°-6J, 2.4m fit for Masimo sensor		
	VS800 (Masimo tech)	U703-10BL	6 pin 80°-DB9F, 2.4m fit for Masimo sensor		
		U703-10CL	6 pin 80°-6J, 2.4m fit for Masimo sensor		
	(Oximax tech)	U703-11HL	6 pin 40°-DB9F, 2.4m fit for Oximax sensor		
		U703-12HL	6 pin 60°-DB9F, 2.4m fit for Oximax sensor		
		U703-13HL	6 pin 80°-DB9F, 2.4m fit for Oximax sensor		

M~M









Brand	Compatible Models	P/N	Description	Male Connector	Female Connector
Mindray	BeneView T8, T5, T1,uMEC, iPM-9800, iPM-12, iPM 10, iPM 8, iMEC 12, iMEC10, iMEC 8, BeneHeart D6, BeneHeart D3, VS-600, VS-900 (Nellcor tech)	U703-14AL	7 pin-DB9F, 2.4m fit for Nellcor sensor		
	BeneView T8, T5, T1,uMEC, iPM-9800, iPM-12, iPM 10, iPM 8, iMEC 12, iMEC10, iMEC 8, BeneHeart D6, BeneHeart D3, VS-600, VS-900 (Masimo tech)	U703-15BL	7 pin-DB9F, 2.4m fit for Masimo sensor		
		U703-15CL	7 pin-6J, 2.4m fit for Masimo sensor		
	BeneView T8, T5, T1,uMEC, iPM-9800, iPM-12, iPM 10, iPM 8, iMEC 12, iMEC10, iMEC 8, BeneHeart D6, BeneHeart D3, VS-600, VS-900 (Oximax tech)	U703-17HL	8 pin-DB9F, 2.4m fit for Oximax sensor		
		U703-18BL	8 pin-DB9F, 2.4m fit for Masimo+Oximax sensor		
	BeneView T8, T5, T1,uMEC, iPM-9800, iPM-12, iPM 10, iPM 8, iMEC 12, iMEC10, iMEC 8, BeneHeart D6, BeneHeart D3, VS-600, VS-900 (Masimo + Oximax tech)	U703-18CL	8 pin-8J, 2.4m fit for Masimo+Oximax sensor		
		PM5000, PM6000 (BCI tech)	U703-19AL	12 pin-DB9F, 2.4m fit for BCI sensor	
	PM5000, PM6000 (Masimo tech)	U703-20BL	12 pin-DB9F, 2.4m fit for Masimo sensor		
		U703-20CL	12 pin-6J, 2.4m fit for Masimo sensor		
		PM5000, PM6000 (Nellcor tech)	U703-21AL	12 pin-DB9F, 2.4m fit for Nellcor sensor	



















M~M

Brand	Compatible Models	P/N	Description	Male Connector	Female Connector
Masimo	All Masimo monitors;MDE: Escort II OPT30 (Prism;GE Marquette: Dinamap ProCare with Masimo Pro1000, ProSeries V2,V300; Invivo T8; Schiller:Zoll; Datascope: Passport Trio, Passport 2,Passport XG and Spectrum; Bitmos:sat 800, sat 801,sat 805,sat 816,satPuls, Philips Respironics Alice 5 Diagnostic Sleep System (Masimo tech)	U719-6BL	14 pin-DB9F, 2.4m fit for Masimo sensor		
		U719-6CL	14 pin-6J, 2.4m fit for Masimo sensor		
	(Masimo + Oximax tech)	U719-7BL	20 pin-DB9F, 2.4m fit for Masimo+Oximax sensor		
		U719-7CL	20 pin-8J, 2.4m fit for Masimo+Oximax sensor		
		U719-7JL	20 pin-DB15F, 2.4m fit for Masimo+Oximax sensor		
	(Masimo + Oximax tech)	U719-8BL	14 pin-DB9F, 2.4m fit for Masimo+Oximax sensor		
		U719-8CL	14 pin-8J, 2.4m fit for Masimo+Oximax sensor		
		U719-8JL	14 pin-DB15F, 2.4m fit for Masimo+Oximax sensor		
	(Masimo + Oximax tech)	U719-5JL	11 pin-DB15F, 2.4m fit for Masimo+Oximax sensor		
		U719-1BL	6 pin-DB9F, 2.4m fit for Masimo sensor		

M~M

Brand	Compatible Models	P/N	Description	Male Connector	Female Connector
Masimo		U719-1BS	6 pin-DB9F, 0.2m fit for Masimo sensor		
		U719-2BL	7 pin-DB9F, 2.4m fit for Masimo sensor		
		U719-2BS	7 pin-DB9F, 0.2m fit for Masimo sensor		
		U719-2CL	7 pin-6J, 2.4m fit for Masimo sensor		
		U719-2CS	7 pin-6J, 0.2m fit for Masimo sensor		
		U719-4BL	8 pin-DB9F, 2.4m fit for Masimo sensor		
		U719-4CL	8 pin-6J, 2.4m fit for Masimo sensor		
MEK	MP100,MP110,MP500,MP600, MP 1000 (MEK tech)	U713-1AL	6 pin-DB9F, 2.4m fit for MEK sensor		
	(MEK tech)	U713-2AL	7 pin-DB9F, 2.4m fit for MEK sensor		
	(MEK tech)	U713-3AL	8 pin-DB9F, 2.4m fit for MEK sensor		

Brand	Compatible Models	P/N	Description	Male Connector	Female Connector
MEK	(Nellcor tech)	U713-4AL	8 pin-DB9F, 2.4m fit for Nellcor sensor		
	(Nellcor tech)	U713-5AL	7 pin-DB9F, 2.4m fit for Nellcor sensor		
Mediana	Lucon, YM6000, YM1000, YM5500	U764-1BL	14 pin-DB9F, 2.4m fit for Oximax sensor		
M&B	M&B:CD2000, MB526T	U717-1AL	6 pin-DB9F, 2.4m fit for Nellcor sensor		
	M&B526+Ohmeda Module	U717-2AL	7 pin-DB9F, 2.4m Fit for Ohmeda sensor		
	M&B 800-HS	U717-3AL	7 pin-DB9F, 2.4m fit for Nellcor sensor		
Mennen		U720-1AL	8 pin-DB9F, 2.4m fit for Nellcor sensor		
	(Digital tech)	U720-2AL	6 pin 40°-DB9F, 2.4m fit for Digital sensor		
	(Oximax tech)	U720-3HL	12 pin-DB9F, 2.4m fit for Oximax sensor		
Nellcor	Nellcor: N100,N180,N200,N-20,NPB-150,NPB-75,NPB-290,NPB-295,N-390,N-395,N-3000,N-6000 (Nellcor tech)	U701-1AL	7 pin-DB9F, 2.4m fit for Nellcor sensor (EC-8)		

Brand	Compatible Models	P/N	Description	Male Connector	Female Connector
Nellcor	Nellcor: N100,N180,N200,N-20,NPB-150,NPB-75,NPB-290,NPB-295,N-390,N-395,N-3000,N-6000 (Nellcor tech)	U701-1AS	7 pin-DB9F, 1.2m fit for Nellcor sensor (EC-4)		
		U701-2HL	9 pin-DB9F, 2.4m fit for Oximax sensor (DEC-8)		
	All Nellcor & Nellcor equipped, including NBP195, Philips Viridia A3. OEM monitors not listed above. (Oximax tech)	U701-2HS	9 pin-DB9F, 1.2m fit for Oximax sensor (DEC-4)		
	(Oximax tech)	U701-2K	9 pin-DB9F, wireless fit for Oximax sensor		
	Nellcor: N-560, N-595, N-600, N-600x, Huntleigh monitors and Cardio Aid 200 Defibrillators. (Oximax tech)	U701-3BL	14 pin-DB9F, 2.4m fit for Oximax sensor (DOC-10)		
	Datascope: Accutorr plus (nellcor), Nellcor: NPB-290/5, N-390, N395, N3000, N6000. Nihon Kodden: BSM-4104A, BSM-4114A; Colin BP88/306. (Nellcor tech)	U701-4AL	14 pin-DB9F, 2.4m fit for Nellcor sensor (SCP-10)		
Nihon Kohden	BSM-1101 LifeScope EC, BSM-2101/2 LifeScope L, BSM-3101 lifeScope LC, BSM-7100/7200 LifeScope 8, BSM-8200/1 lifeScope 12, BSM-8301/2 lifeScope 9, SM-8800 LifeScope 14, OLV 1100A	U705-2GL	10 pin-DB9F, 2.4m fit for Nihon Kohden sensor		
	BSM4101, 4103, 4111, 4113 Life scope P; BSM-5105, 5135 Life scope A; BSM-2351, 2353 Life scope L; BSM-2301, 2303, Life scope I	U705-3GL	14 pin-DB9F, 2.4m fit for Nihon Kohden sensor		
	(Oximax tech)	U705-4HL	14 pin-DB9F, 2.4m fit for Oximax sensor		
	OPV-1500, OPV-3100	U705-6GL	20 pin-DB9F, 2.4m fit for Nihon Kohden sensor		

Brand	Compatible Models	P/N	Description	Male Connector	Female Connector
Nihon Kohden	SVM 7521, SVM 7621	U705-7GL	9 pin 40°-DB9F, 2.4m fit for Nihon Kohden sensor		
		U740-1AL	5 pin-DB9F, 2.4m fit for Digital sensor		
	PM9300,PM90,PM900A (Digital tech)	U740-2AL	5 pin 80°-DB9F, 2.4m fit for Digital sensor		
	PM9300,PM90,PM900A,G2A Vital Signs Monitor, G3A,G3C,G3D,G3F, G3G,G3H Patient monitor (Digital tech)	U740-3AL	6 pin 40°-DB9F, 2.4m fit for Digital sensor		
Newtech / GMI	NT2A (Digital tech)	U740-5AL	8 pin-DB9F, 2.4m fit for Digital sensor		
	NT3A (Digital tech)	U740-6AL	12 pin-DB9F, 2.4m fit for Digital sensor		
	(Digital tech)	U740-7AL	12 pin-DB9F, 2.4m fit for Digital sensor		
	(Oximax tech)	U740-8HL	8 pin-DB9F, 2.4m fit for Oximax sensor		
	NT3B (Oximax tech)	U740-9HL	12 pin-DB9F, 2.4m fit for Oximax sensor		
Nonin	8604,8604D	U721-1AL	6 pin-DB9F, 2.4m fit for Nonin sensor		

N~N

Brand	Compatible Models	P/N	Description	Male Connector	Female Connector
Nonin	Nonin:8500,8600,8700,8800,9600,9700	U721-2AL	8 pin-DB9F, 2.4m fit for Nonin sensor		
	Nonin:8500,8600,8700,8800,2500	U721-3AL	9 pin-DB9F, 2.4m fit for Nonin sensor		
Novamatrix	505,510,511,515B/C,520,7000,7100,Oxypleth;	U716-1AL	7 pin-DB9F, 2.4m fit for Novamatrix sensor		
Penlon	Penlon Intermed Patient monitor (Nellcor tech)	U763-1AL	7 pin-DB9F, 2.4m fit for Nellcor sensor		
	Penlon Intermed Patient monitor (Masimo tech)	U763-2BL	7 pin-DB9F, 2.4m fit for Masimo sensor		
		U763-2CL	7 pin-6J, 2.4m fit for Masimo sensor		
Philips		U704-1AL	8 pin-DB9F, 2.4m fit for Nellcor sensor		
	Viridia 24C,C1,C3,M3,M4,MP20,MP30,MP40,MP50,MP70,MP80,VM4,VM6,VM8,M2601A,M3000A,M6500B,M4735A (Philips/Nellcor tech)	U704-1EL	8 pin-8 pin, 2.4m fit for Philips sensor		
		U704-1ES	8 pin-8 pin, 1.2m fit for Philips sensor		
	Viridia 24C,C1,C3,M3,M4,MP20,MP30,MP40,MP50,MP70,MP80,VM4,VM6,VM8,M2601A,M3000A,M6500B,M4735A (Masimo tech)	U704-2BL	8 pin-DB9F, 2.4m fit for Masimo sensor		

N~P

P~P

Brand	Compatible Models	P/N	Description	Male Connector	Female Connector
Philips	Viridia 24C,C1,C3,M3,M4,MP20 IMP30,MP40,MP50,MP70,MP80,VM4,VM6, VM8,M2601A,M3000A,M6500B,M4735A (Masimo tech)	U704-2CL	8 pin-6J, 2.4m fit for Masimo sensor		
	Viridia 24C,C1,C3,M3,M4,MP20 IMP30,MP40,MP50,MP70,MP80,VM4,VM6, VM8,M2601A,M3000A,M6500B,M4735A (Oximax tech)	U704-3HL	8 pin-DB9F, 2.4m fit for Oximax sensor		
	Philips 78352A/C, 78355A/C, 78835C,M1020A,M1025A/B, M1205A, M1350B, M1722A/B, M1723A/B,M2575B,V25. (Philips/Nellcor tech)	U704-4AL	12 pin-DB9F, 2.4m fit for Nellcor sensor		
		U704-4EL	12 pin-8 pin, 2.4m fit for Philips sensor		
		U704-4ES	12 pin-8 pin, 1.2m fit for Philips sensor		
	Philips 78352A/C, 78355A/C, 78835C,M1020A,M1025A/B, M1205A, M1350B, M1722A/B, M1723A/B,M2575B,V25. (Masimo tech)	U704-5BL	12 pin-DB9F, 2.4m fit for Masimo sensor		
U704-5CL		12 pin-6J, 2.4m fit for Masimo sensor			
Palco		U731-1AL	6 pin-DB9F, 2.4m fit for Nellcor sensor		
		U731-2AL	8 pin-DB9F, 2.4m fit for Nellcor sensor		
Prolife	P10 (Oximax tech)	U791-1HL	7 pin-DB9F, 2.4m fit for Oximax sensor		





















R~S

Brand	Compatible Models	P/N	Description	Male Connector	Female Connector
Risingmed	RMP9000C	U788-1AL	5 pin-DB9F, 2.4m fit for Nellcor sensor		
Spacelabs	Spacelabs: 90351-0/6, 90309, 90465, 0466, 90489, 90651-A, IM77, 90308, PC Scout	U707-1AL	7 pin-DB9F, 2.4m fit for Nellcor sensor		
		U707-2AL	10 pin-DB9F, 2.4m fit for Nellcor sensor		
		U707-3HL	10 pin-DB9F, 2.4m fit for Oximax sensor		
		U707-4BL	10 pin-DB9F, 2.4m fit for Masimo+Oximax sensor		
		U707-4CL	10 pin-8J, 2.4m fit for Masimo+Oximax sensor		
Siemens	Siemens Drager: SC6002XL, 7000, SC8000, SC9000X, Infinity Vista and Infinity Delta, Infinity Delta XL .	U715-1AL	7 pin-DB9F, 2.4m fit for Nellcor sensor		
		U715-1AS	7 pin-DB9F, 1.2m fit for Nellcor sensor		
		U715-2HL	7 pin-DB9F, 2.4m fit for Oximax sensor		
		U715-3BL	7 pin-DB9F, 2.4m fit for Masimo sensor		

Brand	Compatible Models	P/N	Description	Male Connector	Female Connector
Siemens	(Masimo tech)	U715-3CL	7 pin-6J, 2.4m fit for Masimo sensor		
	(Masimo + Oximax tech)	U715-5BL	7 pin-DB9F, 2.4m fit for Masimo+Oximax sensor		
		U715-5CL	7 pin-8J, 2.4m fit for Masimo+Oximax sensor		
	(Masimo + Oximax tech) Direct connect Chips	U715-7BL	7 pin-DB9F, 2.4m fit for Masimo+Oximax sensor		
		U715-7CL	7 pin-8J, 2.4m fit for Masimo+Oximax sensor		
	Siemens Medical:Sirecust 700,Sirecust 630,Sirem SpO2 Module	U715-4AL	10 pin-DB9F, 2.4m fit for Nellcor sensor		
	Drager medical: Vitalert 1000, Cicero	U715-6AL	8 pin-DB9F, 2.4m fit for Nellcor sensor		
Schiller	Truscope	U725-1AL	6 pin-DB9F, 2.4m fit for Nellcor sensor		
	Schiller Argus CM8, SM783, SM784, SM785, TM910,TM-7 (Nellcor tech)	U725-2AL	7 pin-DB9F, 2.4m fit for Nellcor sensor		
	Argus Pro, Argus LCM ,ASAT, S-50/100/100A (Masimo Tech)	U725-3BL	7 pin-DB9F, 2.4m fit for Masimo sensor		

Brand	Compatible Models	P/N	Description	Male Connector	Female Connector
Schiller		U725-3CL	7 pin-6J, 2.4m fit for Masimo sensor		
	LCM New Argus (Oximax tech)	U725-4HL	8 pin-DB9F, 2.4m fit for Oximax sensor		
		U725-7BL	8 pin-DB9F, 2.4m fit for Masimo+Oximax sensor		
	Argus LCM Plus (Masimo + Oximax tech)	U725-7CL	8 pin-8J, 2.4m fit for Masimo+Oximax sensor		
		U725-5HL	12 pin-DB9F, 2.4m fit for Oximax sensor		
	Argus LSM (Masimo + Oximax tech)	U725-6BL	12 pin-DB9F, 2.4m fit for Masimo+Oximax sensor		
		U725-6CL	12 pin-8J, 2.4m fit for Masimo+Oximax sensor		
Shanghai 3F	Diona PMS-8100; IRIS300/IRIS400; Phoebe PMS8300/8310; Phoebe PROPMS8300/8310 PMS8110A	U749-1AL	6 pin-DB9F, 2.4m fit for Nellcor sensor		
Tomorrow	TR-900E	U750-1AL	5 pin-DB9F, 2.4m fit for Nellcor sensor		
		U750-2AL	6 pin 40°-DB9F, 2.4m fit for Nellcor sensor		

Brand	Compatible Models	P/N	Description	Male Connector	Female Connector
Tomorrow	TR-900J (Digital tech)	U750-3AL	6 pin-DB9F, 2.4m fit for Digital sensor		
Unicare		U758-1AL	6 pin-DB9F, 2.4m fit for Nellcor sensor		
	(Digital tech)	U758-2AL	5 pin-DB9F, 2.4m fit for Digital sensor		
	(Digital tech)	U758-3AL	6 pin-DB9F, 2.4m fit for Digital sensor		
	(Digital tech)	U758-4AL	12 pin-DB9F, 2.4m fit for Digital sensor		
Weinmann		U766-1HL	6 pin-DB9F, 2.4m fit for Oximax sensor		
ZOLL	(Masimo + Oximax tech)	U747-2BL	14 pin-DB9F, 2.4m fit for Masimo+Oximax sensor		
		U747-2CL	14 pin-8J, 2.4m fit for Masimo+Oximax sensor		
Zoncare		U799-1AL	6 pin-DB9F, 2.4m fit for Nellcor sensor		
	(Digital tech)	U799-2AL	6 pin-DB9F, 2.4m fit for Digital sensor		

Brand	Compatible Models	P/N	Description	Male Connector	Female Connector
Zondan		U755-1AL	6 pin-DB9F, 2.4m fit for Nellcor sensor		
		U755-2BL	8 pin 40°-DB9F, 2.4m fit for Masimo+Oximax sensor		
	Apollo N1 (Masimo + Oximax tech)	U755-2CL	8 pin 40°-8J, 2.4m fit for Masimo+Oximax sensor		
		U755-2JL	8 pin 40°-DB15F, 2.4m fit for Masimo+Oximax sensor		
	(Masimo + Oximax tech)	U755-3BL	14 pin-DB9F, 2.4m fit for Masimo+Oximax sensor		
		U755-3CL	14 pin-8J, 2.4m fit for Masimo+Oximax sensor		
	(Digital tech)	U755-4AL	6 pin-DB9F, 2.4m fit for Digital sensor		
		U755-5BL	8 pin-DB9F, 2.4m fit for Masimo+Oximax sensor		
		U755-5CL	8 pin-8J, 2.4m fit for Masimo+Oximax sensor		
	Apollo N3 (Masimo + Oximax tech)	U755-5JL	8 pin-DB15F, 2.4m fit for Masimo+Oximax sensor		



ECG Cable with Leadwires

U301-13SA — A:AHA E:IEC G:Original AHA or AHA/IEC H:Original IEC

S:Snap C:Clip M:Mini clip A:AA clip Q:Q type clip
B:Banana D:Din

3:3 Lead 4:4 Lead 5:5 Lead 6:6 Lead

1: Different model No

01: Compatible brand No (02: GE)

3: ECG Cable No

UpnMed

ECG CABLE

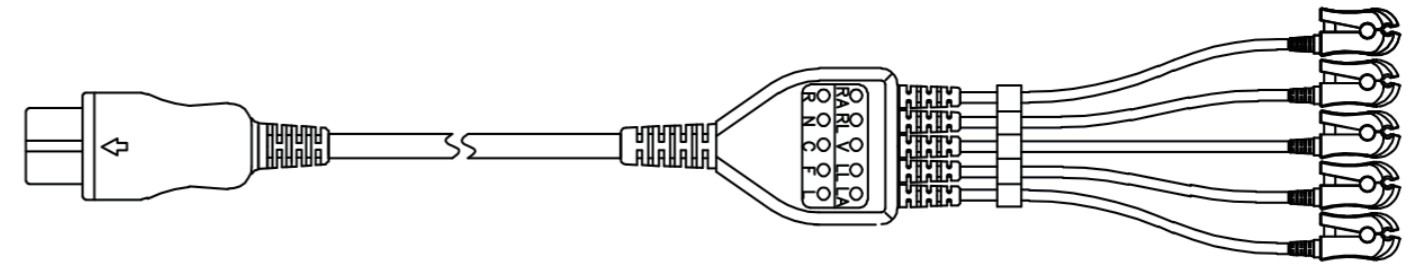

PATIENT CONNECTION DIAGRAM

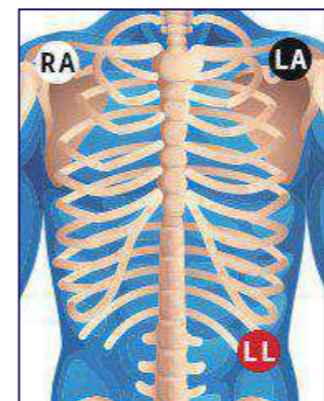

3 lead(AHA standard)

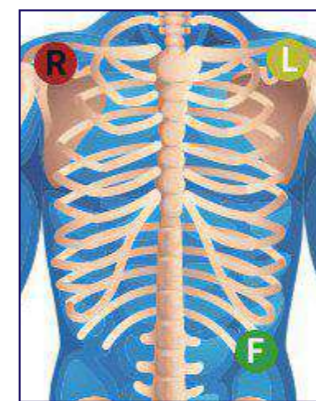

3 lead(IEC standard)

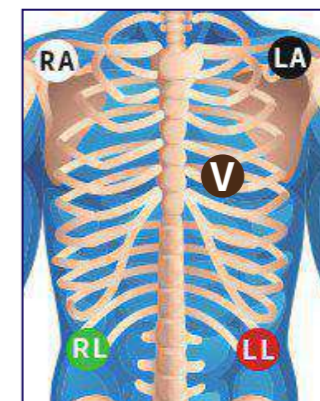

5 lead(AHA standard)

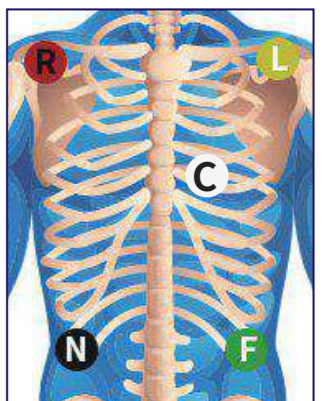

5 lead(IEC standard)

Patient Connect side



Snap



Clip



Mini clip

HOT PRODUCT DISPLAY



Brand/Compatible NO	P/N	Description	Image
Normal ECG Cable (6 pin)			
Abbott Medical: EX-50, Lifecare 5100, Lifecare 5200; Advanced Instrumentations: PM-1000, PM-1000EX; Air Shields: HRRM-71-1/2, Porta-Fib I, II, III, System5, System6; ALT: 800, 800Plus, CX ATL, Ultrasonic, CX200, CX400, Apogee, HDI 9/200, Interspec Cardiology XL, Mark IV, Mark VII, Ultramark 4/5/7/9; Analogic: Lifegard II (Requires cable with resistance); BCI Biochem International (Smiths Medical): 3101, 3404, 6100, 6200, 9100, 9200; Advisor: Autocorr, Surgivet; Cardell 9403V, 9405, Max-1; Carewell CPM-8000; Colin: BP308, BP408, CBM3000; Criticare: 504US, 504USP, 506, 507, 507E, 507ELC2, 507S, 508, 602-4B, 602-4USP, 1100, 2200, Poet 2, Scholar, nCompass, nGenuity 8100E, 8100E; Digicare LW600; Draeger Vitalert 2000, Vitalert 3000; Edam: M8, M8A, M8B, M8, M8A, M80, M80; GE: Coronometrics 556, Critikon 8100T, Dinamap 8700/9700, Critikon Dinamap MPS Select, Dinamap Pro 1000; Guthan: 1000; Infinium Medical: Infron II, IVY Biomedical: 101 (before 1989), 402, 700; LSI: LS5, 261; MDE: Escort 100, 101, 102, 200, 300, Prism, 360SL, 450SL, 521A, Portapak 80, Portapak 90/1000; Mindray: MEC 200, MEC 1000, MEC 1200, MEC 2000; Ohmeda: enGuard CM5; Physio Control (Medtronic): Lifepak 5, Lifepak 6, Lifepak 6S, Lifepak 7, Lifepak 8, Lifepak 9, Lifepak 10, Physio 1440R, VSM-1ESF, VSM-2, VSM-2ESF, VSM-3, Nellcor: N-200, N-250, C-LOCK, N-1000, NPB-3900, NPB-4000; Nihon Kohden: BSM-8301A, 8302A, 8500A, 8502A, OEC-6102A (s/n>20156), 7102A, 8108A, OEC-6105A (s/n>20226), TEC 5531E, TEC-7100A, TEC-5200A (s/n>20421), TEC-7200A, 7300A; Novametric: 902, 903, 910, Life Defense 1; Pace Tech: Minipack 300, Minipack 3000/3100, MiniMax 4000CL, Vitalmax 800 Plus, 2100, 2200, 4000, 4100, Vitalmax 4000CL, 4000, Modular/4100CL; Palco; Philips: IE33 xMatrix Ultrasound CX50, M3921A A1, M3923A A1, M3925A A1, M3927A A3, M3929A A3; Pioneer (American Optical): 26125, 33167, 5260, 5330, Pulsar 4; PPG (Datamedix, Becton-Dickinson): Guardian 1001, N1001; Siemens: Sirecust 300DU, Sirecust 610, Sirecust 630, Sirecust DU, Cypress Ultrasound, Acuson CV70, Acuson C256, Acuson Sequoia 512; Spacelabs Burdick: Medic 3, Medic 4, Medic 5, Medic 6; Series 500, Series 600, Series 900, 90300, 90303, 90303B, 90400, 90600, 90603A, 90700 Series, TEK-208408/511/512/514/521, PCMS, 067112; Tektronix (Vitek): 4045 Defib/208400/500 Series; Welch Allyn: Propaq 100, Propaq 200 Series, Atlas Propaq Encore, Propaq CS, Ultra Smart, PIC 30, PIC 40, PIC 50; Zoll: M Series, E Series R Series, PD1200, PD1400, PD1600, PD1700, D900, PD2000, OEM: 8000-0025, 9500-0229	U301-13SA	3-lead ECG Cable with leadwires, Snap,AHA	
	U301-13SE	3-lead ECG Cable with leadwires, Snap,IEC	
	U301-13CA	3-lead ECG Cable with leadwires, Clip,AHA	
	U301-13CE	3-lead ECG Cable with leadwires, Clip,IEC	
	U301-13SA	5-lead ECG Cable with leadwires, Snap,AHA	
	U301-13SE	5-lead ECG Cable with leadwires, Snap,IEC	
	U301-13CA	5-lead ECG Cable with leadwires, Clip,AHA	
	U301-13CE	5-lead ECG Cable with leadwires, Clip,IEC	
	U301-15SA	5-lead ECG Cable with leadwires, Snap,AHA	
	U301-15SE	5-lead ECG Cable with leadwires, Snap,IEC	
	U301-15CA	5-lead ECG Cable with leadwires, Clip,AHA	
	U301-15CE	5-lead ECG Cable with leadwires, Clip,IEC	
Biolight(12 pin)			
A series:A3,A5,A6,A8	U309-13SA	3-lead ECG Cable with leadwires, Snap,AHA	
	U309-13SE	3-lead ECG Cable with leadwires, Snap,IEC	
	U309-13CA	3-lead ECG Cable with leadwires, Clip,AHA	
	U309-13CE	3-lead ECG Cable with leadwires, Clip,IEC	
	U309-15SA	5-lead ECG Cable with leadwires, Snap,AHA	
	U309-15SE	5-lead ECG Cable with leadwires, Snap,IEC	
U309-15CA	5-lead ECG Cable with leadwires, Clip,AHA		
U309-15CE	5-lead ECG Cable with leadwires, Clip,IEC		
Biolight (12 pin)			
M series:M8500,M7000,M8000,M9000,M9500,Q3	U309-23SA	3-lead ECG Cable with leadwires, Snap,AHA	
	U309-23SE	3-lead ECG Cable with leadwires, Snap,IEC	
	U309-23CA	3-lead ECG Cable with leadwires, Clip,AHA	
	U309-23CE	3-lead ECG Cable with leadwires, Clip,IEC	
	U309-25SA	5-lead ECG Cable with leadwires, Snap,AHA	
	U309-25SE	5-lead ECG Cable with leadwires, Snap,IEC	
U309-25CA	5-lead ECG Cable with leadwires, Clip,AHA		
U309-25CE	5-lead ECG Cable with leadwires, Clip,IEC		

Brand/Compatible NO	P/N	Description	Image		
Bionet (8 pin)					
BM3	U323-13SA	3-lead ECG Cable with leadwires, Snap,AHA			
	U323-13SE	3-lead ECG Cable with leadwires, Snap,IEC			
	U323-13CA	3-lead ECG Cable with leadwires, Clip,AHA			
	U323-13CE	3-lead ECG Cable with leadwires, Clip,IEC			
	U323-15SA	5-lead ECG Cable with leadwires, Snap,AHA			
	U323-15SE	5-lead ECG Cable with leadwires, Snap,IEC			
U323-15CA	5-lead ECG Cable with leadwires, Clip,AHA				
U323-15CE	5-lead ECG Cable with leadwires, Clip,IEC				
Bionet(12 pin)					
	U323-25SA	5-lead ECG Cable with leadwires, Snap,AHA			
	U323-25SE	5-lead ECG Cable with leadwires, Snap,IEC			
	U323-25CA	5-lead ECG Cable with leadwires, Clip,AHA			
	U323-25CE	5-lead ECG Cable with leadwires, Clip,IEC			
		U323-25CA		5-lead ECG Cable with leadwires, Clip,AHA	
Biosys(6 pin)					
BPM-103	U343-13SA	3-lead ECG Cable with leadwires, Snap,AHA			
	U343-13SE	3-lead ECG Cable with leadwires, Snap,IEC			
	U343-13CA	3-lead ECG Cable with leadwires, Clip,AHA			
	U343-13CE	3-lead ECG Cable with leadwires, Clip,IEC			
	U343-15SA	5-lead ECG Cable with leadwires, Snap,AHA			
	U343-15SE	5-lead ECG Cable with leadwires, Snap,IEC			
	U343-15CA	5-lead ECG Cable with leadwires, Clip,AHA			
U343-15CE	5-lead ECG Cable with leadwires, Clip,IEC				
Bruker(12 pin)					
SM784, SM785	U324-13SA	3-lead ECG Cable with leadwires, Snap,AHA			
	U324-13SE	3-lead ECG Cable with leadwires, Snap,IEC			
	U324-13CA	3-lead ECG Cable with leadwires, Clip,AHA			
	U324-13CE	3-lead ECG Cable with leadwires, Clip,IEC			
	U324-15SA	5-lead ECG Cable with leadwires, Snap,AHA			
	U324-15SE	5-lead ECG Cable with leadwires, Snap,IEC			
	U324-15CA	5-lead ECG Cable with leadwires, Clip,AHA			
U324-15CE	5-lead ECG Cable with leadwires, Clip,IEC				
Criticare(CSI)(6 pin)					
	U312-13SA	3-lead ECG Cable with leadwires, Snap,AHA			
	U312-13SE	3-lead ECG Cable with leadwires, Snap,IEC			
	U312-13CA	3-lead ECG Cable with leadwires, Clip,AHA			
	U312-13CE	3-lead ECG Cable with leadwires, Clip,IEC			
	U312-15SA	5-lead ECG Cable with leadwires, Snap,AHA			
	U312-15SE	5-lead ECG Cable with leadwires, Snap,IEC			
	U312-15CA	5-lead ECG Cable with leadwires, Clip,AHA			
	U312-15CE	5-lead ECG Cable with leadwires, Clip,IEC			
	Creative(6 pin)				
	PC9000S,PC9000,UP6000	U310-13SA		3-lead ECG Cable with leadwires, Snap,AHA	
		U310-13SE		3-lead ECG Cable with leadwires, Snap,IEC	
		U310-13CA		3-lead ECG Cable with leadwires, Clip,AHA	
U310-13CE		3-lead ECG Cable with leadwires, Clip,IEC			
U310-15SA		5-lead ECG Cable with leadwires, Snap,AHA			
U310-15SE		5-lead ECG Cable with leadwires, Snap,IEC			
U310-15CA		5-lead ECG Cable with leadwires, Clip,AHA			
U310-15CE		5-lead ECG Cable with leadwires, Clip,IEC			
Corpuls(11 pin)					
		U383-14SA	4-lead ECG Cable with leadwires, Snap,AHA		
	U383-14SE	4-lead ECG Cable with leadwires, Snap,IEC			
	U383-14CA	4-lead ECG Cable with leadwires, Clip,AHA			
	U383-14CE	4-lead ECG Cable with leadwires, Clip,IEC			
	U383-16SA	6-lead ECG Cable with leadwires, Snap,AHA			
	U383-16SE	6-lead ECG Cable with leadwires, Snap,IEC			
	U383-16CA	6-lead ECG Cable with leadwires, Clip,AHA			
	U383-16CE	6-lead ECG Cable with leadwires, Clip,IEC			
	Colin(6 pin)				
	BP88/BP306	U341-13SA	3-lead ECG Cable with leadwires, Snap,AHA		
U341-13SE		3-lead ECG Cable with leadwires, Snap,IEC			
U341-13CA		3-lead ECG Cable with leadwires, Clip,AHA			
U341-13CE		3-lead ECG Cable with leadwires, Clip,IEC			
U341-15SA		5-lead ECG Cable with leadwires, Snap,AHA			
U341-15SE		5-lead ECG Cable with leadwires, Snap,IEC			
U341-15CA		5-lead ECG Cable with leadwires, Clip,AHA			
U341-15CE		5-lead ECG Cable with leadwires, Clip,IEC			
Comen(12 pin)					
C50		U338-13SA	3-lead ECG Cable with leadwires, Snap,AHA		
	U338-13SE	3-lead ECG Cable with leadwires, Snap,IEC			
	U338-13CA	3-lead ECG Cable with leadwires, Clip,AHA			
	U338-13CE	3-lead ECG Cable with leadwires, Clip,IEC			
	U338-15SA	5-lead ECG Cable with leadwires, Snap,AHA			
	U338-15SE	5-lead ECG Cable with leadwires, Snap,IEC			
	U338-15CA	5-lead ECG Cable with leadwires, Clip,AHA			
U338-15CE	5-lead ECG Cable with leadwires, Clip,IEC				
Cas Med(7 pin)					
Cas Med	U385-13SA	3-lead ECG Cable with leadwires, Snap,AHA			
	U385-13SE	3-lead ECG Cable with leadwires, Snap,IEC			
	U385-13CA	3-lead ECG Cable with leadwires, Clip,AHA			
	U385-13CE	3-lead ECG Cable with leadwires, Clip,IEC			
Datascope(6 pin)					
2000,2001,2002,2100,2200,3000,3000A,Ballo Pump,M/D3 W/lead select,M/D3A,M/D4 Passport,Passport IL,Passport XG,Passport XL,Passport Z,Passport 2LT,Spectrum system 90,system 90T,system 96,system 97	U314-13SA	3-lead ECG Cable with leadwires, Snap,AHA			
	U314-13SE	3-lead ECG Cable with leadwires, Snap,IEC			
	U314-13CA	3-lead ECG Cable with leadwires, Clip,AHA			
	U314-13CE	3-lead ECG Cable with leadwires, Clip,IEC			
	U314-15SA	5-lead ECG Cable with leadwires, Snap,AHA			
	U314-15SE	5-lead ECG Cable with leadwires, Snap,IEC			
	U314-15CA	5-lead ECG Cable with leadwires, Clip,AHA			
	U314-15CE	5-lead ECG Cable with leadwires, Clip,IEC			
	Datascope(12 pin)				
	Datascope Mindray V12, V21	U314-23SA		3-lead ECG Cable with leadwires, Snap,AHA	
U314-23SE		3-lead ECG Cable with leadwires, Snap,IEC			
U314-23CA		3-lead ECG Cable with leadwires, Clip,AHA			
U314-23CE		3-lead ECG Cable with leadwires, Clip,IEC			
U314-25SA		5-lead ECG Cable with leadwires, Snap,AHA			
U314-25SE		5-lead ECG Cable with leadwires, Snap,IEC			
U314-25CA		5-lead ECG Cable with leadwires, Clip,AHA			
U314-25CE		5-lead ECG Cable with leadwires, Clip,IEC			
Datex(10 pin)					
AS/3,CS/3,S/5,Cardiocap 1,Cardiocap 2,Cardiocap 5,Light Monitor,Sateliteplus AS/3,Compact S/S Compact, Light Monitor, Satellite Plus S5, Aespire		U306-13SA	3-lead ECG Cable with leadwires, Snap,AHA		
	U306-13SE	3-lead ECG Cable with leadwires, Snap,IEC			
	U306-13CA	3-lead ECG Cable with leadwires, Clip,AHA			
	U306-13CE	3-lead ECG Cable with leadwires, Clip,IEC			
	U306-15SA	5-lead ECG Cable with leadwires, Snap,AHA			
	U306-15SE	5-lead ECG Cable with leadwires, Snap,IEC			
	U306-15CA	5-lead ECG Cable with leadwires, Clip,AHA			
	U306-15CE	5-lead ECG Cable with leadwires, Clip,IEC			
	Dixtal(6 pin)				
	DX405, DX2010, DX2020, DX2021, DX2405, DX2515(1KΩ resistor)	U395-13SA	3-lead ECG Cable with leadwires, Snap,AHA		
U395-13SE		3-lead ECG Cable with leadwires, Snap,IEC			
U395-13CA		3-lead ECG Cable with leadwires, Clip,AHA			
U395-13CE		3-lead ECG Cable with leadwires, Clip,IEC			
U395-15SA		5-lead ECG Cable with leadwires, Snap,AHA			
U395-15SE		5-lead ECG Cable with leadwires, Snap,IEC			
U395-15CA		5-lead ECG Cable with leadwires, Clip,AHA			
U395-15CE		5-lead ECG Cable with leadwires, Clip,IEC			
Edan(6 pin)					
		U372-13SA	3-lead ECG Cable with leadwires, Snap,AHA		
	U372-13SE	3-lead ECG Cable with leadwires, Snap,IEC			
	U372-13CA	3-lead ECG Cable with leadwires, Clip,AHA			
	U372-13CE	3-lead ECG Cable with leadwires, Clip,IEC			
	U372-15SA	5-lead ECG Cable with leadwires, Snap,AHA			
	U372-15SE	5-lead ECG Cable with leadwires, Snap,IEC			
	U372-15CA	5-lead ECG Cable with leadwires, Clip,AHA			
	U372-15CE	5-lead ECG Cable with leadwires, Clip,IEC			

Brand/Compatible NO	P/N	Description	Image		
Earphone connector(3.5mm)					
	U365-13SA	3-lead ECG Cable with leadwires, Snap,AHA			
	U365-13SE	3-lead ECG Cable with leadwires, Snap,IEC			
	U365-13CA	3-lead ECG Cable with leadwires, Clip,AHA			
	U365-13CE	3-lead ECG Cable with leadwires, Clip,IEC			
Earphone connector(2.5mm)					
	U365-23SA	3-lead ECG Cable with leadwires, Snap,AHA			
	U365-23SE	3-lead ECG Cable with leadwires, Snap,IEC			
	U365-23CA	3-lead ECG Cable with leadwires, Clip,AHA			
	U365-23CE	3-lead ECG Cable with leadwires, Clip,IEC			
Fukuda Denshi(12 pin)					
	U369-15SA	5-lead ECG Cable with leadwires, Snap,AHA			
	U369-15SE	5-lead ECG Cable with leadwires, Snap,IEC			
	U369-15CA	5-lead ECG Cable with leadwires, Clip,AHA			
	U369-15CE	5-lead ECG Cable with leadwires, Clip,IEC			
		U369-15CA		5-lead ECG Cable with leadwires, Clip,AHA	
Fukuda Denshi(12 pin)					
Mindray Datascope Expert and Fukuda Denshi Dynascope DS-5100, DS-5100E, DS-5300W, DS-5400, DS-7001	U369-23SA	3-lead ECG Cable with leadwires, Snap,AHA			
	U369-23SE	3-lead ECG Cable with leadwires, Snap,IEC			
	U369-23CA	3-lead ECG Cable with leadwires, Clip,AHA			
	U369-23CE	3-lead ECG Cable with leadwires, Clip,IEC			
	U369-25SA	5-lead ECG Cable with leadwires, Snap,AHA			
	U369-25SE	5-lead ECG Cable with leadwires, Snap,IEC			
	U369-25CA	5-lead ECG Cable with leadwires, Clip,AHA			
U369-25CE	5-lead ECG Cable with leadwires, Clip,IEC				
GE(6 pin)					
PRO1000(1KΩ resistor)	U302-13SA	3-lead ECG Cable with leadwires, Snap,AHA			
	U302-13SE	3-lead ECG Cable with leadwires, Snap,IEC			
	U302-13CA	3-lead ECG Cable with leadwires, Clip,AHA			
	U302-13CE	3-lead ECG Cable with leadwires, Clip,IEC			
	U302-15SA	5-lead ECG Cable with leadwires, Snap,AHA			
	U302-15SE	5-lead ECG Cable with leadwires, Snap,IEC			
	U302-15CA	5-lead ECG Cable with leadwires, Clip,AHA			
U302-15CE	5-lead ECG Cable with leadwires, Clip,IEC				
GE(11 pin)					
GEMS-Dash PRO 4000,Dash PRO 3000,Dash PRO 2000,Dash 1000,Eagle Systems,MAC-Lab,Solar 9500,Solar 8000,Solar 3000,Tram 100,Tram 200,Tram 300,Tram 400,Tram 500,Tram 600,Tram 800,Unity systems	U302-23SA	3-lead ECG Cable with leadwires, Snap,AHA			
	U302-23SE	3-lead ECG Cable with leadwires, Snap,IEC			
	U302-23CA	3-lead ECG Cable with leadwires, Clip,AHA			
	U302-23CE	3-lead ECG Cable with leadwires, Clip,IEC			
	U302-25SA	5-lead ECG Cable with leadwires, Snap,AHA			
	U302-25SE	5-lead ECG Cable with leadwires, Snap,IEC			
	U302-25CA	5-lead ECG Cable with leadwires, Clip,AHA			
U302-25CE	5-lead ECG Cable with leadwires, Clip,IEC				
GMI(NEUTECH)(12 pin)					
	U340-13SA	3-lead ECG Cable with leadwires, Snap,AHA			
	U340-13SE	3-lead ECG Cable with leadwires, Snap,IEC			
	U340-13CA	3-lead ECG Cable with leadwires, Clip,AHA			
	U340-13CE	3-lead ECG Cable with leadwires, Clip,IEC			
	U340-15SA	5-lead ECG Cable with leadwires, Snap,AHA			
	U340-15SE	5-lead ECG Cable with leadwires, Snap,IEC			
	U340-15CA	5-lead ECG Cable with leadwires, Clip,AHA			
	U340-15CE	5-lead ECG Cable with leadwires, Clip,IEC			
	GMI(NEUTECH)(6 pin)				
		U340-23SA		3-lead ECG Cable with leadwires, Snap,AHA	
U340-23SE		3-lead ECG Cable with leadwires, Snap,IEC			
U340-23CA		3-lead ECG Cable with leadwires, Clip,AHA			
U340-23CE		3-lead ECG Cable with leadwires, Clip,IEC			
U340-25SA		5-lead ECG Cable with leadwires, Snap,AHA			
U340-25SE		5-lead ECG Cable with leadwires, Snap,IEC			
U340-25CA		5-lead ECG Cable with leadwires, Clip,AHA			

Brand/Compatible NO	P/N	Description	Image
Primedec			
Primedec Defi-Monitor DM 10, DM30	U394-14SA	4-lead ECG Cable with leadwires, Snap,AHA	
	U394-14SE	4-lead ECG Cable with leadwires, Snap,IEC	
	U394-14CA	4-lead ECG Cable with leadwires, Clip,AHA	
	U394-14CE	4-lead ECG Cable with leadwires, Clip,IEC	
Primedec (3 pin)			
90492,91496, 90496,90369 ,90367 Ultraview	U394-23SA	3-lead ECG Cable with leadwires, Snap,AHA	
	U394-23SE	3-lead ECG Cable with leadwires, Snap,IEC	
	U394-23CA	3-lead ECG Cable with leadwires, Clip,AHA	
	U394-23CE	3-lead ECG Cable with leadwires, Clip,IEC	
Spacelabs (17 pin)			
Sirecust Series 400,500,600,Seirie 700,900,1200,Sirecust 341/610/620/630/720/722,Sirecust 730/732/900/960/961/1260,Sirecust 1281/1801/400/500, ECG Monitor,Polymed Modul,Modulobox Sirem	U307-13SA	3-lead ECG Cable with leadwires, Snap,AHA	
	U307-13SE	3-lead ECG Cable with leadwires, Snap,IEC	
	U307-13CA	3-lead ECG Cable with leadwires, Clip,AHA	
	U307-13CE	3-lead ECG Cable with leadwires, Clip,IEC	
	U307-15SA	5-lead ECG Cable with leadwires, Snap,AHA	
	U307-15CE	5-lead ECG Cable with leadwires, Clip,IEC	
Siemens (10 pin)			
U315-13SA	U315-13SA	3-lead ECG Cable with leadwires, Snap,AHA	
	U315-13SE	3-lead ECG Cable with leadwires, Snap,IEC	
	U315-13CA	3-lead ECG Cable with leadwires, Clip,AHA	
	U315-13CE	3-lead ECG Cable with leadwires, Clip,IEC	
	U315-15SA	5-lead ECG Cable with leadwires, Snap,AHA	
	U315-15CE	5-lead ECG Cable with leadwires, Clip,IEC	
Siemens (7 pin)			
U315-33SA	U315-33SA	3-lead ECG Cable with leadwires, Snap,AHA	
	U315-33SE	3-lead ECG Cable with leadwires, Snap,IEC	
	U315-33CA	3-lead ECG Cable with leadwires, Clip,AHA	
	U315-33CE	3-lead ECG Cable with leadwires, Clip,IEC	
Siemens (5 pin)			
U315-44SA	U315-44SA	4-lead ECG Cable with leadwires, Snap,AHA	
	U315-44SE	4-lead ECG Cable with leadwires, Snap,IEC	
	U315-44CA	4-lead ECG Cable with leadwires, Clip,AHA	
	U315-44CE	4-lead ECG Cable with leadwires, Clip,IEC	
S&W (Artema) (10 pin)			
8000system, Diascope1,2, Neoscope, DMS700, Defibrillator, Diascope-NT, Athena Systems, Carido-Aid, DS Traveller, DSNT, DS1, DS2, MCX/LS	U332-13SA	3-lead ECG Cable with leadwires, Snap,AHA	
	U332-13SE	3-lead ECG Cable with leadwires, Snap,IEC	
	U332-13CA	3-lead ECG Cable with leadwires, Clip,AHA	
	U332-13CE	3-lead ECG Cable with leadwires, Clip,IEC	
	U332-15SA	5-lead ECG Cable with leadwires, Snap,AHA	
	U332-15CE	5-lead ECG Cable with leadwires, Snap,IEC	
Schiller (12 pin)			
Old type	U325-13SA	3-lead ECG Cable with leadwires, Snap,AHA	
	U355-13SE	3-lead ECG Cable with leadwires, Snap,IEC	
	U325-13CA	3-lead ECG Cable with leadwires, Clip,AHA	
	U325-13CE	3-lead ECG Cable with leadwires, Clip,IEC	
	U325-15SA	5-lead ECG Cable with leadwires, Snap,AHA	
	U325-15CE	5-lead ECG Cable with leadwires, Clip,IEC	

P~Z

Brand/Compatible NO	P/N	Description	Image
Schiller (7 pin)			
U325-23SA	U325-23SA	3-lead ECG Cable with leadwires, Snap,AHA	
	U325-23SE	3-lead ECG Cable with leadwires, Snap,IEC	
	U325-23CA	3-lead ECG Cable with leadwires, Clip,AHA	
	U325-23CE	3-lead ECG Cable with leadwires, Clip,IEC	
	U325-25SA	5-lead ECG Cable with leadwires, Snap,AHA	
	U325-25CE	5-lead ECG Cable with leadwires, Clip,IEC	
Schiller (12 pin)			
Argus LSM	U325-33SA	3-lead ECG Cable with leadwires, Snap,AHA	
	U355-33SE	3-lead ECG Cable with leadwires, Snap,IEC	
	U325-33CA	3-lead ECG Cable with leadwires, Clip,AHA	
	U325-33CE	3-lead ECG Cable with leadwires, Clip,IEC	
	U325-35SA	5-lead ECG Cable with leadwires, Snap,AHA	
	U325-35CE	5-lead ECG Cable with leadwires, Clip,IEC	
Unicare (12 pin)			
U358-23SA	U358-23SA	3-lead ECG Cable with leadwires, Snap,AHA	
	U358-23SE	3-lead ECG Cable with leadwires, Snap,IEC	
	U358-23CA	3-lead ECG Cable with leadwires, Clip,AHA	
	U358-23CE	3-lead ECG Cable with leadwires, Clip,IEC	
	U358-25SA	5-lead ECG Cable with leadwires, Snap,AHA	
	U358-25CE	5-lead ECG Cable with leadwires, Clip,IEC	
WEGO (12 pin)			
U3129-15SA	U3129-15SA	5-lead ECG Cable with leadwires, Snap,AHA	
	U3129-15SE	5-lead ECG Cable with leadwires, Snap,IEC	
	U3129-15CA	5-lead ECG Cable with leadwires, Clip,AHA	
	U3129-15CE	5-lead ECG Cable with leadwires, Clip,IEC	
Welch Allyn (6 pin)			
Propaq 100 series, Propaq 200 series, Propaq Encore, Propaq CS, Ultra Smart, Atlas (1KQ resistor)	U361-13SA	3-lead ECG Cable with leadwires, Snap,AHA	
	U361-13SE	3-lead ECG Cable with leadwires, Snap,IEC	
	U361-13CA	3-lead ECG Cable with leadwires, Clip,AHA	
	U361-13CE	3-lead ECG Cable with leadwires, Clip,IEC	
	U361-15SA	5-lead ECG Cable with leadwires, Snap,AHA	
	U361-15CE	5-lead ECG Cable with leadwires, Clip,IEC	
Welch Allyn (9 pin)			
(1KQ resistor)	U361-23SA	3-lead ECG Cable with leadwires, Snap,AHA	
	U361-23SE	3-lead ECG Cable with leadwires, Snap,IEC	
	U361-23CA	3-lead ECG Cable with leadwires, Clip,AHA	
	U361-23CE	3-lead ECG Cable with leadwires, Clip,IEC	
	U361-25SA	5-lead ECG Cable with leadwires, Snap,AHA	
	U361-25CE	5-lead ECG Cable with leadwires, Clip,IEC	
Zoll (6 pin)			
(1KQ resistor)	U347-13SA	3-lead ECG Cable with leadwires, Snap,AHA	
	U347-13SE	3-lead ECG Cable with leadwires, Snap,IEC	
	U347-13CA	3-lead ECG Cable with leadwires, Clip,AHA	
	U347-13CE	3-lead ECG Cable with leadwires, Clip,IEC	
	U347-15SA	5-lead ECG Cable with leadwires, Snap,AHA	
	U347-15CE	5-lead ECG Cable with leadwires, Clip,IEC	
Zoncare (6 pin)			
Zoncare	U399-13SA	3-lead ECG Cable with leadwires, Snap,AHA	
	U399-13SE	3-lead ECG Cable with leadwires, Snap,IEC	
	U399-13CA	3-lead ECG Cable with leadwires, Clip,AHA	
	U399-13CE	3-lead ECG Cable with leadwires, Clip,IEC	
	U399-15SA	5-lead ECG Cable with leadwires, Snap,AHA	
	U399-15CE	5-lead ECG Cable with leadwires, Clip,IEC	

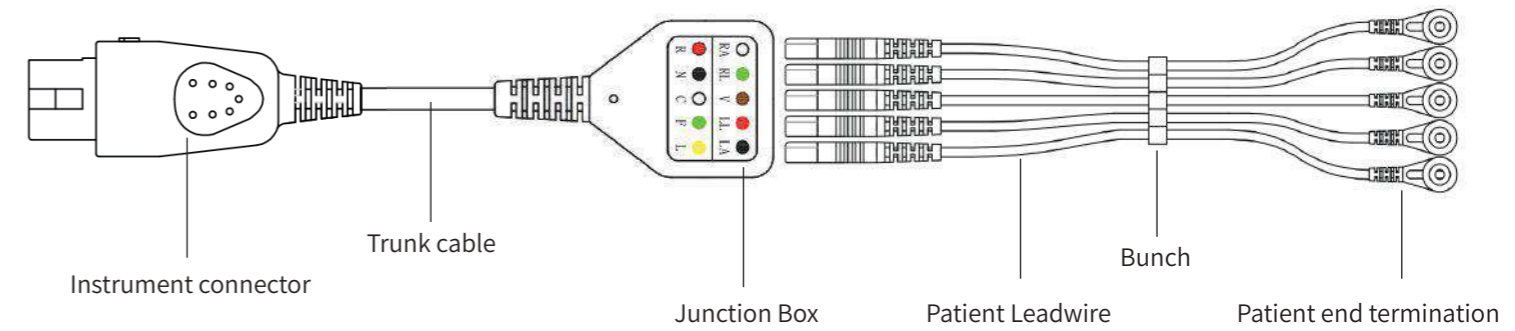

CONNECTOR TYPE



SEPERATED ECG TYPE

	A		A		B		B		C		C
	A		A		B		B		C		C
	D		D		J		J		G		G
	D		D		R		R		N		N
	H		H		P		P		E		E
	H		H		P		P		S		S
	K		K		P		P		P		P

Brand/Compatible NO	P/N	Description	Image
Normal ECG Cable (6 pin)			
Abbott Medical: EX-50, Lifecare 5100, Lifecare 5200; Advanced Instrumentations: PM-1000, PM-1000EX; Air Shields: HRRM-71-1/2, Porta-Fib I, II, III, System5, System6; ALT: 800, 800Plus, CX ATL Ultrasound, CX200, CX400, Apogee, HDI 9/200, Interspec Cardiology XL, Mark IV, Mark VII, Ultramark 4/5/7/B; Analogic: Lifegard II (Requires cable with resistance); BCI Biochem International (Smiths Medical): 3101, 3404, 6100, 6200, 9100, 9200, Advisor, Autocorr, Surgivet, Cardell 9403V, 9405, Max-1; Carewell CPM-8000; Colin: BP308, BP408, CBM3000; Criticare: 504US, 504USP, 506, 507, 507E, 507ELC2, 507S, 508, 602-4B, 602-4USP, 1100, 2200, Poet 2, Scholar, nCompass, nGenuity 8100E, 8100E; Digicare LW600; Draeger Vitalert 2000, Vitalert 3000, Edar: M8, M8A, M8B, M9, M9A, M50, M80; GE®: Corometrics 556, Critikon 8100T, Dinamap 8700/9700, Critikon Dinamap MPS, Select, Dinamap Pro 1000; Guthart 1000; Infinium Medical: Infliron II; IVY Biomedical: 101 (before 1989), 402, 700; LSI: LS5, 261, MDE: Escort 100, 101, 102, 200, 300, Prism, 360SL, 450SL, 521A, PortaPak 80, PortaPak 90/100; Mindray: MEC 200, MEC 1000, MEC 1200, MEC 2000; Ohmeda: enGuard CMS; Physio Control (Medtronic): Lifepak 5, Lifepak 6, Lifepak 6S, Lifepak 7, Lifepak 8, Lifepak 9, Lifepak 10, Physio 1440R, VSM-1ESF, VSM-2, VSM-2ESF, VSM-3; Nellcor: N-200, N-250, C-LOCK, N-1000, NPB-3900, NPB-4000; Nihon Kohden: BSM-8301A, 8302A, 8500A, 8502A, OEC-6102A (s/n>20156), 7102A, 8106A, OEC-6105A (s/n>20226), TEC 5531E, TEC-7100A, TEC-5200A (s/n>20421), TEC-7200A, 7300A; Novametric 902, 903, 910, Life Defense 1; Pace Tech: Neonatepack 300, Neonatepack 3000/3100, NeonateMax 4000CL, Vitaimax 800 Plus, 2100, 2200, 4000, 4100, Vitaimax 4000CL, 4000, Modular4100CL; Palco: Philips: IE33 Matrix Ultrasound CX50, M3921A A1, M3923A A1, M3925A A1, M3927A A3, M3929A A3; Pioneer (American Optical): 26125, 33167, 5260, 5330, Pulsar 4; PPG (Datamedix, Becton-Dickinson): Guardian 1001, N1001; Siemens: Sirecust 300DU, Sirecust 610, Sirecust 630, Sirecust DU, Cypress Ultrasound, Acuson CV70, Acuson C256, Acuson Sequoia 512; Spacelabs Burdick: Medic 3, Medic 4, Medic 5, Medic 6, Series 500, Series 600, Series 900, 90300, 90303, 90303B, 90400, 90600, 90603A, 90700 Series, TEK-208408/511/512/514/521, PCMS, 067112; Tektronik (Vitek): 4045; Defib/208/400/500 Series; Welch Allyn: Propaq 100, Propaq 200 Series, Atlas Propaq Encore, Propaq CS, Ultra Smart, PIC 30, PIC 40, PIC 50; Zoll: M Series, E Series R Series, PD1200, PD1400, PD1600, PD1700, D900, PD2000; OEM: 8000-0025, 9500-0229	U301-12A3AE	Din 3-lead Trunk Cable,AHA / IEC	
	U301-12A5AE	Din 5-lead Trunk Cable,AHA / IEC	
	U301-12B3AE	LL 3-lead Trunk Cable,AHA / IEC	
	U301-12B5AE	LL 5-lead Trunk Cable,AHA / IEC	
	U301-12C3A	ASP 3-lead Trunk Cable,AHA	
	U301-12C3E	ASP 3-lead Trunk Cable,IEC	
	U301-12C5A	ASP 5-lead Trunk Cable,AHA	
	U301-12C5E	ASP 5-lead Trunk Cable,IEC	
	U301-12D3A	Euro 3-lead Trunk Cable,AHA	
	U301-12D5E	Euro 5-lead Trunk Cable,IEC	
Biolight (12 pin)			
A series:A3,A5,A6,A8	U309-12B3AE	LL 3-lead Trunk Cable,AHA / IEC	
	U309-12B5AE	LL 5-lead Trunk Cable,AHA / IEC	
	U309-12C3A	ASP 3-lead Trunk Cable,AHA	
	U309-12C3E	ASP 3-lead Trunk Cable,IEC	
	U309-12C5A	ASP 5-lead Trunk Cable,AHA	
	U309-12C5E	ASP 5-lead Trunk Cable,IEC	
	U309-12D3A	Euro 3-lead Trunk Cable,AHA	
	U309-12D3E	Euro 3-lead Trunk Cable,IEC	
	U309-12D5A	Euro 5-lead Trunk Cable,AHA	
	U309-12D5E	Euro 5-lead Trunk Cable,IEC	
Biolight (12 pin)			
M series: M7000,M8000,M9000,M9500	U309-22A3AE	Din 3-lead Trunk Cable,AHA / IEC	
	U309-22A5AE	Din 5-lead Trunk Cable,AHA / IEC	
	U309-22B3AE	LL 3-lead Trunk Cable,AHA / IEC	
	U309-22B5AE	LL 5-lead Trunk Cable,AHA / IEC	
	U309-22C3A	ASP 3-lead Trunk Cable,AHA	
	U309-22C3E	ASP 3-lead Trunk Cable,IEC	
	U309-22C5A	ASP 5-lead Trunk Cable,AHA	
	U309-22C5E	ASP 5-lead Trunk Cable,IEC	
	U309-22D3A	Euro 3-lead Trunk Cable,AHA	
	U309-22D5A	Euro 5-lead Trunk Cable,AHA	
Bionet (8 pin)			
BM3	U323-12A3AE	Din 3-lead Trunk Cable,AHA / IEC	
	U323-12A5AE	Din 5-lead Trunk Cable,AHA / IEC	
	U323-12B3AE	LL 3-lead Trunk Cable,AHA / IEC	
	U323-12B5AE	LL 5-lead Trunk Cable,AHA / IEC	
	U323-12C3A	ASP 3-lead Trunk Cable,AHA	
	U323-12C3E	ASP 3-lead Trunk Cable,IEC	
	U323-12C5A	ASP 5-lead Trunk Cable,AHA	
	U323-12C5E	ASP 5-lead Trunk Cable,IEC	
	U323-12D3A	Euro 3-lead Trunk Cable,AHA	
	U323-12D5E	Euro 5-lead Trunk Cable,IEC	
Bionet (12 pin)			
SM784,SM785	U324-12A3AE	Din 3-lead Trunk Cable,AHA / IEC	
	U324-12A5AE	Din 5-lead Trunk Cable,AHA / IEC	
	U324-12B3AE	LL 3-lead Trunk Cable,AHA / IEC	
	U324-12B5AE	LL 5-lead Trunk Cable,AHA / IEC	
	U324-12C3A	ASP 3-lead Trunk Cable,AHA	
	U324-12C3E	ASP 3-lead Trunk Cable,IEC	
	U324-12C5A	ASP 5-lead Trunk Cable,AHA	
	U324-12C5E	ASP 5-lead Trunk Cable,IEC	
	U324-12D3A	Euro 3-lead Trunk Cable,AHA	
	U324-12D5E	Euro 5-lead Trunk Cable,IEC	
Criticare/CSI (6 pin)			
2000,2001,2002,2100,2200,3000,3000A,Ballo Pump, M/D3 W/lead select,M/D3A, M/D4,Passport,Passport IL, Passport XG,Passport XL, Passport2,Passport 2LT, Spectrum system 90,system 90T,system 96,system 97	U312-12A3AE	Din 3-lead Trunk Cable,AHA / IEC	
	U312-12A5AE	Din 5-lead Trunk Cable,AHA / IEC	
	U312-12B3AE	LL 3-lead Trunk Cable,AHA / IEC	
	U312-12B5AE	LL 5-lead Trunk Cable,AHA / IEC	
	U312-12C3A	ASP 3-lead Trunk Cable,AHA	
	U312-12C3E	ASP 3-lead Trunk Cable,IEC	
	U312-12C5A	ASP 5-lead Trunk Cable,AHA	
	U312-12C5E	ASP 5-lead Trunk Cable,IEC	
	U312-12D3A	Euro 3-lead Trunk Cable,AHA	
	U312-12D5E	Euro 5-lead Trunk Cable,IEC	

Brand/Compatible NO	P/N	Description	Image
Biolight (12 pin)			
A series:A3,A5,A6,A8	U309-12B3AE	LL 3-lead Trunk Cable,AHA / IEC	
	U309-12B5AE	LL 5-lead Trunk Cable,AHA / IEC	
	U309-12C3A	ASP 3-lead Trunk Cable,AHA	
	U309-12C3E	ASP 3-lead Trunk Cable,IEC	
	U309-12C5A	ASP 5-lead Trunk Cable,AHA	
	U309-12C5E	ASP 5-lead Trunk Cable,IEC	
	U309-12D3A	Euro 3-lead Trunk Cable,AHA	
	U309-12D3E	Euro 3-lead Trunk Cable,IEC	
	U309-12D5A	Euro 5-lead Trunk Cable,AHA	
	U309-12D5E	Euro 5-lead Trunk Cable,IEC	
Biolight (12 pin)			
M series: M7000,M8000,M9000,M9500	U309-22A3AE	Din 3-lead Trunk Cable,AHA / IEC	
	U309-22A5AE	Din 5-lead Trunk Cable,AHA / IEC	
	U309-22B3AE	LL 3-lead Trunk Cable,AHA / IEC	
	U309-22B5AE	LL 5-lead Trunk Cable,AHA / IEC	
	U309-22C3A	ASP 3-lead Trunk Cable,AHA	
	U309-22C3E	ASP 3-lead Trunk Cable,IEC	
	U309-22C5A	ASP 5-lead Trunk Cable,AHA	
	U309-22C5E	ASP 5-lead Trunk Cable,IEC	
	U309-22D3A	Euro 3-lead Trunk Cable,AHA	
	U309-22D5A	Euro 5-lead Trunk Cable,AHA	
Bionet (8 pin)			
BM3	U323-12A3AE	Din 3-lead Trunk Cable,AHA / IEC	
	U323-12A5AE	Din 5-lead Trunk Cable,AHA / IEC	
	U323-12B3AE	LL 3-lead Trunk Cable,AHA / IEC	
	U323-12B5AE	LL 5-lead Trunk Cable,AHA / IEC	
	U323-12C3A	ASP 3-lead Trunk Cable,AHA	
	U323-12C3E	ASP 3-lead Trunk Cable,IEC	
	U323-12C5A	ASP 5-lead Trunk Cable,AHA	
	U323-12C5E	ASP 5-lead Trunk Cable,IEC	
	U323-12D3A	Euro 3-lead Trunk Cable,AHA	
	U323-12D5E	Euro 5-lead Trunk Cable,IEC	

Brand/Compatible NO	P/N	Description	Image	
Bionet (8 pin)				
BM3	U323-12C5A	ASP 5-lead Trunk Cable,AHA		
	U323-12C5E	ASP 5-lead Trunk Cable,IEC		
	U323-12D3A	Euro 3-lead Trunk Cable,AHA		
	U323-12D3E	Euro 3-lead Trunk Cable,IEC		
	U323-12D5A	Euro 5-lead Trunk Cable,AHA		
	U323-12D5E	Euro 5-lead Trunk Cable,IEC		
	Bionet (12 pin)			
		U323-22A5AE	Din 5-lead Trunk Cable,AHA / IEC	
		U323-22B5AE	LL 5-lead Trunk Cable,AHA / IEC	
		U323-22C5A	ASP 5-lead Trunk Cable,AHA	
U323-22C5E		ASP 5-lead Trunk Cable,IEC		
U323-22D5A		Euro 5-lead Trunk Cable,AHA		
U323-22D5E		Euro 5-lead Trunk Cable,IEC		
Braker (12 pin)				
		U324-12A3AE	Din 3-lead Trunk Cable,AHA / IEC	
		U324-12A5AE	Din 5-lead Trunk Cable,AHA / IEC	
		U324-12B3AE	LL 3-lead Trunk Cable,AHA / IEC	
	U324-12B5AE	LL 5-lead Trunk Cable,AHA / IEC		
	U324-12C3A	ASP 3-lead Trunk Cable,AHA		
	U324-12C3E	ASP 3-lead Trunk Cable,IEC		
	U324-12C5A	ASP 5-lead Trunk Cable,AHA		
	U324-12C5E	ASP 5-lead Trunk Cable,IEC		
	U324-12D3A	Euro 3-lead Trunk Cable,AHA		
	U324-12D5E	Euro 5-lead Trunk Cable,IEC		
Criticare/CSI (6 pin)				
2000,2001,2002,2100,2200,3000,3000A,Ballo Pump, M/D3 W/lead select,M/D3A, M/D4,Passport,Passport IL, Passport XG,Passport XL, Passport2,Passport 2LT, Spectrum system 90,system 90T,system 96,system 97	U314-12A3AE	Din 3-lead Trunk Cable,AHA / IEC		
	U312-12A5AE	Din 5-lead Trunk Cable,AHA / IEC		
	U312-12B3AE	LL 3-lead Trunk Cable,AHA / IEC		
	U312-12B5AE	LL 5-lead Trunk Cable,AHA / IEC		

Brand/Compatible NO	P/N	Description	Image	
Criticare/CSI (6 pin)				
2000,2001,2002,2100,2200,3000,3000A,Ballo Pump, M/D3 W/lead select,M/D3A, M/D4,Passport,Passport IL, Passport XG,Passport XL, Passport2,Passport 2LT, Spectrum system 90,system 90T,system 96,system 97	U312-12C3A	ASP 3-lead Trunk Cable,AHA		
	U312-12C3E	ASP 3-lead Trunk Cable,IEC		
	U312-12C5A	ASP 5-lead Trunk Cable,AHA		
	U312-12C5E	ASP 5-lead Trunk Cable,IEC		
	U312-12D3A	Euro 3-lead Trunk Cable,AHA		
	U312-12D3E	Euro 3-lead Trunk Cable,IEC		
	U312-12D5A	Euro 5-lead Trunk Cable,AHA		
	U312-12D5E	Euro 5-lead Trunk Cable,IEC		
	Creative (6 pin)			
	PC9000S,PC9000,UP6000	U310-12A3AE	Din 3-lead Trunk Cable,AHA / IEC	
U310-12A5AE		Din 5-lead Trunk Cable,AHA / IEC		
U310-12B3AE		LL 3-lead Trunk Cable,AHA / IEC		
U310-12B5AE		LL 5-lead Trunk Cable,AHA / IEC		
U310-12C3A		ASP 3-lead Trunk Cable,AHA		
U310-12C3E		ASP 3-lead Trunk Cable,IEC		
U310-12C5A		ASP 5-lead Trunk Cable,AHA		
U310-12C5E		ASP 5-lead Trunk Cable,IEC		
U310-12D3A		Euro 3-lead Trunk Cable,AHA		
U310-12D5E		Euro 5-lead Trunk Cable,IEC		
Colin (6 pin)				
BP88/BP306	U341-12J5A	5-lead Trunk Cable,AHA		
	U341-12J5E	5-lead Trunk Cable,IEC		
BP88S,Colin Press Mate Advantage, Omron BP-S510	U341-22J5A	5-lead Trunk Cable,AHA		
	U341-22J5E	5-lead Trunk Cable,IEC		
Comen (12 pin)				
C30,C50,C60,C70, Comen®000E, Star8000, Comen NC10	U338-12A3AE	Din 3-lead Trunk Cable,AHA / IEC		
	U338-12A5AE	Din 5-lead Trunk Cable,AHA / IEC		
	U338-12B3AE	LL 3-lead Trunk Cable,AHA / IEC		
	U338-12B5AE	LL 5-lead Trunk Cable,AHA / IEC		
	U338-12C3A	ASP 3-lead Trunk Cable,AHA		
	U338-12C3E	ASP 3-lead Trunk Cable,IEC		

Brand/Compatible NO	P/N	Description	Image	
Comen (12 pin)				
C30, C50, C60, C70, Comen8000E, Star8000, Comen NC10	U338-12C5A	ASP 5-lead Trunk Cable,AHA		
	U338-12C5E	ASP 5-lead Trunk Cable,IEC		
	U338-12D3A	Euro 3-lead Trunk Cable,AHA		
	U338-12D3E	Euro 3-lead Trunk Cable,IEC		
	U338-12D5A	Euro 5-lead Trunk Cable,AHA		
	U338-12D5E	Euro 5-lead Trunk Cable,IEC		
Datscope (6 pin)				
2000,2001,2002,2100,2200, 3000,3000A,Ballo Pump,M/D3 W/lead select,M/D3A,M/D4, Passport,PassportIL, Passport XG Passport XL,Passport2, Passport 2LT, Spectrum system 90, system 90T,system 96, system 97	U314-12A3AE	Din 3-lead Trunk Cable,AHA / IEC		
	U314-12A5AE	Din 5-lead Trunk Cable,AHA / IEC		
	U314-12B3AE	LL 3-lead Trunk Cable,AHA / IEC		
	U314-12B5AE	LL 5-lead Trunk Cable,AHA / IEC		
	U314-12C3A	ASP 3-lead Trunk Cable,AHA		
	U314-12C3E	ASP 3-lead Trunk Cable,IEC		
	U314-12C5A	ASP 5-lead Trunk Cable,AHA		
	U314-12C5E	ASP 5-lead Trunk Cable,IEC		
	U314-12D3A	Euro 3-lead Trunk Cable,AHA		
	U314-12D3E	Euro 3-lead Trunk Cable,IEC		
	U314-12D5A	Euro 5-lead Trunk Cable,AHA		
	U314-12D5E	Euro 5-lead Trunk Cable,IEC		
	Datscope (12 pin)			
		U314-22R5AE	Datscope 5-lead Trunk Cable,AHA / IEC	
	Datex (10 pin)			
	AS/3, CS/3, S/5, Cardiocap 1, Cardiocap 2, Cardiocap 5, Light Monitor,Satelliteplus AS/3 Compact,S/5 Compact Light Monitor, Satellite Plus S5, Aespire	U306-12A3AE	Din 3-lead Trunk Cable,AHA / IEC	
		U306-12A5AE	Din 5-lead Trunk Cable,AHA / IEC	
U306-12B3AE		LL 3-lead Trunk Cable,AHA / IEC		
U306-12B5AE		LL 5-lead Trunk Cable,AHA / IEC		
U306-12C3A		ASP 3-lead Trunk Cable,AHA		
U306-12C3E		ASP 3-lead Trunk Cable,IEC		
U306-12C5A		ASP 5-lead Trunk Cable,AHA		
U306-12C5E		ASP 5-lead Trunk Cable,IEC		
U306-12D3A		Euro 3-lead Trunk Cable,AHA		
U306-12D3E		Euro 3-lead Trunk Cable,IEC		
U306-12D5A		Euro 5-lead Trunk Cable,AHA		
U306-12D5E		Euro 5-lead Trunk Cable,IEC		

Brand/Compatible NO	P/N	Description	Image	
Datex (10 pin)				
AS/3, CS/3, S/5, Cardiocap 1, Cardiocap 2, Cardiocap 5, Light Monitor,Satelliteplus AS/3 Compact,S/5 Compact Light Monitor, Satellite Plus S5, Aespire	U306-12D5A	Euro 5-lead Trunk Cable,AHA		
	U306-12D5E	Euro 5-lead Trunk Cable,IEC		
Dixtal (6 pin)				
DX405, DX2010, DX2020, DX2021, DX2405, DX2515 (1KΩ resistor)	U395-12A3AE	Din 3-lead Trunk Cable,AHA / IEC		
	U395-12A5AE	Din 5-lead Trunk Cable,AHA / IEC		
	U395-12B3AE	LL 3-lead Trunk Cable,AHA / IEC		
	U395-12B5AE	LL 5-lead Trunk Cable,AHA / IEC		
	U395-12C3A	ASP 3-lead Trunk Cable,AHA		
	U395-12C3E	ASP 3-lead Trunk Cable,IEC		
	U395-12C5A	ASP 5-lead Trunk Cable,AHA		
	U395-12C5E	ASP 5-lead Trunk Cable,IEC		
	U395-12D3A	Euro 3-lead Trunk Cable,AHA		
	U395-12D3E	Euro 3-lead Trunk Cable,IEC		
	U395-12D5A	Euro 5-lead Trunk Cable,AHA		
	U395-12D5E	Euro 5-lead Trunk Cable,IEC		
	Edan (6 pin)			
	DS-7100	U372-12A3AE	Din 3-lead Trunk Cable,AHA / IEC	
		U372-12A5AE	Din 5-lead Trunk Cable,AHA / IEC	
U372-12B3AE		LL 3-lead Trunk Cable,AHA / IEC		
U372-12B5AE		LL 5-lead Trunk Cable,AHA / IEC		
U372-12C3A		ASP 3-lead Trunk Cable,AHA		
U372-12C3E		ASP 3-lead Trunk Cable,IEC		
U372-12C5A		ASP 5-lead Trunk Cable,AHA		
U372-12C5E		ASP 5-lead Trunk Cable,IEC		
U372-12D3A		Euro 3-lead Trunk Cable,AHA		
U372-12D3E		Euro 3-lead Trunk Cable,IEC		
U372-12D5A		Euro 5-lead Trunk Cable,AHA		
U372-12D5E		Euro 5-lead Trunk Cable,IEC		
Fukuda Denshi (12 pin)				
DS-7100		U369-12A5AE	Din 5-lead Trunk Cable,AHA / IEC	
		U369-12B5AE	LL 5-lead Trunk Cable,AHA / IEC	

Brand/Compatible NO	P/N	Description	Image	
Fukuda Denshi (12 pin)				
DS-7100	U369-12C5A	ASP 5-lead Trunk Cable,AHA		
	U369-12C5E	ASP 5-lead Trunk Cable,IEC		
	U369-12D5A	Euro 5-lead Trunk Cable,AHA		
	U369-12D5E	Euro 5-lead Trunk Cable,IEC		
Fukuda Denshi (12 pin)				
Mindray Datscope Expert and Fukuda Denshi Dynascope DS-5100, DS-5100E, DS-5300W, DS-5400, DS-7001	U369-22A3AE	Din 3-lead Trunk Cable,AHA / IEC		
	U369-22A5AE	Din 5-lead Trunk Cable,AHA / IEC		
	U369-22B3AE	LL 3-lead Trunk Cable,AHA / IEC		
	U369-22B5AE	LL 5-lead Trunk Cable,AHA / IEC		
	U369-22C3A	ASP 3-lead Trunk Cable,AHA		
	U369-22C3E	ASP 3-lead Trunk Cable,IEC		
	U369-22C5A	ASP 5-lead Trunk Cable,AHA		
	U369-22C5E	ASP 5-lead Trunk Cable,IEC		
	U369-22D3A	Euro 3-lead Trunk Cable,AHA		
	U369-22D3E	Euro 3-lead Trunk Cable,IEC		
	U369-22D5A	Euro 5-lead Trunk Cable,AHA		
	U369-22D5E	Euro 5-lead Trunk Cable,IEC		
	GE (6 pin)			
	(1KΩ resistor)	U302-12A3AE	Din 3-lead Trunk Cable,AHA / IEC	
		U302-12A5AE	Din 5-lead Trunk Cable,AHA / IEC	
		U302-12B3AE	LL 3-lead Trunk Cable,AHA / IEC	
		U302-12B5AE	LL 5-lead Trunk Cable,AHA / IEC	
U302-12C3A		ASP 3-lead Trunk Cable,AHA		
U302-12C3E		ASP 3-lead Trunk Cable,IEC		
U302-12C5A		ASP 5-lead Trunk Cable,AHA		
U302-12C5E		ASP 5-lead Trunk Cable,IEC		
U302-12D3A		Euro 3-lead Trunk Cable,AHA		
U302-12D3E		Euro 3-lead Trunk Cable,IEC		
U302-12D5A		Euro 5-lead Trunk Cable,AHA		
U302-12D5E		Euro 5-lead Trunk Cable,IEC		
GE (11 pin)				
		U302-22A3AE	Din 3-lead Trunk Cable,AHA / IEC	

Brand/Compatible NO	P/N	Description	Image
GE (11 pin)			
GEMS:Dash PRO 4000, Dash PRO 3000, Dash PRO 2000, Dash 1000, Eagle Systems, MAC-Lab, Solar 9500, Solar 8000, Solar 3000, Tram 100, Tram 200, Tram 300, Tram 400, Tram 500, Tram 600, Tram 800, Unity systems	U302-22A5AE	Din 5-lead Trunk Cable,AHA / IEC	
	U302-22B3AE	LL 3-lead Trunk Cable,AHA / IEC	
	U302-22B5AE	LL 5-lead Trunk Cable,AHA / IEC	
	U302-22G5A	GE 3/5-lead Trunk Cable,AHA	
	U302-22G5E	GE 3/5-lead Trunk Cable,IEC	
	U302-22C3A	ASP 3-lead Trunk Cable,AHA	
	U302-22C3E	ASP 3-lead Trunk Cable,IEC	
	U302-22C5A	ASP 5-lead Trunk Cable,AHA	
	U302-22C5E	ASP 5-lead Trunk Cable,IEC	
	U302-22D3A	Euro 3-lead Trunk Cable,AHA	
	U302-22D3E	Euro 3-lead Trunk Cable,IEC	
	U302-22D5A	Euro 5-lead Trunk Cable,AHA	
U302-22D5E	Euro 5-lead Trunk Cable,IEC		
GMI(NEWTECH) (6 pin)			
	U340-22A3AE	Din 3-lead Trunk Cable,AHA / IEC	
	U340-22A5AE	Din 5-lead Trunk Cable,AHA / IEC	
Heyer/Saadat (8 pin)			
VizOR, VizOR12	U3112-12A3AE	Din 3-lead Trunk Cable,AHA / IEC	
	U3112-12A5AE	Din 5-lead Trunk Cable,AHA / IEC	
	U3112-12B3AE	LL 3-lead Trunk Cable,AHA / IEC	
	U3112-12B5AE	LL 5-lead Trunk Cable,AHA / IEC	
	U3112-12C3A	ASP 3-lead Trunk Cable,AHA	
	U3112-12C3E	ASP 3-lead Trunk Cable,IEC	
	U3112-12C5A	ASP 5-lead Trunk Cable,AHA	
	U3112-12C5E	ASP 5-lead Trunk Cable,IEC	
	U3112-12D3A	Euro 3-lead Trunk Cable,AHA	
	U3112-12D3E	Euro 3-lead Trunk Cable,IEC	
	U3112-12D5A	Euro 5-lead Trunk Cable,AHA	
	U3112-12D5E	Euro 5-lead Trunk Cable,IEC	
Hellige (10 pin)			
	U327-22A3AE	Din 3-lead Trunk Cable,AHA / IEC	

C~F

F~H

Brand/Compatible NO	P/N	Description	Image				
Hellige (10 pin)							
Hellige, Servomed 4, Generation, SCP 851, SCP 852, SCP 844, SCS 804, Cardioserv, VICO-com-sm, Eagle 1000 Def, SCP900, SMC, SMS, SMK, SMU, SMV	U327-22A5AE	Din 5-lead Trunk Cable, AHA / IEC					
	U327-22B3AE	LL 3-lead Trunk Cable, AHA / IEC					
	U327-22B5AE	LL 5-lead Trunk Cable, AHA / IEC					
	U327-22C3A	ASP 3-lead Trunk Cable, AHA					
	U327-22C3E	ASP 3-lead Trunk Cable, IEC					
	U327-22C5A	ASP 5-lead Trunk Cable, AHA					
	U327-22C5E	ASP 5-lead Trunk Cable, IEC					
	U327-22D3A	Euro 3-lead Trunk Cable, AHA					
	U327-22D3E	Euro 3-lead Trunk Cable, IEC					
	U327-22D5A	Euro 5-lead Trunk Cable, AHA					
	U327-22D5E	Euro 5-lead Trunk Cable, IEC					
	Huntleigh (8 pin)						
	Huntleigh	U377-12A3AE	Din 3-lead Trunk Cable, AHA / IEC				
U377-12A5AE		Din 5-lead Trunk Cable, AHA / IEC					
U377-12B3AE		LL 3-lead Trunk Cable, AHA / IEC					
U377-12B5AE		LL 5-lead Trunk Cable, AHA / IEC					
U377-12C3A		ASP 3-lead Trunk Cable, AHA					
U377-12C3E		ASP 3-lead Trunk Cable, IEC					
U377-12C5A		ASP 5-lead Trunk Cable, AHA					
U377-12C5E		ASP 5-lead Trunk Cable, IEC					
U377-12D3A		Euro 3-lead Trunk Cable, AHA					
U377-12D3E		Euro 3-lead Trunk Cable, IEC					
U377-12D5A		Euro 5-lead Trunk Cable, AHA					
U377-12D5E		Euro 5-lead Trunk Cable, IEC					
Infinium (6 pin)							
(1KΩ resistor)	U367-12A3AE	Din 3-lead Trunk Cable, AHA / IEC					
	U367-12A5AE	Din 5-lead Trunk Cable, AHA / IEC					
	U367-12B3AE	LL 3-lead Trunk Cable, AHA / IEC					
	U367-12B5AE	LL 5-lead Trunk Cable, AHA / IEC					
U367-22C3A	ASP 3-lead Trunk Cable, AHA						
U367-22C3E	ASP 3-lead Trunk Cable, IEC						
U367-22C5A	ASP 5-lead Trunk Cable, AHA						
U367-22C5E	ASP 5-lead Trunk Cable, IEC						
U367-22D3A	Euro 3-lead Trunk Cable, AHA						
U367-22D3E	Euro 3-lead Trunk Cable, IEC						
U367-22D5A	Euro 5-lead Trunk Cable, AHA						
U367-22D5E	Euro 5-lead Trunk Cable, IEC						
Infinium (12 pin)							
U367-32A3AE	Din 3-lead Trunk Cable, AHA / IEC						
	U367-32B3AE	LL 3-lead Trunk Cable, AHA / IEC					
		U367-32C3A	ASP 3-lead Trunk Cable, AHA				
			U367-32C3E	ASP 3-lead Trunk Cable, IEC			
				U367-32D3A	Euro 3-lead Trunk Cable, AHA		
					U367-32D3E	Euro 3-lead Trunk Cable, IEC	
Kontron (12 pin)							
U329-12A3AE	Din 3-lead Trunk Cable, AHA / IEC						
	U329-12A5AE	Din 5-lead Trunk Cable, AHA / IEC					
		U329-12B3AE	LL 3-lead Trunk Cable, AHA / IEC				

Brand/Compatible NO	P/N	Description	Image										
Infinium (6 pin)													
(1KΩ resistor)	U367-12C3A	ASP 3-lead Trunk Cable, AHA											
	U367-12C3E	ASP 3-lead Trunk Cable, IEC											
	U367-12C5A	ASP 5-lead Trunk Cable, AHA											
	U367-12C5E	ASP 5-lead Trunk Cable, IEC											
	U367-12D3A	Euro 3-lead Trunk Cable, AHA											
	U367-12D3E	Euro 3-lead Trunk Cable, IEC											
	U367-12D5A	Euro 5-lead Trunk Cable, AHA											
	U367-12D5E	Euro 5-lead Trunk Cable, IEC											
Infinium (12 pin)													
U367-22A3AE	Din 3-lead Trunk Cable, AHA / IEC												
	U367-22A5AE	Din 5-lead Trunk Cable, AHA / IEC											
		U367-22B3AE	LL 3-lead Trunk Cable, AHA / IEC										
			U367-22B5AE	LL 5-lead Trunk Cable, AHA / IEC									
				U367-22C3A	ASP 3-lead Trunk Cable, AHA								
					U367-22C3E	ASP 3-lead Trunk Cable, IEC							
						U367-22C5A	ASP 5-lead Trunk Cable, AHA						
							U367-22C5E	ASP 5-lead Trunk Cable, IEC					
								U367-22D3A	Euro 3-lead Trunk Cable, AHA				
									U367-22D3E	Euro 3-lead Trunk Cable, IEC			
										U367-22D5A	Euro 5-lead Trunk Cable, AHA		
											U367-22D5E	Euro 5-lead Trunk Cable, IEC	
Infinium (12 pin)													
U367-32A3AE	Din 3-lead Trunk Cable, AHA / IEC												
	U367-32B3AE	LL 3-lead Trunk Cable, AHA / IEC											
		U367-32C3A	ASP 3-lead Trunk Cable, AHA										
			U367-32C3E	ASP 3-lead Trunk Cable, IEC									
				U367-32D3A	Euro 3-lead Trunk Cable, AHA								
					U367-32D3E	Euro 3-lead Trunk Cable, IEC							
Kontron (12 pin)													
U329-12A3AE	Din 3-lead Trunk Cable, AHA / IEC												
	U329-12A5AE	Din 5-lead Trunk Cable, AHA / IEC											
		U329-12B3AE	LL 3-lead Trunk Cable, AHA / IEC										

Brand/Compatible NO	P/N	Description	Image	
Kontron (12 pin)				
7000, 7135, 7135B, 7141, 7210, 7250, 7251, K2000, KAAAT, Kolomon, Micromon, Neonatemon, Supermon, Vitalmon	U329-12B5AE	LL 5-lead Trunk Cable, AHA / IEC		
	U329-12C3A	ASP 3-lead Trunk Cable, AHA		
	U329-12C3E	ASP 3-lead Trunk Cable, IEC		
	U329-12C5A	ASP 5-lead Trunk Cable, AHA		
	U329-12C5E	ASP 5-lead Trunk Cable, IEC		
	U329-12D3A	Euro 3-lead Trunk Cable, AHA		
	U329-12D3E	Euro 3-lead Trunk Cable, IEC		
	U329-12D5A	Euro 5-lead Trunk Cable, AHA		
	U329-12D5E	Euro 5-lead Trunk Cable, IEC		
	Mindray/Goldway (6 pin)			
	PM7000, PM8000, PM9000, UT4000A, UT4000A Pro, UT5000A, UT4000B, UT4000C, UT4000F, UT6000F, UT4000F PRO, UT4800	U303-12A3AE	Din 3-lead Trunk Cable, AHA / IEC	
		U303-12A5AE	Din 5-lead Trunk Cable, AHA / IEC	
U303-12B3AE		LL 3-lead Trunk Cable, AHA / IEC		
U303-12B5AE		LL 5-lead Trunk Cable, AHA / IEC		
U303-12C3A		ASP 3-lead Trunk Cable, AHA		
U303-12C3E		ASP 3-lead Trunk Cable, IEC		
U303-12C5A		ASP 5-lead Trunk Cable, AHA		
U303-12C5E		ASP 5-lead Trunk Cable, IEC		
U303-12D3A		Euro 3-lead Trunk Cable, AHA		
U303-12D3E		Euro 3-lead Trunk Cable, IEC		
U303-12D5A		Euro 5-lead Trunk Cable, AHA		
U303-12D5E		Euro 5-lead Trunk Cable, IEC		
Mindray (12 pin)				
PM5000, PM6000		U303-22A3AE	Din 3-lead Trunk Cable, AHA / IEC	
	U303-22A5AE	Din 5-lead Trunk Cable, AHA / IEC		
	U303-22B3AE	LL 3-lead Trunk Cable, AHA / IEC		
	U303-22B5AE	LL 5-lead Trunk Cable, AHA / IEC		
	U303-22C3A	ASP 3-lead Trunk Cable, AHA		
	U303-22C3E	ASP 3-lead Trunk Cable, IEC		
	U303-22C5A	ASP 5-lead Trunk Cable, AHA		
	U303-22C5E	ASP 5-lead Trunk Cable, IEC		
	U303-22D3A	Euro 3-lead Trunk Cable, AHA		

Brand/Compatible NO	P/N	Description	Image	
Mindray (12 pin)				
PM5000, PM6000	U303-22D3A	Euro 3-lead Trunk Cable, AHA		
	U303-22D3E	Euro 3-lead Trunk Cable, IEC		
	U303-22D5A	Euro 5-lead Trunk Cable, AHA		
	U303-22D5E	Euro 5-lead Trunk Cable, IEC		
Mindray T5 (12 pin)				
BeneView T5, T6, T8, IPM, IMEC series monitors, BeneHeart defibrillator. (1KΩ resistor)	U303-32A3AE	Din 3-lead Trunk Cable, AHA / IEC		
	U303-32A5AE	Din 5-lead Trunk Cable, AHA / IEC		
	U303-32B3AE	LL 3-lead Trunk Cable, AHA / IEC		
	U303-32B5AE	LL 5-lead Trunk Cable, AHA / IEC		
	U303-32C3A	ASP 3-lead Trunk Cable, AHA		
	U303-32C3E	ASP 3-lead Trunk Cable, IEC		
	U303-32C5A	ASP 5-lead Trunk Cable, AHA		
	U303-32C5E	ASP 5-lead Trunk Cable, IEC		
	U303-32D3A	Euro 3-lead Trunk Cable, AHA		
	U303-32D3E	Euro 3-lead Trunk Cable, IEC		
	U303-32D5A	Euro 5-lead Trunk Cable, AHA		
	U303-32D5E	Euro 5-lead Trunk Cable, IEC		
	Medtronic Physio-Control (6 pin)			
	(1KΩ resistor)	U373-12A3AE	Din 3-lead Trunk Cable, AHA / IEC	
U373-12A5AE		Din 5-lead Trunk Cable, AHA / IEC		
U373-12B3AE		LL 3-lead Trunk Cable, AHA / IEC		
U373-12B5AE		LL 5-lead Trunk Cable, AHA / IEC		
U373-12C3A		ASP 3-lead Trunk Cable, AHA		
U373-12C3E		ASP 3-lead Trunk Cable, IEC		
U373-12C5A		ASP 5-lead Trunk Cable, AHA		
U373-12C5E		ASP 5-lead Trunk Cable, IEC		
U373-12D3A		Euro 3-lead Trunk Cable, AHA		
U373-12D3E		Euro 3-lead Trunk Cable, IEC		
Medtronic Physio-Control (12 pin)				
U373-22A3AE	Din 3-lead Trunk Cable, AHA / IEC			

H~K

K~M

Brand/Compatible NO	P/N	Description	Image
Medtronic Physio-Control (12 pin)			
M~M	U373-22A5AE	Din 5-lead Trunk Cable,AHA / IEC	
	U373-22B3AE	LL 3-lead Trunk Cable,AHA / IEC	
	U373-22B5AE	LL 5-lead Trunk Cable,AHA / IEC	
	U373-22C3A	ASP 3-lead Trunk Cable,AHA	
	U373-22C3E	ASP 3-lead Trunk Cable,IEC	
	U373-22C5A	ASP 5-lead Trunk Cable,AHA	
	U373-22C5E	ASP 5-lead Trunk Cable,IEC	
	U373-22D3A	Euro 3-lead Trunk Cable,AHA	
	U373-22D3E	Euro 3-lead Trunk Cable,IEC	
	U373-22D5A	Euro 5-lead Trunk Cable,AHA	
	U373-22D5E	Euro 5-lead Trunk Cable,IEC	

Brand/Compatible NO	P/N	Description	Image
MEK (7 pin)			
M~M	U313-12A3AE	Din 3-lead Trunk Cable,AHA / IEC	
	U313-12A5AE	Din 5-lead Trunk Cable,AHA / IEC	
	U313-12B3AE	LL 3-lead Trunk Cable,AHA / IEC	
	U313-12B5AE	LL 5-lead Trunk Cable,AHA / IEC	
	U313-12C3A	ASP 3-lead Trunk Cable,AHA	
	U313-12C3E	ASP 3-lead Trunk Cable,IEC	
	U313-12C5A	ASP 5-lead Trunk Cable,AHA	
	U313-12C5E	ASP 5-lead Trunk Cable,IEC	
	U313-12D3A	Euro 3-lead Trunk Cable,AHA	
	U313-12D3E	Euro 3-lead Trunk Cable,IEC	
	U313-12D5A	Euro 5-lead Trunk Cable,AHA	
	U313-12D5E	Euro 5-lead Trunk Cable,IEC	

Brand/Compatible NO	P/N	Description	Image
MEK (9 pin)			
MP1000,MP600,MP500	U313-22A3AE	Din 3-lead Trunk Cable,AHA / IEC	
	U313-22A5AE	Din 5-lead Trunk Cable,AHA / IEC	
	U313-22B3AE	LL 3-lead Trunk Cable,AHA / IEC	
	U313-22B5AE	LL 5-lead Trunk Cable,AHA / IEC	

Brand/Compatible NO	P/N	Description	Image
MEK (9 pin)			
MP1000,MP600,MP500	U313-22C3A	ASP 3-lead Trunk Cable,AHA	
	U313-22C3E	ASP 3-lead Trunk Cable,IEC	
	U313-22C5A	ASP 5-lead Trunk Cable,AHA	
	U313-22C5E	ASP 5-lead Trunk Cable,IEC	
	U313-22D3A	Euro 3-lead Trunk Cable,AHA	
	U313-22D3E	Euro 3-lead Trunk Cable,IEC	
	U313-22D5A	Euro 5-lead Trunk Cable,AHA	
	U313-22D5E	Euro 5-lead Trunk Cable,IEC	

Brand/Compatible NO	P/N	Description	Image
MEK (6 pin)			
M~M	U313-32A3AE	Din 3-lead Trunk Cable,AHA / IEC	
	U313-32A5AE	Din 5-lead Trunk Cable,AHA / IEC	
	U313-32B3AE	LL 3-lead Trunk Cable,AHA / IEC	
	U313-32B5AE	LL 5-lead Trunk Cable,AHA / IEC	
	U313-32C3A	ASP 3-lead Trunk Cable,AHA	
	U313-32C3E	ASP 3-lead Trunk Cable,IEC	
	U313-32C5A	ASP 5-lead Trunk Cable,AHA	
	U313-32C5E	ASP 5-lead Trunk Cable,IEC	
	U313-32D3A	Euro 3-lead Trunk Cable,AHA	
	U313-32D3E	Euro 3-lead Trunk Cable,IEC	
	U313-32D5A	Euro 5-lead Trunk Cable,AHA	
	U313-32D5E	Euro 5-lead Trunk Cable,IEC	

Brand/Compatible NO	P/N	Description	Image
Mennen (12 pin)			
M~M	U320-12A3AE	Din 3-lead Trunk Cable,AHA / IEC	
	U320-12A5AE	Din 5-lead Trunk Cable,AHA / IEC	
	U320-12B3AE	LL 3-lead Trunk Cable,AHA / IEC	
	U320-12B5AE	LL 5-lead Trunk Cable,AHA / IEC	
	U320-12C3A	ASP 3-lead Trunk Cable,AHA	
	U320-12C3E	ASP 3-lead Trunk Cable,IEC	
	U320-12C5A	ASP 5-lead Trunk Cable,AHA	
	U320-12C5E	ASP 5-lead Trunk Cable,IEC	
	U320-12D3A	Euro 3-lead Trunk Cable,AHA	
	U320-12D3E	Euro 3-lead Trunk Cable,IEC	
	U320-12D5A	Euro 5-lead Trunk Cable,AHA	
	U320-12D5E	Euro 5-lead Trunk Cable,IEC	

Brand/Compatible NO	P/N	Description	Image
Nihon Kohden (8 pin)			
M~M	U305-12A3AE	Din 3-lead Trunk Cable,AHA / IEC	
	U305-12A5AE	Din 5-lead Trunk Cable,AHA / IEC	
	U305-12B3AE	LL 3-lead Trunk Cable,AHA / IEC	
	U305-12B5AE	LL 5-lead Trunk Cable,AHA / IEC	
	U305-12C3A	ASP 3-lead Trunk Cable,AHA	
	U305-12C3E	ASP 3-lead Trunk Cable,IEC	
	U305-12C5A	ASP 5-lead Trunk Cable,AHA	
	U305-12C5E	ASP 5-lead Trunk Cable,IEC	
	U305-12D3A	Euro 3-lead Trunk Cable,AHA	
	U305-12D3E	Euro 3-lead Trunk Cable,IEC	
	U305-12D5A	Euro 5-lead Trunk Cable,AHA	
	U305-12D5E	Euro 5-lead Trunk Cable,IEC	
	U305-12N3E	3/6-lead Trunk Cable,IEC	

Brand/Compatible NO	P/N	Description	Image
Nihon Kohden (11 pin)			
M~M	U305-22A3AE	Din 3-lead Trunk Cable,AHA / IEC	
	U305-22A5AE	Din 5-lead Trunk Cable,AHA / IEC	
	U305-22B3AE	LL 3-lead Trunk Cable,AHA / IEC	
	U305-22B5AE	LL 5-lead Trunk Cable,AHA / IEC	
	U305-22C3A	ASP 3-lead Trunk Cable,AHA	
	U305-22C3E	ASP 3-lead Trunk Cable,IEC	
	U305-22C5A	ASP 5-lead Trunk Cable,AHA	
	U305-22C5E	ASP 5-lead Trunk Cable,IEC	
	U305-22D3A	Euro 3-lead Trunk Cable,AHA	
	U305-22D3E	Euro 3-lead Trunk Cable,IEC	
	U305-22D5A	Euro 5-lead Trunk Cable,AHA	
	U305-22D5E	Euro 5-lead Trunk Cable,IEC	

Brand/Compatible NO	P/N	Description	Image
Nihon Kohden (13 pin)			
BSM-2300,BSM-4100,BSM-2301,BSM-2353,BSM-5100,BSM-9510,BSM9800,Multi-parameter Bedside Monitors	U305-22A3AE	Din 3-lead Trunk Cable,AHA / IEC	
	U305-22A5AE	Din 5-lead Trunk Cable,AHA / IEC	

Brand/Compatible NO	P/N	Description	Image
Nihon Kohden (13 pin)			
BSM-2300,BSM-4100,BSM-2301,BSM-2353,BSM-5100,BSM-9510,BSM9800,Multi-parameter Bedside Monitors	U305-22B3AE	LL 3-lead Trunk Cable,AHA / IEC	
	U305-22B5AE	LL 5-lead Trunk Cable,AHA / IEC	
	U305-22C3A	ASP 3-lead Trunk Cable,AHA	
	U305-22C3E	ASP 3-lead Trunk Cable,IEC	
	U305-22C5A	ASP 5-lead Trunk Cable,AHA	
	U305-22C5E	ASP 5-lead Trunk Cable,IEC	
	U305-22D3A	Euro 3-lead Trunk Cable,AHA	
	U305-22D3E	Euro 3-lead Trunk Cable,IEC	
	U305-22D5A	Euro 5-lead Trunk Cable,AHA	
	U305-22D5E	Euro 5-lead Trunk Cable,IEC	

Brand/Compatible NO	P/N	Description	Image
Nihon Kohden (20 pin)			
OPV-1500	U305-42F6A	6-lead Trunk Cable,AHA	
	U305-42F6E	6-lead Trunk Cable,IEC	

Brand/Compatible NO	P/N	Description	Image
Penlon (6 pin)			
M~M	U363-12A3AE	Din 3-lead Trunk Cable,AHA / IEC	
	U363-12A5AE	Din 5-lead Trunk Cable,AHA / IEC	
	U363-12B3AE	LL 3-lead Trunk Cable,AHA / IEC	
	U363-12B5AE	LL 5-lead Trunk Cable,AHA / IEC	
	U363-12C3A	ASP 3-lead Trunk Cable,AHA	
	U363-12C3E	ASP 3-lead Trunk Cable,IEC	
	U363-12C5A	ASP 5-lead Trunk Cable,AHA	
	U363-12C5E	ASP 5-lead Trunk Cable,IEC	
	U363-12D3A	Euro 3-lead Trunk Cable,AHA	
	U363-12D3E	Euro 3-lead Trunk Cable,IEC	
	U363-12D5A	Euro 5-lead Trunk Cable,AHA	
	U363-12D5E	Euro 5-lead Trunk Cable,IEC	

Brand/Compatible NO	P/N	Description	Image
Penlon (12 pin)			
M~M	U363-22A3AE	Din 3-lead Trunk Cable,AHA / IEC	
	U363-22A5AE	Din 5-lead Trunk Cable,AHA / IEC	
	U363-22B3AE	LL 3-lead Trunk Cable,AHA / IEC	

Brand/Compatible NO	P/N	Description	Image
Penlon (12 pin)			
	U363-22B5AE	LL 5-lead Trunk Cable,AHA / IEC	
	U363-22C3A	ASP 3-lead Trunk Cable,AHA	
	U363-22C3E	ASP 3-lead Trunk Cable,IEC	
	U363-22C5A	ASP 5-lead Trunk Cable,AHA	
	U363-22C5E	ASP 5-lead Trunk Cable,IEC	
	U363-22D3A	Euro 3-lead Trunk Cable,AHA	
	U363-22D3E	Euro 3-lead Trunk Cable,IEC	
	U363-22D5A	Euro 5-lead Trunk Cable,AHA	
	U363-22D5E	Euro 5-lead Trunk Cable,IEC	

Brand/Compatible NO	P/N	Description	Image
Penlon (12 pin)			
	U363-32A3AE	Din 3-lead Trunk Cable,AHA / IEC	
	U363-32A5AE	Din 5-lead Trunk Cable,AHA / IEC	
	U363-32B3AE	LL 3-lead Trunk Cable,AHA / IEC	
	U363-32B5AE	LL 5-lead Trunk Cable,AHA / IEC	
	U363-32C3A	ASP 3-lead Trunk Cable,AHA	
	U363-32C3E	ASP 3-lead Trunk Cable,IEC	
	U363-32C5A	ASP 5-lead Trunk Cable,AHA	
	U363-32C5E	ASP 5-lead Trunk Cable,IEC	
	U363-32D3A	Euro 3-lead Trunk Cable,AHA	
	U363-32D3E	Euro 3-lead Trunk Cable,IEC	
	U363-32D5A	Euro 5-lead Trunk Cable,AHA	
	U363-32D5E	Euro 5-lead Trunk Cable,IEC	

Brand/Compatible NO	P/N	Description	Image
Philips (8 pin)			
	U304-12A3AE	Din 3-lead Trunk Cable,AHA / IEC	
	U304-12A5AE	Din 5-lead Trunk Cable,AHA / IEC	
	U304-12B3AE	LL 3-lead Trunk Cable,AHA / IEC	
	U304-12B5AE	LL 5-lead Trunk Cable,AHA / IEC	
	U304-12C3A	ASP 3-lead Trunk Cable,AHA	
	U304-12C3E	ASP 3-lead Trunk Cable,IEC	
	U304-12C5A	ASP 5-lead Trunk Cable,AHA	
	U304-12C5E	ASP 5-lead Trunk Cable,IEC	

Brand/Compatible NO	P/N	Description	Image
Philips (8 pin)			
	U304-12D3A	Euro 3-lead Trunk Cable,AHA	
	U304-12D3E	Euro 3-lead Trunk Cable,IEC	
	U304-12D5A	Euro 5-lead Trunk Cable,AHA	
	U304-12D5E	Euro 5-lead Trunk Cable,IEC	
	U304-12H3A	AA 3-lead Trunk Cable,AHA	
	U304-12H3E	AA 3-lead Trunk Cable,IEC	
	U304-12H5A	AA 5-lead Trunk Cable,AHA	
	U304-12H5E	AA 5-lead Trunk Cable,IEC	
	U304-12P3A	New HP 3-lead Trunk Cable,AHA	
	U304-12P3E	New HP 3-lead Trunk Cable,IEC	
	U304-12P5AE	New HP 5-lead Trunk Cable,AHA / IEC	

Brand/Compatible NO	P/N	Description	Image
Philips (12 pin)			
	U304-22A3AE	Din 3-lead Trunk Cable,AHA / IEC	
	U304-22A5AE	Din 5-lead Trunk Cable,AHA / IEC	
	U304-22B3AE	LL 3-lead Trunk Cable,AHA / IEC	
	U304-22B5AE	LL 5-lead Trunk Cable,AHA / IEC	
	U304-22C3A	ASP 3-lead Trunk Cable,AHA	
	U304-22C3E	ASP 3-lead Trunk Cable,IEC	
	U304-22C5A	ASP 5-lead Trunk Cable,AHA	
	U304-22C5E	ASP 5-lead Trunk Cable,IEC	
	U304-22D3A	Euro 3-lead Trunk Cable,AHA	
	U304-22D3E	Euro 3-lead Trunk Cable,IEC	
	U304-22D5A	Euro 5-lead Trunk Cable,AHA	
	U304-22D5E	Euro 5-lead Trunk Cable,IEC	
	U304-22H3A	AA 3-lead Trunk Cable,AHA	
	U304-22H3E	AA 3-lead Trunk Cable,IEC	
	U304-22H5A	AA 5-lead Trunk Cable,AHA	
	U304-22H5E	AA 5-lead Trunk Cable,IEC	
	U304-22P3A	New HP 3-lead Trunk Cable,AHA	
	U304-22P3E	New HP 3-lead Trunk Cable,IEC	
	U304-22P5AE	New HP 5-lead Trunk Cable,AHA / IEC	

Brand/Compatible NO	P/N	Description	Image
Philips (12 pin)			
	U304-12A3AE	Din 3-lead Trunk Cable,AHA / IEC	
	U304-12A5AE	Din 5-lead Trunk Cable,AHA / IEC	
	U304-12B3AE	LL 3-lead Trunk Cable,AHA / IEC	
	U304-12B5AE	LL 5-lead Trunk Cable,AHA / IEC	
	U304-12C3A	ASP 3-lead Trunk Cable,AHA	
	U304-12C3E	ASP 3-lead Trunk Cable,IEC	
	U304-12C5A	ASP 5-lead Trunk Cable,AHA	
	U304-12C5E	ASP 5-lead Trunk Cable,IEC	

Brand/Compatible NO	P/N	Description	Image
S&W (Artema) (10 pin)			
	U332-12A3AE	Din 3-lead Trunk Cable,AHA / IEC	

Brand/Compatible NO	P/N	Description	Image
S&W (Artema) (10 pin)			
	U332-12A5AE	Din 5-lead Trunk Cable,AHA / IEC	
	U332-12B3AE	LL 3-lead Trunk Cable,AHA / IEC	
	U332-12B5AE	LL 5-lead Trunk Cable,AHA / IEC	
	U332-12C3A	ASP 3-lead Trunk Cable,AHA	
	U332-12C3E	ASP 3-lead Trunk Cable,IEC	
	U332-12C5A	ASP 5-lead Trunk Cable,AHA	
	U332-12C5E	ASP 5-lead Trunk Cable,IEC	
	U332-12D3A	Euro 3-lead Trunk Cable,AHA	
	U332-12D3E	Euro 3-lead Trunk Cable,IEC	
	U332-12D5A	Euro 5-lead Trunk Cable,AHA	
	U332-12D5E	Euro 5-lead Trunk Cable,IEC	

Brand/Compatible NO	P/N	Description	Image
Siemens (10 pin)			
	U315-12A3AE	Din 3-lead Trunk Cable,AHA / IEC	
	U315-12A5AE	Din 5-lead Trunk Cable,AHA / IEC	
	U315-12B3AE	LL 3-lead Trunk Cable,AHA / IEC	
	U315-12B5AE	LL 5-lead Trunk Cable,AHA / IEC	
	U315-12C3A	ASP 3-lead Trunk Cable,AHA	
	U315-12C3E	ASP 3-lead Trunk Cable,IEC	
	U315-12C5A	ASP 5-lead Trunk Cable,AHA	
	U315-12C5E	ASP 5-lead Trunk Cable,IEC	
	U315-12D3A	Euro 3-lead Trunk Cable,AHA	
	U315-12D3E	Euro 3-lead Trunk Cable,IEC	
	U315-12D5A	Euro 5-lead Trunk Cable,AHA	
	U315-12D5E	Euro 5-lead Trunk Cable,IEC	

Brand/Compatible NO	P/N	Description	Image
Siemens (16 pin)			
	U315-22E5AE	Multi-link ECG Trunk Cable,AHA / IEC	
	MS20093	Multi-link ECG Trunk Cable,AHA / IEC	
	U315-52E5AE	Multi-link ECG Trunk Cable,AHA / IEC	

Brand/Compatible NO	P/N	Description	Image
Siemens / Drager (7 pin)			
	U315-32A3AE	Din 3-lead Trunk Cable,AHA / IEC	
	U315-32B3AE	LL 3-lead Trunk Cable,AHA / IEC	
	U315-32C3A	ASP 3-lead Trunk Cable,AHA	
	U315-32C3E	ASP 3-lead Trunk Cable,IEC	
	U315-32D3A	Euro 3-lead Trunk Cable,AHA	
	U315-32D3E	Euro 3-lead Trunk Cable,IEC	

Brand/Compatible NO	P/N	Description	Image
Siemens / Drager (5 pin)			
	U315-42A4AE	Din 4-lead Trunk Cable,AHA / IEC	

Brand/Compatible NO	P/N	Description	Image
Schiller (12 pin)			
	U325-12A3AE	Din 3-lead Trunk Cable,AHA / IEC	
	U325-12A5AE	Din 5-lead Trunk Cable,AHA / IEC	
	U325-12B3AE	LL 3-lead Trunk Cable,AHA / IEC	
	U325-12B5AE	LL 5-lead Trunk Cable,AHA / IEC	
	U325-12C3A	ASP 3-lead Trunk Cable,AHA	
	U325-12C3E	ASP 3-lead Trunk Cable,IEC	
	U325-12C5A	ASP 5-lead Trunk Cable,AHA	
	U325-12C5E	ASP 5-lead Trunk Cable,IEC	
	U325-12D3A	Euro 3-lead Trunk Cable,AHA	
	U325-12D3E	Euro 3-lead Trunk Cable,IEC	
	U325-12D5A	Euro 5-lead Trunk Cable,AHA	
	U325-12D5E	Euro 5-lead Trunk Cable,IEC	

Brand/Compatible NO	P/N	Description	Image
Spacelabs (17 pin)			
	U307-12A3AE	Din 3-lead Trunk Cable,AHA / IEC	
	U307-12A5AE	Din 5-lead Trunk Cable,AHA / IEC	
	U307-12B3AE	LL 3-lead Trunk Cable,AHA / IEC	
	U307-12B5AE	LL 5-lead Trunk Cable,AHA / IEC	
	U307-12K3AE	SL 3-lead Trunk Cable,AHA / IEC	
	U307-12K5AE	SL 5-lead Trunk Cable,AHA / IEC	

Brand/Compatible NO	P/N	Description	Image		
Spacelabs (17 pin)					
90492, 91220, 91496, 90496, 90369, 90367 Ultraview	U307-12C3A	ASP 3-lead Trunk Cable,AHA			
	U307-12C3E	ASP 3-lead Trunk Cable,IEC			
	U307-12C5A	ASP 5-lead Trunk Cable,AHA			
	U307-12C5E	ASP 5-lead Trunk Cable,IEC			
	U307-12D3A	Euro 3-lead Trunk Cable,AHA			
	U307-12D3E	Euro 3-lead Trunk Cable,IEC			
	U307-12D5A	Euro 5-lead Trunk Cable,AHA			
	U307-12D5E	Euro 5-lead Trunk Cable,IEC			
	Unicare (12 pin)				
90492, 91220, 91496, 90496, 90369, 90367 Ultraview	U358-12A3AE	Din 3-lead Trunk Cable,AHA / IEC			
	U358-12A5AE	Din 5-lead Trunk Cable,AHA / IEC			
	U358-12B3AE	LL 3-lead Trunk Cable,AHA / IEC			
	U358-12B5AE	LL 5-lead Trunk Cable,AHA / IEC			
	U358-12C3A	ASP 3-lead Trunk Cable,AHA			
	U358-12C3E	ASP 3-lead Trunk Cable,IEC			
	U358-12C5A	ASP 5-lead Trunk Cable,AHA			
	U358-12C5E	ASP 5-lead Trunk Cable,IEC			
	U358-12D3A	Euro 3-lead Trunk Cable,AHA			
	U358-12D3E	Euro 3-lead Trunk Cable,IEC			
	U358-12D5A	Euro 5-lead Trunk Cable,AHA			
	U358-12D5E	Euro 5-lead Trunk Cable,IEC			
	Weich Allyn (6 pin)				
	Propaq 100 series, Propaq 200 series, propaq Encore, Propaq CS, Ultra Smart, Atlas (1KΩ resistor)	U361-12A3AE		Din 3-lead Trunk Cable,AHA / IEC	
		U361-12A5AE		Din 5-lead Trunk Cable,AHA / IEC	
		U361-12B3AE		LL 3-lead Trunk Cable,AHA / IEC	
		U361-12B5AE		LL 5-lead Trunk Cable,AHA / IEC	
		U361-12C3A		ASP 3-lead Trunk Cable,AHA	
U361-12C3E		ASP 3-lead Trunk Cable,IEC			
U361-12C5A		ASP 5-lead Trunk Cable,AHA			
U361-12C5E		ASP 5-lead Trunk Cable,IEC			
U361-12D3A		Euro 3-lead Trunk Cable,AHA			
U361-12D3E		Euro 3-lead Trunk Cable,IEC			
U361-12D5A		Euro 5-lead Trunk Cable,AHA			
U361-12D5E		Euro 5-lead Trunk Cable,IEC			

Brand/Compatible NO	P/N	Description	Image		
Weich Allyn (9 pin)					
(1KΩ resistor)	U361-22A3AE	Din 3-lead Trunk Cable,AHA / IEC			
	U361-22A5AE	Din 5-lead Trunk Cable,AHA / IEC			
	U361-22B3AE	LL 3-lead Trunk Cable,AHA / IEC			
	U361-22B5AE	LL 5-lead Trunk Cable,AHA / IEC			
	U361-22C3A	ASP 3-lead Trunk Cable,AHA			
	U361-22C3E	ASP 3-lead Trunk Cable,IEC			
	U361-22C5A	ASP 5-lead Trunk Cable,AHA			
	U361-22C5E	ASP 5-lead Trunk Cable,IEC			
	U361-22D3A	Euro 3-lead Trunk Cable,AHA			
	U361-22D3E	Euro 3-lead Trunk Cable,IEC			
	U361-22D5A	Euro 5-lead Trunk Cable,AHA			
	U361-22D5E	Euro 5-lead Trunk Cable,IEC			
	Zoll (6 pin)				
	(1KΩ resistor)	U347-12A3AE		Din 3-lead Trunk Cable,AHA / IEC	
		U347-12A5AE		Din 5-lead Trunk Cable,AHA / IEC	
		U347-12B3AE		LL 3-lead Trunk Cable,AHA / IEC	
		U347-12B5AE		LL 5-lead Trunk Cable,AHA / IEC	
		U347-12C3A		ASP 3-lead Trunk Cable,AHA	
U347-12C3E		ASP 3-lead Trunk Cable,IEC			
U347-12C5A		ASP 5-lead Trunk Cable,AHA			
U347-12C5E		ASP 5-lead Trunk Cable,IEC			
U347-12D3A		Euro 3-lead Trunk Cable,AHA			
U347-12D3E		Euro 3-lead Trunk Cable,IEC			
U347-12D5A		Euro 5-lead Trunk Cable,AHA			
U347-12D5E		Euro 5-lead Trunk Cable,IEC			
Zoncare (6 pin)					
90492, 91220, 91496, 90496, 90369, 90367 Ultraview		U399-12A3AE	Din 3-lead Trunk Cable,AHA / IEC		
		U399-12A5AE	Din 5-lead Trunk Cable,AHA / IEC		
		U399-12B3AE	LL 3-lead Trunk Cable,AHA / IEC		
		U399-12B5AE	LL 5-lead Trunk Cable,AHA / IEC		
		U399-12C3A	ASP 3-lead Trunk Cable,AHA		
	U399-12C3E	ASP 3-lead Trunk Cable,IEC			
	U399-12C5A	ASP 5-lead Trunk Cable,AHA			
	U399-12C5E	ASP 5-lead Trunk Cable,IEC			
	U399-12D3A	Euro 3-lead Trunk Cable,AHA			
	U399-12D3E	Euro 3-lead Trunk Cable,IEC			
	U399-12D5A	Euro 5-lead Trunk Cable,AHA			
	U399-12D5E	Euro 5-lead Trunk Cable,IEC			

Brand/Compatible NO	P/N	Description	Image		
Zoncare (6 pin)					
90492, 91220, 91496, 90496, 90369, 90367 Ultraview	U399-12C3A	ASP 3-lead Trunk Cable,AHA			
	U399-12C3E	ASP 3-lead Trunk Cable,IEC			
	U399-12C5A	ASP 5-lead Trunk Cable,AHA			
	U399-12C5E	ASP 5-lead Trunk Cable,IEC			
	U399-12D3A	Euro 3-lead Trunk Cable,AHA			
	U399-12D3E	Euro 3-lead Trunk Cable,IEC			
	U399-12D5A	Euro 5-lead Trunk Cable,AHA			
	U399-12D5E	Euro 5-lead Trunk Cable,IEC			
	ECG leadwires				
	Din				
90492, 91220, 91496, 90496, 90369, 90367 Ultraview	U301-3A3SA	Din 3-lead leadwires_Snap,AHA			
	U301-3A3SE	Din 3-lead leadwires_Snap,IEC			
	U301-3A3CA	Din 3-lead leadwires_Clip,AHA			
	U301-3A3CE	Din 3-lead leadwires_Clip,IEC			
	U301-3A5SA	Din 5-lead leadwires_Snap,AHA			
	U301-3A5SE	Din 5-lead leadwires_Snap,IEC			
	U301-3A5CA	Din 5-lead leadwires_Clip,AHA			
	U301-3A5CE	Din 5-lead leadwires_Clip,IEC			
	U301-3A3MA	Din 3-lead leadwires_Mini Clip,AHA			
	U301-3A3ME	Din 3-lead leadwires_Mini Clip,IEC			
	U301-3A5MA	Din 5-lead leadwires_Mini Clip,AHA			
	U301-3A5ME	Din 5-lead leadwires_Mini Clip,IEC			
	LL				
	90492, 91220, 91496, 90496, 90369, 90367 Ultraview	U301-3B3SA		LL 3-lead leadwires_Snap,AHA	
		U301-3B3SE		LL 3-lead leadwires_Snap,IEC	
		U301-3B3CA		LL 3-lead leadwires_Clip,AHA	
		U301-3B3CE		LL 3-lead leadwires_Clip,IEC	
		U301-3B5SA		LL 5-lead leadwires_Snap,AHA	
U301-3B5SE		LL 5-lead leadwires_Snap,IEC			
U301-3B5CA		LL 5-lead leadwires_Clip,AHA			
U301-3B5CE		LL 5-lead leadwires_Clip,IEC			
Colin					
90492, 91220, 91496, 90496, 90369, 90367 Ultraview		U341-3J3SA	Colin 3-lead leadwires_Snap,AHA		
		U341-3J3SE	Colin 3-lead leadwires_Snap,IEC		
		U341-3J3CA	Colin 3-lead leadwires_Clip,AHA		
		U341-3J3CE	Colin 3-lead leadwires_Clip,IEC		
		U306-3C3SA	ASP 3-lead leadwires_Snap,AHA		
		U306-3C3SE	ASP 3-lead leadwires_Snap,IEC		
Datex(ASP Type)					
90492, 91220, 91496, 90496, 90369, 90367 Ultraview		U306-3C3CA	ASP 3-lead leadwires_Clip,AHA		
		U306-3C3CE	ASP 3-lead leadwires_Clip,IEC		
	U306-3C5SA	ASP 5-lead leadwires_Snap,AHA			
	U306-3C5SE	ASP 5-lead leadwires_Snap,IEC			
	U306-3C5CA	ASP 5-lead leadwires_Clip,AHA			
	U306-3C5CE	ASP 5-lead leadwires_Clip,IEC			
	Datascope				
	90492, 91220, 91496, 90496, 90369, 90367 Ultraview	U314-3R3SA	3-lead leadwires_Snap,AHA		
		U314-3R3SE	3-lead leadwires_Snap,IEC		
		U314-3R3CA	3-lead leadwires_Clip,AHA		
		U314-3R3CE	3-lead leadwires_Clip,IEC		
		U314-3R5SA	5-lead leadwires_Snap,AHA		
U314-3R5SE		5-lead leadwires_Snap,IEC			
U314-3R5CA		5-lead leadwires_Clip,AHA			
U314-3R5CE		5-lead leadwires_Clip,IEC			
GE(VS type)					
90492, 91220, 91496, 90496, 90369, 90367 Ultraview		U302-3G3SA	VS 3-lead leadwires_Snap,AHA		
		U302-3G3SE	VS 3-lead leadwires_Snap,IEC		
		U302-3G3CA	VS 3-lead leadwires_Clip,AHA		
	U302-3G3CE	VS 3-lead leadwires_Clip,IEC			
	U302-3G5SA	VS 5-lead leadwires_Snap,AHA			
	U302-3G5SE	VS 5-lead leadwires_Snap,IEC			
	U302-3G5CA	VS 5-lead leadwires_Clip,AHA			
	U302-3G5CE	VS 5-lead leadwires_Clip,IEC			

Brand/Compatible NO	P/N	Description	Image
90492, 91220, 91496, 90496, 90369, 90367 Ultraview	U303-3D3SA	Euro 3-lead leadwires_Snap,AHA	
	U303-3D3SE	Euro 3-lead leadwires_Snap,IEC	
	U303-3D3CA	Euro 3-lead leadwires_Clip,AHA	
	U303-3D3CE	Euro 3-lead leadwires_Clip,IEC	
	U303-3D5SA	Euro 5-lead leadwires_Snap,AHA	
	U303-3D5SE	Euro 5-lead leadwires_Snap,IEC	
	U303-3D5CA	Euro 5-lead leadwires_Clip,AHA	
	U303-3D5CE	Euro 5-lead leadwires_Clip,IEC	
	U303-3D3MA	Euro 3-lead leadwires_Mini Clip,AHA	
	U303-3D3ME	Euro 3-lead leadwires_Mini Clip,IEC	
	U303-3D5MA	Euro 5-lead leadwires_Mini Clip,AHA	
	U303-3D5ME	Euro 5-lead leadwires_Mini Clip,IEC	
Nihon Kohden BR-019 BR-019P BR-021P	U305-3N3SA	NK 3-lead leadwires_Snap,AHA	
	U305-3N3SE	NK 3-lead leadwires_Snap,IEC	
	U305-3N3CA	NK 3-lead leadwires_Clip,AHA	
Nihon Kohden BR-913P BR-903P BR-906P	U305-3N3CE	NK 3-lead leadwires_Clip,IEC	
	U305-3F3SA	NK 3-lead leadwires_Snap,AHA	
	U305-3F3SE	NK 3-lead leadwires_Snap,IEC	
	U305-3F3CA	NK 3-lead leadwires_Clip,AHA	
	U305-3F3CE	NK 3-lead leadwires_Clip,IEC	
	U305-3F6SA	NK 6-lead leadwires_Snap,AHA	
Philips/HP M1605A M1603A M1615A M1613A M1625A M1623A M1635A M1633A	U305-3F6SE	NK 6-lead leadwires_Snap,IEC	
	U305-3F6CA	NK 6-lead leadwires_Clip,AHA	
	U305-3F6CE	NK 6-lead leadwires_Clip,IEC	
	U304-3H3SA	AA 3-lead leadwires_Snap,AHA	
	U304-3H3SE	AA 3-lead leadwires_Snap,IEC	
	U304-3H3CA	AA 3-lead leadwires_Clip,AHA	
	U304-3H3CE	AA 3-lead leadwires_Clip,IEC	
	U304-3H5SA	AA 5-lead leadwires_Snap,AHA	
	U304-3H5SE	AA 5-lead leadwires_Snap,IEC	
	U304-3H5CA	AA 5-lead leadwires_Clip,AHA	
	U304-3H5CE	AA 5-lead leadwires_Clip,IEC	
	Philips M1673A M1674A M1671A M1672A M1644A M1645A M1968A M1971A	U304-3H3MA	
U304-3H3ME		AA 3-lead leadwires_Mini Clip,IEC	
U304-3H5MA		AA 5-lead leadwires_Mini Clip,AHA	
U304-3H5ME		AA 5-lead leadwires_Mini Clip,IEC	
U304-3P3SA		New HP 3-lead leadwires_Snap,AHA	
U304-3P3SE		New HP 3-lead leadwires_Snap,IEC	
U304-3P3CA		New HP 3-lead leadwires_Clip,AHA	
U304-3P3CE		New HP 3-lead leadwires_Clip,IEC	
U304-3P5SA		New HP 5-lead leadwires_Snap,AHA	
U304-3P5SE		New HP 5-lead leadwires_Snap,IEC	
U304-3P5CA		New HP 5-lead leadwires_Clip,AHA	
U304-3P5CE		New HP 5-lead leadwires_Clip,IEC	
Spacelabs	U307-3K3SA	3-lead leadwires_Snap,AHA	
	U307-3K3SE	3-lead leadwires_Snap,IEC	
	U307-3K3CA	3-lead leadwires_Clip,AHA	
	U307-3K3CE	3-lead leadwires_Clip,IEC	
	U307-3K5SA	5-lead leadwires_Snap,AHA	
	U307-3K5SE	5-lead leadwires_Snap,IEC	
	U307-3K5CA	5-lead leadwires_Clip,AHA	
	U307-3K5CE	5-lead leadwires_Clip,IEC	
Siemens	U315-3D3SA	Euro 3-lead leadwires_Snap,AHA	
	U315-3D3SE	Euro 3-lead leadwires_Snap,IEC	
	U315-3D3CA	Euro 3-lead leadwires_Clip,AHA	
	U315-3D3CE	Euro 3-lead leadwires_Clip,IEC	
	U315-3D5SA	Euro 5-lead leadwires_Snap,AHA	
	U315-3D5SE	Euro 5-lead leadwires_Snap,IEC	
	U315-3D5CA	Euro 5-lead leadwires_Clip,AHA	
	U315-3D5CE	Euro 5-lead leadwires_Clip,IEC	

ECG leadwires			
Brand/Compatible NO	P/N	Description	Image
Siemens	U315-3S3SA	3-lead leadwires_Snap_AHA	
	U315-3S3SE	3-lead leadwires_Snap_IEC	
	U315-3S3CA	3-lead leadwires_Clip_AHA	
	U315-3S3CE	3-lead leadwires_Clip_IEC	
	U315-3S5SA	5-lead leadwires_Snap_AHA	
	U315-3S5SE	5-lead leadwires_Snap_IEC	
	U315-3S5CA	5-lead leadwires_Clip_AHA	
	U315-3S5CE	5-lead leadwires_Clip_IEC	
	U315-3S6SA	6-lead leadwires_Snap_AHA	
	U315-3S6SE	6-lead leadwires_Snap_IEC	
U315-3S6CA	6-lead leadwires_Clip_AHA		
U315-3S6CE	6-lead leadwires_Clip_IEC		

Disposable ECG Electrodes			
Brand/Compatible NO	P/N	Description	Image
	U902-1A	Disposable Adult ECG electrode, 50pcs/bag	
	U902-1B	Disposable Child ECG electrode, 50pcs/bag	
	U902-1C	Disposable Neonate ECG electrode, 50pcs/bag	

Disposable ECG Leadwires				
Brand/Compatible NO	P/N	Description	Image	
DIN Type	U301-DA3AA	Din 3-lead Leadwires with adult electrodes_AHA,0.9M		
	U301-DA3PA	Din 3-lead Leadwires with pediatric electrodes_AHA,0.9M		
	U301-DA3NA	Din 3-lead Leadwires with Neonatal electrodes_AHA,0.9M		
	U301-DA3NE	Din 3-lead Leadwires with Neonatal electrodes_IEC,0.9M		
	U301-DA5AA	Din 5-lead Leadwires with adult electrodes_AHA,0.9M		
	U301-DA5PA	Din 5-lead Leadwires with pediatric electrodes_AHA,0.9M		
	U301-DA5NA	Din 5-lead Leadwires with Neonatal electrodes_AHA,0.9M		
	U301-DA5NE	Din 5-lead Leadwires with Neonatal electrodes_IEC,0.9M		
	DIN Type	U301-DA3SA		Din 3-lead leadwires_Snap_AHA,0.9M
		U301-DA3SE		Din 3-lead leadwires_Snap_IEC,0.9M
U301-DA3CA		Din 3-lead leadwires_Clip_AHA,0.9M		
U301-DA3CE		Din 3-lead leadwires_Clip_IEC,0.9M		
U301-DA5SA		Din 5-lead leadwires_Snap_AHA,0.9M		
Philips	U304-DP3SA	New HP 3-lead leadwires_Snap_AHA,0.9M		
	U304-DP3SE	New HP 3-lead leadwires_Snap_IEC, 0.9M		
	U304-DP3CA	New HP 3-lead leadwires_Clip_AHA, 0.9M		
	U304-DP3CE	New HP 3-lead leadwires_Clip_IEC, 0.9M		
	U304-DP5SA	New HP 5-lead leadwires_Snap_AHA,0.9M		
	U304-DP5SE	New HP 5-lead leadwires_Snap_IEC, 0.9M		
	U304-DP5CA	New HP 5-lead leadwires_Clip_AHA, 0.9M		
	U304-DP5CE	New HP 5-lead leadwires_Clip_IEC, 0.9M		



EKG Cable with leadwires

HOT PRODUCT DISPLAY



U202-11BA — A:AHA E:IEC G:Original AHA or AHA/IEC H:Original IEC
 B:Banana 4.0mm D:Din 3.0mm S:Snap C:Clip
 1:Compatible model No
 1:One-piece 2:EKG trunk cable 3:EKG Leadwire 4:Data cable
 02:Compatible brand No (eq GE:02, Mindray:03)
 2:Indicate EKG cable
 UpnMed

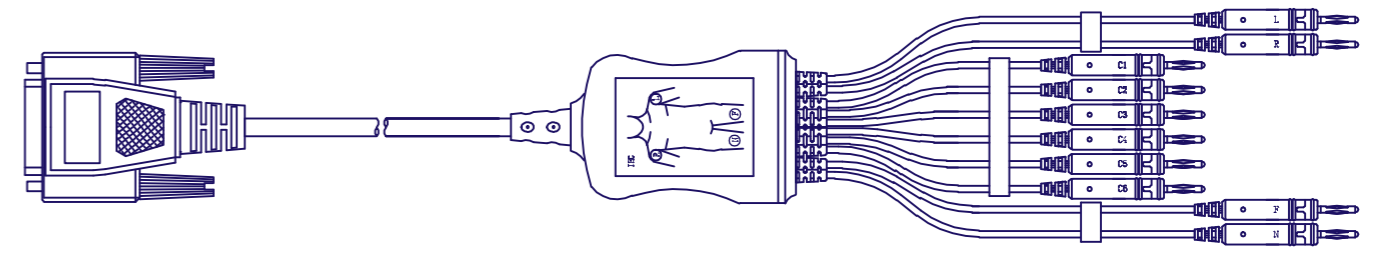

EKG CONNECTOR



LEAD POSITION MARKED

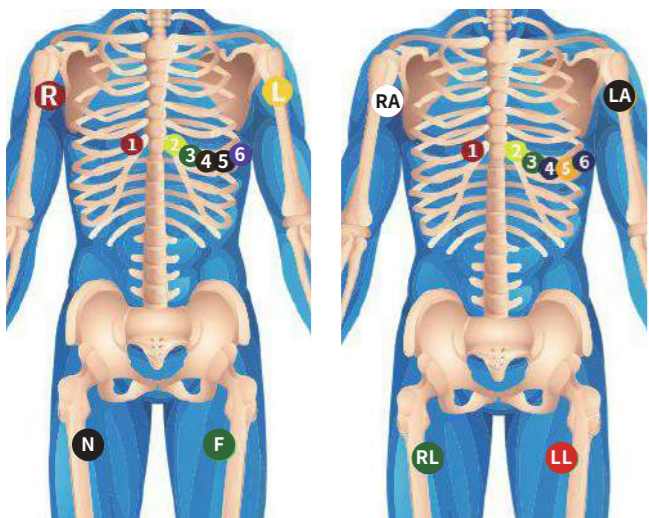

PATIENT SIDE



Hot product display



Compatible Model	P/N	Description	Image
Bionet			
(10KΩ resistor)	U223-11BA	10-lead cable and leads, Banana 4.0mm,AHA	
	U223-11BE	10-lead cable and leads, Banana 4.0mm,IEC	
	U223-11DA	10-lead cable and leads, Din 3.0mm,AHA	
	U223-11DE	10-lead cable and leads, Din 3.0mm,IEC	
	U223-11SA	10-lead cable and leads, Snap,AHA	
	U223-11SE	10-lead cable and leads, Snap,IEC	
	U223-11CA	10-lead cable and leads, Clip,AHA	
	U223-11CE	10-lead cable and leads, Clip,IEC	
Biocare			
ECG-101/101G/300/300G,ECG-1200,ECG-9803	U246-11BA	10-lead cable and leads, Banana 4.0mm,AHA	
	U246-11BE	10-lead cable and leads, Banana 4.0mm,IEC	
	U246-11DA	10-lead cable and leads, Din 3.0mm,AHA	
	U246-11DE	10-lead cable and leads, Din 3.0mm,IEC	
	U246-11SA	10-lead cable and leads, Snap,AHA	
	U246-11SE	10-lead cable and leads, Snap,IEC	
BTL			
BTL-08 (4.7KΩ resistor)	U2107-11BA	10-lead cable and leads, Banana 4.0mm,AHA	
	U2107-11BE	10-lead cable and leads, Banana 4.0mm,IEC	
	U2107-11DA	10-lead cable and leads, Din 3.0mm,AHA	
	U2107-11DE	10-lead cable and leads, Din 3.0mm,IEC	
	U2107-11SA	10-lead cable and leads, Snap,AHA	
	U2107-11SE	10-lead cable and leads, Snap,IEC	
Burdick Quinton			
Burdick (quinton):Eclipse 4,Eclipse400, Eclipse8, Elipse800,Eclipse 850, Eclipse 850i,Eclipse Plus,Eclipse LE II Burdick with serial Number starting with 1067 or 92304, Atria: Atria Plus, Atria3000.	U245-11BA	10-lead cable and leads, Banana 4.0mm,AHA	
	U245-11BE	10-lead cable and leads, Banana 4.0mm,IEC	
	U245-11DA	10-lead cable and leads, Din 3.0mm,AHA	
	U245-11DE	10-lead cable and leads, Din 3.0mm,IEC	
	U245-11SA	10-lead cable and leads, Snap,AHA	
	U245-11SE	10-lead cable and leads, Snap,IEC	
Burdick			
EK-10	U245-21BA	10-lead cable and leads, Banana 4.0mm,AHA	
	U245-21BE	10-lead cable and leads, Banana 4.0mm,IEC	
	U245-21DA	10-lead cable and leads, Din 3.0mm,AHA	
	U245-21DE	10-lead cable and leads, Din 3.0mm,IEC	
	U245-21SA	10-lead cable and leads, Snap,AHA	
	U245-21SE	10-lead cable and leads, Snap,IEC	
Burdick			
Elite,Elitell,E-350, E350i,E550,E560,Burdick #007705,Stress cable with detachable leads 007706 (4.7KΩ resistor)	U245-31BA	10-lead cable and leads, Banana 4.0mm,AHA	
	U245-31BE	10-lead cable and leads, Banana 4.0mm,IEC	
	U245-31DA	10-lead cable and leads, Din 3.0mm,AHA	
	U245-31DE	10-lead cable and leads, Din 3.0mm,IEC	
	U245-31SA	10-lead cable and leads, Snap,AHA	
	U245-31SE	10-lead cable and leads, Snap,IEC	
Comen			
U238-11BA	U238-11BA	10-lead cable and leads, Banana 4.0mm,AHA	
	U238-11BE	10-lead cable and leads, Banana 4.0mm,IEC	
	U238-11DA	10-lead cable and leads, Din 3.0mm,AHA	
	U238-11DE	10-lead cable and leads, Din 3.0mm,IEC	
	U238-11SA	10-lead cable and leads, Snap,AHA	
	U238-11SE	10-lead cable and leads, Snap,IEC	
Carewell			
U290-11BA	U290-11BA	10-lead cable and leads, Banana 4.0mm,AHA	
	U290-11BE	10-lead cable and leads, Banana 4.0mm,IEC	
	U290-11DA	10-lead cable and leads, Din 3.0mm,AHA	
	U290-11DE	10-lead cable and leads, Din 3.0mm,IEC	
	U290-11SA	10-lead cable and leads, Snap,AHA	
	U290-11SE	10-lead cable and leads, Snap,IEC	
Dixtal			
U295-11BA	U295-11BA	10-lead cable and leads, Banana 4.0mm,AHA	
	U295-11BE	10-lead cable and leads, Banana 4.0mm,IEC	
	U295-11DA	10-lead cable and leads, Din 3.0mm,AHA	
	U295-11DE	10-lead cable and leads, Din 3.0mm,IEC	
	U295-11SA	10-lead cable and leads, Snap,AHA	
	U295-11SE	10-lead cable and leads, Snap,IEC	

Compatible Model	P/N	Description	Image
Dongjiang			
ECG-11A,ECG-11B, ECG-11D,ECG-32A, ECG-32A(II),ECG-120	U235-11BA	10-lead cable and leads, Banana 4.0mm,AHA	
	U235-11BE	10-lead cable and leads, Banana 4.0mm,IEC	
	U235-11DA	10-lead cable and leads, Din 3.0mm,AHA	
	U235-11DE	10-lead cable and leads, Din 3.0mm,IEC	
	U235-11SA	10-lead cable and leads, Snap,AHA	
	U235-11SE	10-lead cable and leads, Snap,IEC	
Edan			
SE-3,SE-12 Express, SE-601A,SE-601B,SE-601C, SE-1010PC, SE-1200, SE-12 Express,ST-1212	U272-11BA	10-lead cable and leads, Banana 4.0mm,AHA	
	U272-11BE	10-lead cable and leads, Banana 4.0mm,IEC	
	U272-11DA	10-lead cable and leads, Din 3.0mm,AHA	
	U272-11DE	10-lead cable and leads, Din 3.0mm,IEC	
	U272-11SA	10-lead cable and leads, Snap,AHA	
	U272-11SE	10-lead cable and leads, Snap,IEC	
Edan			
U272-21BA	U272-21BA	10-lead cable and leads, Banana 4.0mm,AHA	
	U272-21BE	10-lead cable and leads, Banana 4.0mm,IEC	
	U272-21DA	10-lead cable and leads, Din 3.0mm,AHA	
	U272-21DE	10-lead cable and leads, Din 3.0mm,IEC	
	U272-21SA	10-lead cable and leads, Snap,AHA	
	U272-21SE	10-lead cable and leads, Snap,IEC	
Edan			
U272-31BA	U272-31BA	10-lead cable and leads, Banana 4.0mm,AHA	
	U272-31BE	10-lead cable and leads, Banana 4.0mm,IEC	
	U272-31DA	10-lead cable and leads, Din 3.0mm,AHA	
	U272-31DE	10-lead cable and leads, Din 3.0mm,IEC	
	U272-31SA	10-lead cable and leads, Snap,AHA	
	U272-31SE	10-lead cable and leads, Snap,IEC	
Fukuda Denshi			
Alpha500/600, FCP2201 (4.7KΩ resistor)	U269-11BA	10-lead cable and leads, Banana 4.0mm,AHA	
	U269-11BE	10-lead cable and leads, Banana 4.0mm,IEC	
	U269-11DA	10-lead cable and leads, Din 3.0mm,AHA	
	U269-11DE	10-lead cable and leads, Din 3.0mm,IEC	
	U269-11SA	10-lead cable and leads, Snap,AHA	
	U269-11SE	10-lead cable and leads, Snap,IEC	
Fukuda Denshi			
Autocardiner, Cardimax FX-2111/FX-3010/FX-4010,FCP-2155 (4.7KΩ resistor)	U269-21BA	10-lead cable and leads, Banana 4.0mm,AHA	
	U269-21BE	10-lead cable and leads, Banana 4.0mm,IEC	
	U269-21DA	10-lead cable and leads, Din 3.0mm,AHA	
	U269-21DE	10-lead cable and leads, Din 3.0mm,IEC	
	U269-21SA	10-lead cable and leads, Snap,AHA	
	U269-21SE	10-lead cable and leads, Snap,IEC	
Fukuda ME			
Cardisunny Alpha 1000,Cardisunny Alpha 6600A/AX (4.7KΩ resistor)	U269-31BA	10-lead cable and leads, Banana 4.0mm,AHA	
	U269-31BE	10-lead cable and leads, Banana 4.0mm,IEC	
	U269-31DE	10-lead cable and leads, Din 3.0mm,IEC	
	U269-31SA	10-lead cable and leads, Snap,AHA	
	U269-31SE	10-lead cable and leads, Snap,IEC	
	U269-31CE	10-lead cable and leads, Clip,AHA	
Fukuda ME			
KP-500 (without resistor)	U269-41BA	10-lead cable and leads, Banana 4.0mm,AHA	
	U269-41BE	10-lead cable and leads, Banana 4.0mm,IEC	
	U269-41DA	10-lead cable and leads, Din 3.0mm,AHA	
	U269-41DE	10-lead cable and leads, Din 3.0mm,IEC	
	U269-41SA	10-lead cable and leads, Snap,AHA	
	U269-41SE	10-lead cable and leads, Snap,IEC	
Fukuda ME			
KP-500D (20KΩ resistor)	U269-51BA	10-lead cable and leads, Banana 4.0mm,AHA	
	U269-51BE	10-lead cable and leads, Banana 4.0mm,IEC	
	U269-51DE	10-lead cable and leads, Din 3.0mm,IEC	
	U269-51SA	10-lead cable and leads, Snap,AHA	
	U269-51CA	10-lead cable and leads, Clip,AHA	
	U269-51CE	10-lead cable and leads, Clip,IEC	

B~F





Compatible Model	P/N	Description	Image		
Fukuda ME					
C110, C220 (10KΩ resistor)	U269-61BA	10-lead cable and leads, Banana 4.0mm,AHA			
	U269-61BE	10-lead cable and leads, Banana 4.0mm,IEC			
	U269-61DA	10-lead cable and leads, Din 3.0mm,AHA			
	U269-61DE	10-lead cable and leads, Din 3.0mm,IEC			
	U269-61SA	10-lead cable and leads, Snap,AHA			
	U269-61SE	10-lead cable and leads, Snap,IEC			
GE	U269-61CA	10-lead cable and leads, Clip,AHA			
	U269-61CE	10-lead cable and leads, Clip,IEC			
	U202-11BA	10-lead cable and leads, Banana 4.0mm,AHA			
	U202-11BE	10-lead cable and leads, Banana 4.0mm,IEC			
	U202-11DA	10-lead cable and leads, Din 3.0mm,AHA			
	U202-11DE	10-lead cable and leads, Din 3.0mm,IEC			
U202-11SA	10-lead cable and leads, Snap,AHA				
U202-11SE	10-lead cable and leads, Snap,IEC				
Hellige-Microsmart, MAC5001/100/MAC1200/1200ST (10KΩ resistor)	U202-11CA	10-lead cable and leads, Clip,AHA			
	U202-11CE	10-lead cable and leads, Clip,IEC			
	U202-21BA	10-lead cable and leads, Banana 4.0mm,AHA			
	U202-21BE	10-lead cable and leads, Banana 4.0mm,IEC			
	U202-21DA	10-lead cable and leads, Din 3.0mm,AHA			
	U202-21DE	10-lead cable and leads, Din 3.0mm,IEC			
U202-21SA	10-lead cable and leads, Snap,AHA				
U202-21SE	10-lead cable and leads, Snap,IEC				
GE (1KΩ resistor)	U202-21CA	10-lead cable and leads, Clip,AHA			
	U202-21CE	10-lead cable and leads, Clip,IEC			
	HDMI				
	U242-11BA	U242-11BE		10-lead cable and leads, Banana 4.0mm,AHA	
		U242-11DE		10-lead cable and leads, Din 3.0mm,IEC	
		U242-11SA		10-lead cable and leads, Snap,AHA	
U242-11SE		10-lead cable and leads, Snap,IEC			
U242-11CA		10-lead cable and leads, Clip,AHA			
U242-11CE		10-lead cable and leads, Clip,IEC			
Hellige/Siemens					
Siemens:Cardiostat 1/3T/703/710,Cardina C,Cardirex 3T/4/6T/62, Cathcor,Megacard Elema A/B, R, RE, Mingodoc,Mingocard3/4/7, Mingograph 4/62/81, Mingograph 82/740, Mingolog 7, Miracard 1, Sirecard440/440S/460/460S/740,Sierex,Sirecard 803,Sirecust 701 Hellige:EK36/41/43/53/56/403/413/512/512 E/512P,Cardiosmart, CardioSys, Cora Custo-med,Custo-card, Bosch:603 D, 603 ER, 603S,606DEGO: Cardiomed 3 Cambridge:CM6000, CM6400.	U227-11BA	10-lead cable and leads, Banana 4.0mm,AHA			
	U227-11BE	10-lead cable and leads, Banana 4.0mm,IEC			
	U227-11DA	10-lead cable and leads, Din 3.0mm,AHA			
	U227-11DE	10-lead cable and leads, Din 3.0mm,IEC			
	U227-11SA	10-lead cable and leads, Snap,AHA			
	U227-11SE	10-lead cable and leads, Snap,IEC			
	U227-11CA	10-lead cable and leads, Clip,AHA			
	U227-11CE	10-lead cable and leads, Clip,IEC			
	KENZ PC-109				
	ECG108/110/1203/1205/601	U254-11BA		10-lead cable and leads, Banana 4.0mm,AHA	
		U254-11BE		10-lead cable and leads, Banana 4.0mm,IEC	
		U254-11DA		10-lead cable and leads, Din 3.0mm,AHA	
U254-11DE		10-lead cable and leads, Din 3.0mm,IEC			
U254-11SA		10-lead cable and leads, Snap,AHA			
U254-11SE		10-lead cable and leads, Snap,IEC			
KANZ-103, 106 Cardiline/remco:delta 1.3,30,60 delta 1 plus, Delta 3 plus,delta 60 plus	U254-11CA	10-lead cable and leads, Clip,AHA			
	U254-11CE	10-lead cable and leads, Clip,IEC			
	KENZ PC-104				
	U254-21BA	U254-21BE		10-lead cable and leads, Banana 4.0mm,IEC	
		U254-21DA		10-lead cable and leads, Din 3.0mm,AHA	
		U254-21DE		10-lead cable and leads, Din 3.0mm,IEC	
U254-21SA		10-lead cable and leads, Snap,AHA			
U254-21SE		10-lead cable and leads, Snap,IEC			
U254-21CA		10-lead cable and leads, Clip,AHA			
U254-21CE	10-lead cable and leads, Clip,IEC				
Kontron					
EKG P80	U229-11BA	10-lead cable and leads, Banana 4.0mm,AHA			
	U229-11BE	10-lead cable and leads, Banana 4.0mm,IEC			
	U229-11DA	10-lead cable and leads, Din 3.0mm,AHA			
	U229-11DE	10-lead cable and leads, Din 3.0mm,IEC			
	U229-11SA	10-lead cable and leads, Snap,AHA			
	U229-11SE	10-lead cable and leads, Snap,IEC			
U229-11CA	U229-11CE	10-lead cable and leads, Clip,AHA			
	U229-11CE	10-lead cable and leads, Clip,IEC			

Compatible Model	P/N	Description	Image		
Medtronic Physio-Control					
Lifepak 12, Lifepark20,	U273-11BA	10-lead cable and leads, Banana 4.0mm,AHA			
	U273-11BE	10-lead cable and leads, Banana 4.0mm,IEC			
	U273-11DA	10-lead cable and leads, Din 3.0mm,AHA			
	U273-11DE	10-lead cable and leads, Din 3.0mm,IEC			
	U273-11SA	10-lead cable and leads, Snap,AHA			
	U273-11SE	10-lead cable and leads, Snap,IEC			
Mindray	U273-11CA	10-lead cable and leads, Clip,AHA			
	U273-11CE	10-lead cable and leads, Clip,IEC			
	U203-11BA	10-lead cable and leads, Banana 4.0mm,AHA			
	U203-11BE	10-lead cable and leads, Banana 4.0mm,IEC			
	U203-11DA	10-lead cable and leads, Din 3.0mm,AHA			
	U203-11DE	10-lead cable and leads, Din 3.0mm,IEC			
U203-11SA	10-lead cable and leads, Snap,AHA				
U203-11SE	10-lead cable and leads, Snap,IEC				
Beneview 12-Ld Module	U203-11CA	10-lead cable and leads, Clip,AHA			
	U203-11CE	10-lead cable and leads, Clip,IEC			
	Mindray				
	R12	U203-21BA		10-lead cable and leads, Banana 4.0mm,AHA	
		U203-21BE		10-lead cable and leads, Banana 4.0mm,IEC	
		U203-21DA		10-lead cable and leads, Din 3.0mm,AHA	
U203-21DE		10-lead cable and leads, Din 3.0mm,IEC			
U203-21SA		10-lead cable and leads, Snap,AHA			
U203-21SE		10-lead cable and leads, Snap,IEC			
Mindray	U203-21CA	10-lead cable and leads, Clip,AHA			
	U203-21CE	10-lead cable and leads, Clip,IEC			
	Mindray				
	R3	U203-31BA		10-lead cable and leads, Banana 4.0mm,AHA	
		U203-31BE		10-lead cable and leads, Banana 4.0mm,IEC	
		U203-31DA		10-lead cable and leads, Din 3.0mm,AHA	
U203-31DE		10-lead cable and leads, Din 3.0mm,IEC			
U203-31SA		10-lead cable and leads, Snap,AHA			
U203-31SE		10-lead cable and leads, Snap,IEC			
Mindray	U203-31CA	10-lead cable and leads, Clip,AHA			
	U203-31CE	10-lead cable and leads, Clip,IEC			
	Mortara				
	Mortara Instrument: Eli 100, Eli200, Eli 50	U257-11BA		10-lead cable and leads, Banana 4.0mm,AHA	
		U257-11BE		10-lead cable and leads, Banana 4.0mm,IEC	
		U257-11DA		10-lead cable and leads, Din 3.0mm,AHA	
U257-11DE		10-lead cable and leads, Din 3.0mm,IEC			
U257-11SA		10-lead cable and leads, Snap,AHA			
U257-11SE		10-lead cable and leads, Snap,IEC			
Mortara	U257-11CA	10-lead cable and leads, Clip,AHA			
	U257-11CE	10-lead cable and leads, Clip,IEC			
	Mortara	U257-21BA		10-lead cable and leads, Banana 4.0mm,AHA	
		U257-21BE		10-lead cable and leads, Banana 4.0mm,IEC	
		U257-21DA		10-lead cable and leads, Din 3.0mm,AHA	
		U257-21DE		10-lead cable and leads, Din 3.0mm,IEC	
U257-21SA		10-lead cable and leads, Snap,AHA			
U257-21SE		10-lead cable and leads, Snap,IEC			
ELI 10, 150, 210, 250	U257-21CA	10-lead cable and leads, Clip,AHA			
	U257-21CE	10-lead cable and leads, Clip,IEC			
	Nihon Kohden				
	ECG-9620/9010/9020, ECG-9022/9110/9130/9132 (without resistor)	U205-11BA		10-lead cable and leads, Banana 4.0mm,AHA	
		U205-11BE		10-lead cable and leads, Banana 4.0mm,IEC	
		U205-11DA		10-lead cable and leads, Din 3.0mm,AHA	
U205-11DE		10-lead cable and leads, Din 3.0mm,IEC			
U205-11SA		10-lead cable and leads, Snap,AHA			
U205-11SE		10-lead cable and leads, Snap,IEC			
Nihon Kohden	U205-11CA	10-lead cable and leads, Clip,AHA			
	U205-11CE	10-lead cable and leads, Clip,IEC			
	Nihon Kohden				
	Cardiofax 6151/6353, cardi ofax EKG-8270/8350/8370/8420/8423/8450/8453/8820/8823/8830/9130, Cardiofax-Q (4.7KΩ resistor)	U205-21BA		10-lead cable and leads, Banana 4.0mm,AHA	
		U205-21BE		10-lead cable and leads, Banana 4.0mm,IEC	
		U205-21DA		10-lead cable and leads, Din 3.0mm,AHA	
U205-21DE		10-lead cable and leads, Din 3.0mm,IEC			
U205-21SA		10-lead cable and leads, Snap,AHA			
U205-21SE		10-lead cable and leads, Snap,IEC			
Nihon Kohden	U205-21CA	10-lead cable and leads, Clip,AHA			
	U205-21CE	10-lead cable and leads, Clip,IEC			
	Nihon Kohden				
	ECG-9320	U205-31BA		10-lead cable and leads, Banana 4.0mm,AHA	
		U205-31BE		10-lead cable and leads, Banana 4.0mm,IEC	
		U205-31DA		10-lead cable and leads, Din 3.0mm,AHA	
U205-31DE		10-lead cable and leads, Din 3.0mm,IEC			
U205-31SA		10-lead cable and leads, Snap,AHA			
U205-31SE		10-lead cable and leads, Snap,IEC			
Nihon Kohden	U205-31CA	10-lead cable and leads, Clip,AHA			
	U205-31CE	10-lead cable and leads, Clip,IEC			





Compatible Model	P/N	Description	Image		
Nihon Kohden					
BJ-900P	U205-41BA	10-lead cable and leads, Banana 4.0mm,AHA			
	U205-41BE	10-lead cable and leads, Banana 4.0mm,IEC			
	U205-41DA	10-lead cable and leads, Din 3.0mm,AHA			
	U205-41DE	10-lead cable and leads, Din 3.0mm,IEC			
	U205-41SA	10-lead cable and leads, Snap,AHA			
	U205-41SE	10-lead cable and leads, Snap,IEC			
Nihon Kohden	U205-41CA	10-lead cable and leads, Clip,AHA			
	U205-41CE	10-lead cable and leads, Clip,IEC			
	Nihon Kohden				
	(10KΩ resistor)	U205-51BA		10-lead cable and leads, Banana 4.0mm,AHA	
		U205-51BE		10-lead cable and leads, Banana 4.0mm,IEC	
		U205-51DA		10-lead cable and leads, Din 3.0mm,AHA	
U205-51DE		10-lead cable and leads, Din 3.0mm,IEC			
U205-51SA		10-lead cable and leads, Snap,AHA			
U205-51SE		10-lead cable and leads, Snap,IEC			
Philips	U205-51CA	10-lead cable and leads, Clip,AHA			
	U205-51CE	10-lead cable and leads, Clip,IEC			
	Philips				
	M1770A pagewriter 200I, M1771A pagewriter 200, M1772A pagewriter 100. (20KΩ resistor)	U204-11BA		10-lead cable and leads, Banana 4.0mm,AHA	
		U204-11BE		10-lead cable and leads, Banana 4.0mm,IEC	
		U204-11DA		10-lead cable and leads, Din 3.0mm,AHA	
U204-11DE		10-lead cable and leads, Din 3.0mm,IEC			
U204-11SA		10-lead cable and leads, Snap,AHA			
U204-11SE		10-lead cable and leads, Snap,IEC			
Philips	U204-11CA	10-lead cable and leads, Clip,AHA			
	U204-11CE	10-lead cable and leads, Clip,IEC			
	Philips				
	(10KΩ resistor)	U204-21BA		10-lead cable and leads, Banana 4.0mm,AHA	
		U204-21BE		10-lead cable and leads, Banana 4.0mm,IEC	
		U204-21DA		10-lead cable and leads, Din 3.0mm,AHA	
U204-21DE		10-lead cable and leads, Din 3.0mm,IEC			
U204-21SA		10-lead cable and leads, Snap,AHA			
U204-21SE		10-lead cable and leads, Snap,IEC			
Schiller	U204-21CA	10-lead cable and leads, Clip,AHA			
	U204-21CE	10-lead cable and leads, Clip,IEC			
	Schiller				
	Schiller:AT1, AT2, AT3, AT4, AT5, AT6, AT10, AT60 AT104PC, AT104, AT101, AT102, CS100, CS6, CS6/12 (10KΩ resistor)	U225-11BA		10-lead cable and leads, Banana 4.0mm,AHA	
		U225-11BE		10-lead cable and leads, Banana 4.0mm,IEC	
		U225-11DA		10-lead cable and leads, Din 3.0mm,AHA	
U225-11DE		10-lead cable and leads, Din 3.0mm,IEC			
U225-11SA		10-lead cable and leads, Snap,AHA			
U225-11SE		10-lead cable and leads, Snap,IEC			
Schiller	U225-11CA	10-lead cable and leads, Clip,AHA			
	U225-11CE	10-lead cable and leads, Clip,IEC			
	Schiller				
	(without resistor)	U225-21BA		10-lead cable and leads, Banana 4.0mm,AHA	
		U225-21BE		10-lead cable and leads, Banana 4.0mm,IEC	
		U225-21DA		10-lead cable and leads, Din 3.0mm,AHA	
U225-21DE		10-lead cable and leads, Din 3.0mm,IEC			
U225-21SA		10-lead cable and leads, Snap,AHA			
U225-21SE		10-lead cable and leads, Snap,IEC			
Shanghai Kohden	U225-21CA	10-lead cable and leads, Clip,AHA			
	U225-21CE	10-lead cable and leads, Clip,IEC			
	Shanghai Kohden				
	ECG- 6511, 6151, 6551, 8110PK, 6353, 6403, 6504	U244-11BA		10-lead cable and leads, Banana 4.0mm,AHA	
		U244-11BE		10-lead cable and leads, Banana 4.0mm,IEC	
		U244-11DA		10-lead cable and leads, Din 3.0mm,AHA	
U244-11DE		10-lead cable and leads, Din 3.0mm,IEC			
U244-11SA		10-lead cable and leads, Snap,AHA			
U244-11SE		10-lead cable and leads, Snap,IEC			
Shanghai Kohden	U244-11CA	10-lead cable and leads, Clip,AHA			
	U244-11CE	10-lead cable and leads, Clip,IEC			
	Shanghai Kohden				
	ECG-2350, BJ-901D (33KΩ resistor)	U244-21BA		10-lead cable and leads, Banana 4.0mm,AHA	
		U244-21BE		10-lead cable and leads, Banana 4.0mm,IEC	
		U244-21DA		10-lead cable and leads, Din 3.0mm,AHA	
U244-21DE		10-lead cable and leads, Din 3.0mm,IEC			
U244-21SA		10-lead cable and leads, Snap,AHA			
U244-21SE		10-lead cable and leads, Snap,IEC			
Welch Allyn	U244-21CA	10-lead cable and leads, Clip,AHA			
	U244-21CE	10-lead cable and leads, Clip,IEC			
	Welch Allyn				
	(10KΩ resistor)	U261-11BA		10-lead cable and leads, Banana 4.0mm,AHA	
		U261-11BE		10-lead cable and leads, Banana 4.0mm,IEC	
		U261-11DA		10-lead cable and leads, Din 3.0mm,AHA	
U261-11DE		10-lead cable and leads, Din 3.0mm,IEC			
U261-11SA		10-lead cable and leads, Snap,AHA			
U261-11SE		10-lead cable and leads, Snap,IEC			
Welch Allyn	U261-11CA	10-lead cable and leads, Clip,AHA			
	U261-11CE	10-lead cable and leads, Clip,IEC			











Compatible Model	P/N	Description	Image		
Welch Allyn					
CP50	U261-21BA	10-lead cable and leads, Banana 4.0mm,AHA			
	U261-21BE	10-lead cable and leads, Banana 4.0mm,IEC			
	U261-21DA	10-lead cable and leads, Din 3.0mm,AHA			
	U261-21DE	10-lead cable and leads, Din 3.0mm,IEC			
	U261-21SA	10-lead cable and leads, Snap,AHA			
	U261-21SE	10-lead cable and leads, Snap,IEC			
Zoll	U261-21CA	10-lead cable and leads, Clip,AHA			
	U261-21CE	10-lead cable and leads, Clip,IEC			
	Zoll				
	Zoll M series	U247-11BA		10-lead cable and leads, Banana 4.0mm,AHA	
		U247-11BE		10-lead cable and leads, Banana 4.0mm,IEC	
		U247-11DA		10-lead cable and leads, Din 3.0mm,AHA	
U247-11DE		10-lead cable and leads, Din 3.0mm,IEC			
U247-11SA		10-lead cable and leads, Snap,AHA			
U247-11SE		10-lead cable and leads, Snap,IEC			
Zoll	U247-11CA	10-lead cable and leads, Clip,AHA			
	U247-11CE	10-lead cable and leads, Clip,IEC			
	Multi-link EKG Trunk Cable				
	Burdick	U245-22GA		10 lead EKG trunk cable, 15M>VS 10L yoke, 2.2m,AHA	
		U245-22GE		10 lead EKG trunk cable, 15M>VS 1	

Compatible Model	P/N	Description	Image
GE CAM14 Original Part No:420101-001	U202-33GE	14-lead leadwires	
GE	U202-14A	GE CAM14 Data Cable	
Mortara Eli 230	U257-23BA	10-lead wires,Banana 4.0mm,AHA	
	U257-23BE	10-lead wires,Banana 4.0mm,IEC	
	U257-23DA	10-lead wires,Din 3.0mm,AHA	
	U257-23DE	10-lead wires,Din 3.0mm,IEC	
	U257-23SA	10-lead wires,Snap,AHA	
	U257-23SE	10-lead wires,Snap,IEC	
	U257-23CA	10-lead wires,Clip,AHA	
Philips M1700A,M1701A, M1702A,Trim II,Trim 1, Trim 2,Trim 3.	U204-13BA	10-lead wires,Banana 4.0mm,AHA	
	U204-13BE	10-lead wires,Banana 4.0mm,IEC	
	U204-13DA	10-lead wires,Din 3.0mm,AHA	
	U204-13DE	10-lead wires,Din 3.0mm,IEC	
	U204-13SA	10-lead wires,Snap,AHA	
	U204-13SE	10-lead wires,Snap,IEC	
	U204-13CA	10-lead wires,Clip,AHA	
Philips TC30,TC50,TC60	U204-23BA	10-lead wires,Banana 4.0mm,AHA	
	U204-23BE	10-lead wires,Banana 4.0mm,IEC	
	U204-23DA	10-lead wires,Din 3.0mm,AHA	
	U204-23DE	10-lead wires,Din 3.0mm,IEC	
	U204-23SA	10-lead wires,Snap,AHA	
	U204-23SE	10-lead wires,Snap,IEC	
	U204-23CA	10-lead wires,Clip,AHA	
U204-23CE	10-lead wires,Clip,IEC		







Compatible Model	P/N	Description	Image
Philips M1602A M1604A M1976A M1978A	U204-33BA	10-lead wires,Banana 4.0mm,AHA	
	U204-33BE	10-lead wires,Banana 4.0mm,IEC	
	U204-33DA	10-lead wires,Din 3.0mm,AHA	
	U204-33DE	10-lead wires,Din 3.0mm,IEC	
	U204-33SA	10-lead wires,Snap,AHA	
	U204-33SE	10-lead wires,Snap,IEC	
	U204-33CA	10-lead wires,Clip,AHA	
Philips TC30,TC50	U204-33CE	10-lead wires,Clip,IEC	
	U204-14A	Philips Data Cable	
	U204-24A	Philips trim USB-6P	
Spacelabs	U207-13SA	10-lead wires,Snap,AHA	
	U207-13SE	10-lead wires,Snap,IEC	
	U207-13CA	10-lead wires,Clip,AHA	
	U207-13CE	10-lead wires,Clip,IEC	
Welch Allyn CP100,CP200	U261-13BA	10-lead wires,Banana 4.0mm,AHA	
	U261-13BE	10-lead wires,Banana 4.0mm,IEC	
	U261-13DA	10-lead wires,Din 3.0mm,AHA	
	U261-13DE	10-lead wires,Din 3.0mm,IEC	
	U261-13SA	10-lead wires,Snap,AHA	
	U261-13SE	10-lead wires,Snap,IEC	
	U261-13CA	10-lead wires,Clip,AHA	
U261-13CE	10-lead wires,Clip,IEC		

EKG Accessories Suction chest and Limb Clamp ECG Electrodes









P/N	Description	Package	Image
U901-1AA	Normal EKG Suction Electrode,Adult fit for Banana 4.0mm & Din 3.0mm plug Color: Grey Nickel-plate	6pcs/set	
U901-1AB	Normal Adult EKG Suction Electrode,Adult fit for Banana 4.0mm & Din 3.0mm plug Color: Grey Ag/AgCl	6pcs/set	
U901-1BA	Multi-functional Suction Electrode,Adult fit for Banana 4.0mm,Din 3.0mm,Snap & Clip plug, Color: Blue Nickel-plate	6pcs/set	
U901-1BB	Multi-functional Suction Electrode,Adult fit for Banana 4.0mm,Din 3.0mm,Snap & Clip plug, Color: Blue Ag/AgCl	6pcs/set	

P/N	Description	Package	Image
U901-1CA	Multi-functional Suction Electrode,Child fit for Banana 4.0mm,Din 3.0mm,Snap & Clip plug, Color: Blue Nickel-plate	6pcs/set	
U901-1CB	Multi-functional Suction Electrode,Child fit for Banana 4.0mm,Din 3.0mm,Snap & Clip plug, Color: Blue Ag/AgCl	6pcs/set	
U901-1DA	Multi-functional Suction Electrode, Extra Adult fit for Banana 4.0mm,Din 3.0mm,Snap & Clip plug, Color: Blue Nickel-plate	6pcs/set	
U901-1DB	Multi-functional Suction Electrode, Extra Adult fit for Banana 4.0mm,Din 3.0mm,Snap & Clip plug, Color: Blue Ag/AgCl	6pcs/set	
U901-2AA	Normal Limb Clamp Electrode,Metal type,Adult fit for Banana 4.0mm & Din 3.0mm plug, Color:IEC, red(R),black(RF),green(F),yellow(L) Nickel-plate	4pcs/set	
U901-2AB	Normal Limb Clamp Electrode,Metal type,Adult fit for Banana 4.0mm & Din 3.0mm plug, Color:IEC, red(R),black(RF),green(F),yellow(L) Ag/AgCl	4pcs/set	
U901-2EA	Normal Limb Clamp Electrode,Metal type,Adult fit for Banana 4.0mm & Din 3.0mm plug, Color:AHA white(RA),black(LA),green(RL),red(LL) Nickel-plate	4pcs/set	
U901-2EB	Normal Limb Clamp Electrode,Metal type,Adult fit for Banana 4.0mm & Din 3.0mm plug, Color:AHA white(RA),black(LA),green(RL),red(LL) Ag/AgCl	4pcs/set	
U901-2BA	Multi-functional Limb Clamp Electrode,Metal type,Adult fit for Banana 4.0mm,Din 3.0mm,Snap & Clip plug, Color:IEC, red(R),black(RF),green(F),yellow(L) Nickel-plate	4pcs/set	
U901-2BB	Multi-functional Limb Clamp Electrode,Metal type,Adult fit for Banana 4.0mm,Din 3.0mm,Snap & Clip plug, Color:IEC, red(R),black(RF),green(F),yellow(L) Ag/AgCl	4pcs/set	

P/N	Description	Package	Image
U901-2FA	Multi-functional Limb Clamp Electrode,Metal type,Adult fit for Banana 4.0mm,Din 3.0mm,Snap & Clip plug, Color:AHA, white(RA),black(LA),green(RL),red(LL) Nickel-plate	4pcs/set	
U901-2FB	Multi-functional Limb Clamp Electrode,Metal type,Adult fit for Banana 4.0mm,Din 3.0mm,Snap & Clip plug, Color:AHA, white(RA),black(LA),green(RL),red(LL) Ag/AgCl	4pcs/set	
U901-2BC	Multi-functional Limb Clamp Electrode,Plastic type,Adult fit for Banana 4.0mm,Din 3.0mm,Snap & Clip plug, Color:IEC, red(R),black(RF),green(F),yellow(L) Nickel-plate	4pcs/set	
U901-2BD	Multi-functional Limb Clamp Electrode,Plastic type,Adult fit for Banana 4.0mm,Din 3.0mm,Snap & Clip plug, Color:IEC, red(R),black(RF),green(F),yellow(L) Ag/AgCl	4pcs/set	
U901-2FC	Multi-functional Limb Clamp Electrode,Plastic type,Adult fit for Banana 4.0mm,Din 3.0mm,Snap & Clip plug, Color:AHA, white(RA),black(LA),green(RL),red(LL) Nickel-plate	4pcs/set	
U901-2FD	Multi-functional Limb Clamp Electrode,Plastic type,Adult fit for Banana 4.0mm,Din 3.0mm,Snap & Clip plug, Color:AHA, white(RA),black(LA),green(RL),red(LL) Ag/AgCl	4pcs/set	
U901-2CC	Multi-functional Limb Clamp Electrode,Plastic type,Child fit for Banana 4.0mm,Din 3.0mm,Snap & Clip plug, Color:IEC, red(R),black(RF),green(F),yellow(L) Nickel-plate	4pcs/set	
U901-2CD	Multi-functional Limb Clamp Electrode,Plastic type,Child fit for Banana 4.0mm,Din 3.0mm,Snap & Clip plug, Color:IEC, red(R),black(RF),green(F),yellow(L) Ag/AgCl	4pcs/set	
U901-3AA	Normal EKG Suction Electrode,Adult fit for Banana 4.0mm & Din 3.0mm plug Color: red,yellow,green,orange,blue,purple Nickel-plate	6pcs/set	
U901-3AB	Multi-functional Suction Electrode,Adult fit for Banana 4.0mm,Din 3.0mm,Snap & Clip plug, Color: red,yellow,green,orange,blue,purple Ag/AgCl	6pcs/set	

P/N	Description	Package	Image
U901-3BA	Normal EKG Suction Electrode,Adult fit for Banana 4.0mm & Din 3.0mm plug Color: red,yellow,green,orange,blue,purple Nickel-plate	6pcs/set	
U901-3BB	Multi-functional Suction Electrode,Adult fit for Banana 4.0mm,Din 3.0mm,Snap & Clip plug, Color: red,yellow,green,orange,blue,purple Ag/AgCl	6pcs/set	
EKG Adapter			
U903-1AA	Banana 4.0mm to Snap end,without wire	10pcs/set	
U903-1BA	Banana 4.0mm to Clip end,without wire	10pcs/set	
U903-1AB	Din 3.0mm to Snap end,without wire	10pcs/set	
U903-1BB	Din 3.0mm to Clip end,without wire	10pcs/set	
U903-1BH	4.00mm Adapter Clip Connector,AHA	10pcs/set	
U903-1BJ	4.00mm Adapter Clip Connector,IEC	10pcs/set	
U903-1BL	4.00mm Adapter Clip Connector,AHA	14pcs/set	
U903-1BK	4.00mm Adapter Clip Connector,IEC	14pcs/set	
U903-1EH	4.00mm Adapter Banana Connector,AHA	10pcs/set	
U903-1EJ	4.00mm Adapter Banana Connector,IEC	10pcs/set	
U903-1EL	4.00mm Adapter Banana Connector,AHA	14pcs/set	
U903-1EK	4.00mm Adapter Banana Connector,IEC	14pcs/set	

P/N	Description	Package	Image
U903-2AA	Banana 4.0mm to Snap end,with wire,20cm,IEC	10pcs/set	
U903-2BA	Banana 4.0mm to Clip end,with wire,20cm,IEC	10pcs/set	
U903-2AB	Din 3.0mm to Snap end,with wire,20cm,IEC	10pcs/set	
U903-2BB	Din 3.0mm to Clip end,with wire,20cm,IEC	10pcs/set	
U903-2AC	Banana 4.0mm to Snap end,with wire,20cm,AHA	10pcs/set	
U903-2BC	Banana 4.0mm to Clip end,with wire,20cm,AHA	10pcs/set	
U903-2AD	Din 3.0mm to Snap end,with wire,20cm,AHA	10pcs/set	
U903-2BD	Din 3.0mm to Clip end,with wire,20cm,AHA	10pcs/set	
U903-3CA	Banana 4.0mm to disposable ecg electrodes	10pcs/set	
U903-3CB	Din 3.0mm to disposable ecg electrodes	10pcs/set	
U903-3CG	Multi-function adapter Connector	10pcs/set	
U903-4BA	Alligator Clip,red color,square connector	10pcs/set	
U903-4BG	Multi-function Animal Clip	5pcs/set	
U903-4BF	Animal Clip	5pcs/set	
U903-4DA	Alligator Clip,round connector	10pcs/set	

Brand/Compatible model	P/N	Description	Image
Biocare(19-Pin)	U146-1110SA	HDMI Holter 10-lead leadwires,Snap,AHA	
	U146-1110SE	HDMI Holter 10-lead leadwires,Snap,IEC	
	U146-1110CA	HDMI Holter 10-lead leadwires,Clip,AHA	
	U146-1110CE	HDMI Holter 10-lead leadwires,Clip,IEC	
Burdick 92513 Holter (PCB 7pins)	U145-12A7A	Burdick Holter 7-lead Trunk cable,AHA (suitable for DIN 1.5mm lead wires)	
	U145-12A7E	Burdick Holter 7-lead Trunk cable,IEC (suitable for DIN 1.5mm lead wires)	
BI(26-Pin)	U1108-115SA	BI Holter 5-lead wires, Snap, AHA	
	U1108-115SE	BI Holter 5-lead wires, Snap, IEC	
BI(26-Pin)	U1108-117SA	BI Holter 7-lead wires, Snap, AHA	
	U1108-117SE	BI Holter 7-lead wires, Snap, IEC	
BI BI-9800 Holter(26-Pin)	U1108-1110SA	BI Holter 10-lead wires, Snap, AHA	
	U1108-1110SE	BI Holter 10-lead wires, Snap, IEC	
BI(14-Pin)	U1108-2110SA	BI Holter 10-lead wires, Snap, AHA	
	U1108-2110SE	BI Holter 10-lead wires, Snap, IEC	
DIN 1.5mm jack	U101-3A3SA	Din 1.5mm 3-lead wires,Snap,AHA	
	U101-3A3SE	Din 1.5mm 3-lead wires,Snap,IEC	
	U101-3A3CA	Din 1.5mm 3-lead wires,Clip,AHA	
	U101-3A3CE	Din 1.5mm 3-lead wires,Clip,IEC	
	U101-3A5SA	Din 1.5mm 5-lead wires,Snap,AHA	
	U101-3A5SE	Din 1.5mm 5-lead wires,Snap,IEC	
	U101-3A5CA	Din 1.5mm 5-lead wires,Clip,AHA	
	U101-3A5CE	Din 1.5mm 5-lead wires,Clip,IEC	

Brand/Compatible model	P/N	Description	Image
DIN 1.5mm jack	U101-3A7SA	Din 1.5mm 7-lead wires, Snap, AHA	
	U101-3A7SE	Din 1.5mm 7-lead wires, Snap, IEC	
	U101-3A7CA	Din 1.5mm 7-lead wires, Clip, AHA	
	U101-3A7CE	Din 1.5mm 7-lead wires, Clip, IEC	
	U101-3A10SA	Din 1.5mm 10-lead wires, Snap, AHA	
	U101-3A10SE	Din 1.5mm 10-lead wires, Snap, IEC	
	U101-3A10CA	Din 1.5mm 10-lead wires, Clip, AHA	
	U101-3A10CE	Din 1.5mm 10-lead wires, Clip, IEC	
DIN 2.0mm jack	U101-3B3SA	Din 2.0mm 3-lead wires, Snap, AHA	
	U101-3B3SE	Din 2.0mm 3-lead wires, Snap, IEC	
	U101-3B3CA	Din 2.0mm 3-lead wires, Clip, AHA	
	U101-3B3CE	Din 2.0mm 3-lead wires, Clip, IEC	
	U101-3B5SA	Din 2.0mm 5-lead wires, Snap, AHA	
	U101-3B5SE	Din 2.0mm 5-lead wires, Snap, IEC	
	U101-3B5CA	Din 2.0mm 5-lead wires, Clip, AHA	
	U101-3B5CE	Din 2.0mm 5-lead wires, Clip, IEC	
	U101-3B7SA	Din 2.0mm 7-lead wires, Snap, AHA	
	U101-3B7SE	Din 2.0mm 7-lead wires, Snap, IEC	
	U101-3B7CA	Din 2.0mm 7-lead wires, Clip, AHA	
	U101-3B7CE	Din 2.0mm 7-lead wires, Clip, IEC	
	U101-3B10SA	Din 2.0mm 10-lead wires, Snap, AHA	
	U101-3B10SE	Din 2.0mm 10-lead wires, Snap, IEC	
	U101-3B10CA	Din 2.0mm 10-lead wires, Clip, AHA	
	U101-3B10CE	Din 2.0mm 10-lead wires, Clip, IEC	

D~D

Brand/Compatible model	P/N	Description	Image
Earphone connector (3.5)	U165-13SA	3-lead ECG Cable with leadwires, Snap, AHA	
	U165-13SE	3-lead ECG Cable with leadwires, Snap, IEC	
	U165-13CA	3-lead ECG Cable with leadwires, Clip, AHA	
	U165-13CE	3-lead ECG Cable with leadwires, Clip, IEC	
Earphone connector (2.5)	U165-23SA	3-lead ECG Cable with leadwires, Snap, AHA	
	U165-23SE	3-lead ECG Cable with leadwires, Snap, IEC	
	U165-23CA	3-lead ECG Cable with leadwires, Clip, AHA	
	U165-23CE	3-lead ECG Cable with leadwires, Clip, IEC	
Edan(26-Pin)	U172-1110SA	Edan Holter 10-lead wires, Snap, AHA	
	U172-1110SE	Edan Holter 10-lead wires, Snap, IEC	
Edan SE-2003/SE-2012 (26-Pin)	U172-117SA	Edan Holter 7-lead wires, Snap, AHA	
	U172-117SE	Edan Holter 7-lead wires, Snap, IEC	
Edan(16-Pin)	U172-2110SA	Edan Holter 10-lead wires, Snap, AHA	
	U172-2110SE	Edan Holter 10-lead wires, Snap, IEC	
GE Dynamic (12-Pin)	U102-1110SA	GE Holter 10-lead wires, Snap, AHA	
	U102-1110SE	GE Holter 10-lead wires, Snap, IEC	
GE Seer Light(16-Pin)	U102-215SA	GE Holter 5-lead wires, Snap, AHA	
	U102-215SE	GE Holter 5-lead wires, Snap, IEC	
	U102-217SA	GE Holter 7-lead wires, Snap, AHA	
	U102-217SE	GE Holter 7-lead wires, Snap, IEC	
HDMI(19-Pin)	U142-1110SA	Holter 10-lead wires, Snap, AHA	
	U142-1110SE	Holter 10-lead wires, Snap, IEC	

E~H

Brand/Compatible model	P/N	Description	Image
HDMI(19-Pin)	U142-117SE	Holter 7-lead wires, snap, IEC	
	U142-117SA	Holter 7-lead wires, snap, AHA	
	U142-115SA	Holter 5-lead wires, snap, AHA	
	U142-115SE	Holter 5-lead wires, snap, IEC	
M&B(7-Pin)	U117-113SA	M&B Holter 3-lead wires, Snap, AHA	
	U117-113SE	M&B Holter 3-lead wires, Snap, IEC	
Meigaoyi	U1125-1110SA	Meigaoyi Holter 10-lead wires, Snap, AHA	
	U1125-1110SE	Meigaoyi Holter 10-lead wires, Snap, IEC	
Mindray Telemetry (7-Pin)	U103-113SA	Mindray Holter 3-lead wires, Snap, AHA	
	U103-113SE	Mindray Holter 3-lead wires, Snap, IEC	
Mindray (7-Pin)	U103-213SA	Mindray Holter 3-lead wires, Snap, AHA	
	U103-213SE	Mindray Holter 3-lead wires, Snap, IEC	
Mindray Telemetry (7-Pin)	U103-315SA	Mindray Holter 5-lead wires, Snap, AHA	
	U103-315SE	Mindray Holter 5-lead wires, Snap, IEC	
Mindray(Old type)(10-Pin)	U103-415CA	Mindray Holter 5-lead wires, Snap, AHA	
	U103-415CE	Mindray Holter 5-lead wires, Snap, IEC	
	U103-415SA	Mindray Holter 5-lead wires, Clip, AHA	
	U103-415SE	Mindray Holter 5-lead wires, Clip, IEC	
Mortara	U157-1110SA	Mortara Holter 10-lead wires, Snap, AHA	
	U157-1110SE	Mortara Holter 10-lead wires, Snap, IEC	
	U157-215SA	Mortara Holter 5-lead wires, Snap, AHA	
	U157-215SE	Mortara Holter 5-lead wires, Snap, IEC	

Brand/Compatible model	P/N	Description	Image
Nihon Kohden(26-Pin)	U105-117SA	Holter 7-lead wires ,snap, AHA	
	U105-117SE	Holter 7-lead wires ,snap, IEC	
Nihon Kohden(26-Pin)	U105-1110SA	Nihon Kohden Holter 10-lead wires, Snap, AHA	
	U105-1110SE	Nihon Kohden Holter 10-lead wires, Snap, IEC	
JincoMed(3.5mm Screw)	U1109-4110SA	Holter 10-lead wires,snap, AHA	
	U1109-4110SE	Holter 10-lead wires,snap, IEC	
JincoMed(14-Pin)	U1109-1110SA	JincoMed Holter 10-lead wires, Snap, AHA	
	U1109-1110SE	JincoMed Holter 10-lead wires, Snap, IEC	
JincoMed(5.2mm Screw)	U1109-2110SA	JincoMed Holter 10-lead wires, Snap, AHA	
	U1109-2110SE	JincoMed Holter 10-lead wires, Snap, IEC	
JincoMed 3000(14-Pin)	U1109-3110SA	JincoMed Holter 10-lead wires, Snap, AHA	
	U1109-3110SE	JincoMed Holter 10-lead wires, Snap, IEC	
Philips Digitrak XT(11-Pin)	U104-115SA	Holter 5-lead wires, Snap, AHA	
	U104-115SE	Holter 5-lead wires, Snap, IEC	
PI(15-Pin)	U1110-2110SA	Holter 10-lead wires, snap, AHA	
	U1110-2110SE	Holter 10-lead wires, snap, IEC	
PI(4-Pin,6-Pin)	U1110-114SA	Holter 4-lead wires, Snap, AHA	
	U1110-116SE	Holter 6-lead wires, Snap, IEC	



NIBP Hose&Cuff&Connector

U500-1AC

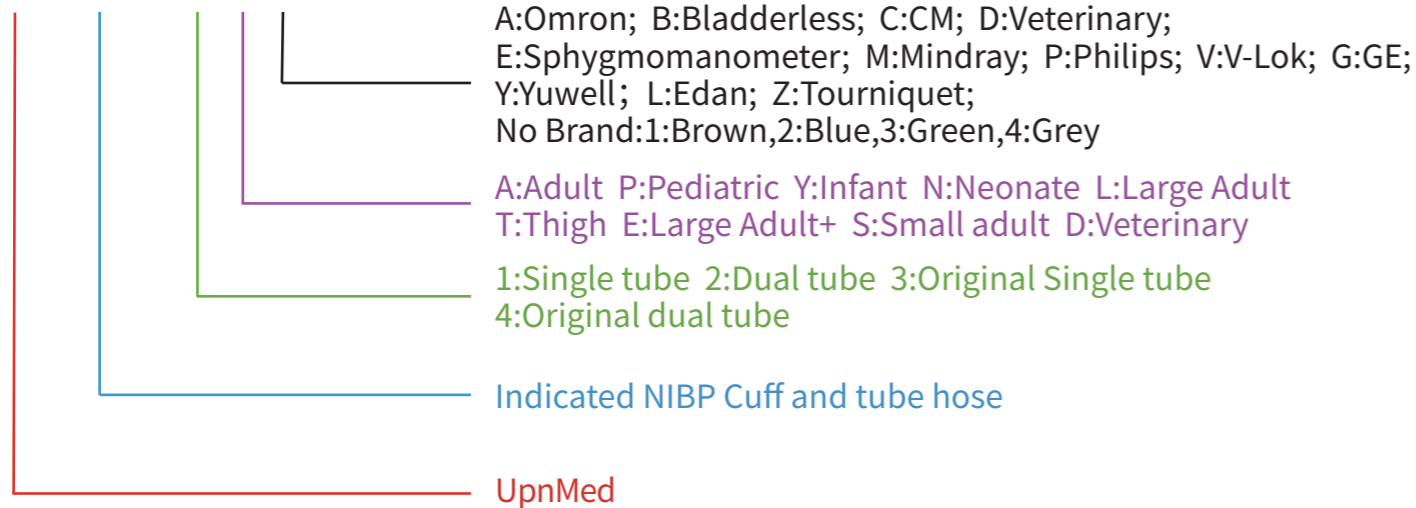

For example: U500-1A(1)Brown colour Adult NIBP Cuff single tube
U500-1A(C)CM Adult NIBP Cuff single tube

P/N	Description	Image
U500-1T(U)	Adult Thigh Single NIBP Cuff with bladder,TPU,46-66CM	
U500-2T(U)	Adult Thigh Dual NIBP Cuff with bladder,TPU,46-66CM	
U500-1L(U)	Large Adult Single NIBP Cuff, with bladder,TPU,33-47CM	
U500-2L(U)	Large Adult Dual NIBP Cuff with bladder,TPU,33-47CM	
U500-1A(U)	Adult Single NIBP Cuff with bladder,TPU,27-35CM	
U500-2A(U)	Adult Dual NIBP Cuff with bladder,TPU,27-35CM	
U500-1P(U)	Child Single NIBP Cuff with bladder,TPU,18-26CM	
U500-2P(U)	Child Dual NIBP Cuff with bladder,TPU,18-26CM	
U500-1Y(U)	Infant Single NIBP Cuff with bladder,TPU,10-19CM	
U500-2Y(U)	Infant Dual NIBP Cuff with bladder,TPU,10-19CM	
U500-1N(U)	Neonate Single NIBP Cuff with bladder,TPU,7-13CM	
U500-2N(U)	Neonate Dual NIBP Cuff with bladder,TPU,7-13CM	
U500-1T(C)	CM Adult Thigh Single NIBP Cuff with bladder,TPU,46-66CM	
U500-2T(C)	CM Adult Thigh Dual NIBP Cuff with bladder,TPU,46-66CM	
U500-1L(C)	CM Large Adult Single NIBP Cuff, with bladder,TPU,33-47CM	
U500-2L(C)	CM Large Adult Dual NIBP Cuff with bladder,TPU,33-47CM	
U500-1A(C)	CM Adult Single NIBP Cuff with bladder,TPU,25-35CM	
U500-2A(C)	CM Adult Dual NIBP Cuff with bladder,TPU,25-35CM	
U500-1P(C)	CM Child Single NIBP Cuff with bladder,TPU,18-26CM	
U500-2P(C)	CM Child Dual NIBP Cuff with bladder,TPU,18-26CM	
U500-1Y(C)	CM Infant Single NIBP Cuff with bladder,TPU,10-19CM / 12-19CM	
U500-2Y(C)	CM Infant Dual NIBP Cuff with bladder,TPU,10-19CM / 12-19CM	
U500-1N(C)	CM Neonate Single NIBP Cuff with bladder,TPU,6-11CM	
U500-2N(C)	CM Neonate Dual NIBP Cuff with bladder,TPU,6-11CM	
U500-1A(V)	V-lok Adult Single NIBP Cuff with bladder,TPU,25-35CM	
U500-2A(V)	V-lok Adult Dual NIBP Cuff with bladder,TPU,25-35CM	
U500-1P(V)	V-lok Child Single NIBP Cuff with bladder,TPU,18-26CM	
U500-2P(V)	V-lok Child Dual NIBP Cuff with bladder,TPU,18-26CM	
U500-1Y(V)	V-lok Infant Single NIBP Cuff with bladder,TPU,10-19CM	
U500-2Y(V)	V-lok Infant Dual NIBP Cuff with bladder,TPU,10-19CM	
U500-1N(V)	V-lok Neonate Single NIBP Cuff with bladder,TPU,6-11CM	
U500-2N(V)	V-lok Neonate Dual NIBP Cuff with bladder,TPU,6-11CM	

P/N	Description	Image
U500-1T(P)	Philips Adult Thigh Single NIBP Cuff with bladder,TPU,42-54CM	
U500C-2T(P)	Philips Adult Thigh Dual NIBP Cuff with bladder,TPU,42-54CM	
U500-1L(P)	Philips Large Adult Single NIBP Cuff with bladder,TPU,34-43CM	
U500-2L(P)	Philips Large Adult Dual NIBP Cuff with bladder,TPU,34-43CM	
U500-1A(P)	Philips Adult Single NIBP Cuff with bladder,TPU,27-35CM	
U500-2A(P)	Philips Adult Dual NIBP Cuff with bladder,TPU,27-35CM	
U500-1S(P)	Philips Small Adult Single NIBP Cuff with bladder,TPU,20.5-28CM / 17-25CM	
U500-2S(P)	Philips Small Adult Dual NIBP Cuff with bladder,TPU,20.5-28CM / 17-25CM	
U500-1P(P)	Philips Child Single NIBP Cuff with bladder,TPU, 14-21.5CM	
U500-2P(P)	Philips Child Dual NIBP Cuff with bladder,TPU,14-21.5CM	
U500-1Y(P)	Philips Infant Single NIBP Cuff with bladder,TPU,10-19CM	
U500-2Y(P)	Philips Infant Dual NIBP Cuff with bladder,TPU,10-19CM	
U500-1N(P)	Philips Neonate Single NIBP Cuff with bladder,TPU, 6-11CM	
U500-2N(P)	Philips Neonate Dual NIBP Cuff with bladder,TPU, 6-11CM	
U500-1T(M)	Mindray Adult Thigh Single NIBP Cuff with bladder,TPU,46-66CM	
U500-2T(M)	Mindray Adult Thigh Dual NIBP Cuff with bladder,TPU,46-66CM	
U500-1L(M)	Mindray Adult large Single NIBP Cuff with bladder,TPU,33-47CM	
U500-2L(M)	Mindray Adult large Dual NIBP Cuff with bladder,TPU,33-47CM	
U500-1A(M)	Mindray Adult Single NIBP Cuff with bladder,TPU,25-35CM	
U500-2A(M)	Mindray Adult Dual NIBP Cuff with bladder,TPU,25-35CM	
U500-1P(M)	Mindray Child Single NIBP Cuff with bladder,TPU,18-26CM	
U500-2P(M)	Mindray Child Dual NIBP Cuff with bladder,TPU,18-26CM	
U500-1Y(M)	Mindray Infant Single NIBP Cuff with bladder,TPU,10-19CM / 12-19CM	
U500-2Y(M)	Mindray Infant Dual NIBP Cuff with bladder,TPU,10-19CM / 12-19CM	
U500-1N(M)	Mindray Neonate Single NIBP Cuff with bladder,TPU, 7-13CM	
U500-2N(M)	Mindray Neonate Dual NIBP Cuff with bladder,TPU, 7-13CM	
U500-1T(B)	Adult Thigh NIBP cuff,Single Tube,without bladder,46-66CM	
U500-2T(B)	Adult Thigh NIBP cuff,Dual Tube,without bladder,46-66CM	
U500-1L(B)	Large Adult NIBP cuff,Single Tube,without bladder,46-66CM/35.5-46CM/31-40CM	
U500-2L(B)	Large Adult NIBP cuff,Dual Tube,without bladder,46-66CM / 35.5-46CM / 31-40CM	
U500-1A(B)	Adult NIBP cuff,Single Tube,without bladder,25-35CM / 27.5-36.5CM	
U500-2A(B)	Adult NIBP cuff,Dual Tube,without bladder,25-35CM /27.5-36.5CM	
U500-1P(B)	Child NIBP cuff,Single Tube,without bladder,13.8-21.5CM	

P/N	Description	Image	
U500-2P(B)	Child NIBP cuff,Dual Tube,without bladder,13.8-21.5CM		
U500-1Y(B)	Infant NIBP cuff,Single Tube,without bladder,9-14.8CM		
U500-2Y(B)	Infant NIBP cuff,Dual Tube,without bladder,9-14.8CM		
U500-1N(B)	Neonate NIBP cuff,Single Tube,without bladder,6-11CM		
U500-2N(B)	Neonate NIBP cuff,Dual Tube,without bladder,6-11CM		
U500-1L(A)	Large Adult Single NIBP Cuff,with bladder,22-42CM		
U500-2L(A)	Large Adult Dual NIBP Cuff,with bladder,22-42CM		
U500-1A(A)	Adult Single NIBP Cuff,with bladder, 22-32CM		
U500-2A(A)	Adult Dual NIBP Cuff,with bladder, 22-32CM		
U500-1A(E)	Metal ring Adult NIBP cuff,Single Tube,with bladder,22-32CM		
U500-2A(E)	Metal ring Adult NIBP cuff,Dual Tube,with bladder,22-32CM		
U500-1P(E)	Metal ring Child NIBP cuff,Single Tube,with bladder,17-22CM		
U500-2P(E)	Metal ring Child NIBP cuff,Dual Tube,with bladder,17-22CM		
U500-1A(Y)	Yuwell Adult NIBP cuff,Single Tube,with bladder,22-32CM		
U500-2A(Y)	Yuwell Adult NIBP cuff,Dual Tube,with bladder,22-32CM		
U500-1P(Y)	Yuwell Child NIBP cuff,Single Tube,with bladder,17-22CM		
U500-2P(Y)	Yuwell Child NIBP cuff,Dual Tube,with bladder,17-22CM		
U500-1T(Z)	Tourniquet cuff,Adult Thigh,Single Tube,80*7.5CM		
U500-1E(Z)	Tourniquet cuff,Large Adult,Single Tube,100*12CM		
U500-1A(Z)	Tourniquet cuff,Adult,Single Tube,47*6.5CM		
U500-1S(Z)	Tourniquet cuff,Small Adult,Single Tube,37*5CM		
U500-1T(1)	Adult Thigh Single NIBP Cuff with bladder,TPU,42-54CM		
U500C-2T(1)	Adult Thigh Dual NIBP Cuff with bladder,TPU,42-54CM		
U500-1L(1)	Large Adult Single NIBP Cuff with bladder,TPU,33-43CM/35.5-46CM		
U500-2L(1)	Large Adult Dual NIBP Cuff with bladder,TPU,33-43CM/35.5-46CM		
U500-1A(1)	Adult Single NIBP Cuff with bladder,TPU,27-35CM		
U500-2A(1)	Adult Dual NIBP Cuff with bladder,TPU,27-35CM/25-35CM		
U500-1P(1)	Child Single NIBP Cuff with bladder,TPU,18-26CM		
U500-2P(1)	Child Dual NIBP Cuff with bladder,TPU,18-26CM		
U500-1Y(1)	Infant Single NIBP Cuff with bladder,TPU,10-19CM/12-19CM		
U500-2Y(1)	Infant Dual NIBP Cuff with bladder,TPU,10-19CM/12-19CM		
U500-1N(1)	Neonate Single NIBP Cuff with bladder,TPU,8-13CM		
U500-2N(1)	Neonate Dual NIBP Cuff with bladder,TPU,8-13CM		

P/N	Description	Image
U500-1T(2)	Adult Thigh Single NIBP Cuff with bladder,TPU,42-54CM	
U500-2T(2)	Adult Thigh Dual NIBP Cuff with bladder,TPU,42-54CM	
U500-1L(2)	Large Adult Single NIBP Cuff, with bladder,TPU,33-43CM/35.5-46CM	
U500-2L(2)	Large Adult Dual NIBP Cuff with bladder,TPU,33-43CM/35.5-46CM	
U500-1A(2)	Adult Single NIBP Cuff with bladder,TPU,25-35CM	
U500-2A(2)	Adult Dual NIBP Cuff with bladder,TPU,25-35CM	
U500-1P(2)	Child Single NIBP Cuff with bladder,TPU,18-26CM/12-19CM	
U500-2P(2)	Child Dual NIBP Cuff with bladder,TPU,18-26CM/12-19CM	
U500-1Y(2)	Infant Single NIBP Cuff with bladder,TPU,10-19CM/12-19CM	
U500-2Y(2)	Infant Dual NIBP Cuff with bladder,TPU,10-19CM/12-19CM	
U500-1N(2)	Neonate Single NIBP Cuff with bladder,TPU,8-13CM/6-11CM	
U500-2N(2)	Neonate Dual NIBP Cuff with bladder,TPU,8-13CM/6-11CM	
U500-D1L	Disposable Large Adult Single NIBP Cuff,35.5-46CM	
U500-D2L	Disposable Large Adult Dual NIBP Cuff,35.5-46CM	
U500-D1A	Disposable Adult Single NIBP Cuff,25-35CM	
U500-D2A	Disposable Adult Dual NIBP Cuff,25-35CM	
U500-D1P	Disposable Child Single NIBP Cuff,14-20CM	
U500-D2P	Disposable Child Dual NIBP Cuff,14-20CM	
U500-D1Y	Disposable Infant Single NIBP Cuff,9.8-13.3CM	
U500-D2Y	Disposable Infant Dual NIBP Cuff,9.8-13.3CM	
U500-D1N(1)	Disposable Neo #1 Single NIBP Cuff, 3.3-5.6CM	
U500-D2N(1)	Disposable Neo #1 Dual NIBP Cuff, 3.5-5.6CM	
U500-D1N(2)	Disposable Neo #2 Single NIBP Cuff,4.2-7.1CM	
U500-D2N(2)	Disposable Neo #2 Dual NIBP Cuff,4.2-7.1CM	
U500-D1N(3)	Disposable Neo #3 Single NIBP Cuff,5-10.5CM	
U500-D2N(3)	Disposable Neo #3 Dual NIBP Cuff,5-10.5CM	
U500-D1N(4)	Disposable Neo #4 Single NIBP Cuff,6.9-11.7CM	
U500-D2N(4)	Disposable Neo #4 Dual NIBP Cuff,6.9-11.7CM	
U500-D1N(5)	Disposable Neo #5 Single NIBP Cuff,8.9-15CM	
U500-D2N(5)	Disposable Neo #5 Dual NIBP Cuff,8.9-15CM	
U500-D1D(1)	Veterinary Disposable Neo #1 Single NIBP Cuff	
U500-D2D(1)	Veterinary Disposable Neo #1 Dual NIBP Cuff	
U500-D1D(2)	Veterinary Disposable Neo #2 Single NIBP Cuff	

P/N	Description	Image
U500-D2D(2)	Veterinary Disposable Neo #2 Dual NIBP Cuff	
U500-D1D(3)	Veterinary Disposable Neo #3 Single NIBP Cuff	
U500-D2D(3)	Veterinary Disposable Neo #3 Dual NIBP Cuff	
U500-D1D(4)	Veterinary Disposable Neo #4 Single NIBP Cuff	
U500-D2D(4)	Veterinary Disposable Neo #4 Dual NIBP Cuff	
U500-D1D(5)	Veterinary Disposable Neo #5 Single NIBP Cuff	
U500-D2D(5)	Veterinary Disposable Neo #5 Dual NIBP Cuff	
U500-D5N(1)	Disposable Neo #1 NIBP Cuff,Single Tube,PU,3.3-5.6CM	
U500-D5N(2)	Disposable Neo #2 NIBP Cuff,Single Tube,PU,4.2-7.1CM	
U500-D5N(3)	Disposable Neo #3 NIBP Cuff,Single Tube,PU,5-10.5CM	
U500-D5N(4)	Disposable Neo #4 NIBP Cuff,Single Tube,PU,6.9-11.7CM	
U500-D5N(5)	Disposable Neo #5 NIBP Cuff,Single Tube,PU,8.9-15CM	
U500-D6N(1)	Disposable Neo #1 NIBP Cuff,Dual Tube,PU,3.3-5.6CM	
U500-D6N(2)	Disposable Neo #2 NIBP Cuff,Dual Tube,PU,4.2-7.1CM	
U500-D6N(3)	Disposable Neo #3 NIBP Cuff,Dual Tube,PU,5-10.5CM	
U500-D6N(4)	Disposable Neo #4 NIBP Cuff,Dual Tube,PU,6.9-11.7CM	
U500-D6N(5)	Disposable Neo #5 NIBP Cuff,Dual Tube,PU,8.9-15CM	

C~C

Compatible Brand	P/N	Description	Plug to monitor	Plug to cuff
Criticare/ Datascope/ Fukuda Denshi/ Spacelabs/ Colin/ Welch Allyn	U512-1A	Blood Pressure Interconnect Single Tube,L=2M		
	U512-1B	Blood Pressure Interconnect Single Tube,L=2M		
	U512-1C	Blood Pressure Interconnect Single Tube,L=2M		
	U512-1D	Blood Pressure Interconnect Single Tube,L=2M		
	U512-1E	Blood Pressure Interconnect Single Tube,L=2M		
	U512-1F	Blood Pressure Interconnect Single Tube,L=2M		

Compatible Brand	P/N	Description	Plug to monitor	Plug to cuff
Creative/ Omni	U510-1A	Blood Pressure Interconnect Single Tube,L=2M		
	U510-1B	Blood Pressure Interconnect Single Tube,L=2M		
	U510-1C	Blood Pressure Interconnect Single Tube,L=2M		
	U510-1D	Blood Pressure Interconnect Single Tube,L=2M		
	U510-1E	Blood Pressure Interconnect Single Tube,L=2M		
	U510-1F	Blood Pressure Interconnect Single Tube,L=2M		

Compatible Brand	P/N	Description	Plug to monitor	Plug to cuff	
Creative/ Omni	U510-1H	Blood Pressure Interconnect Single Tube,L=2M			
	U508-1A	Blood Pressure Interconnect Single Tube,L=2M			
Goldway	U508-1B	Blood Pressure Interconnect Single Tube,L=2M			
	U508-1C	Blood Pressure Interconnect Single Tube,L=2M			
	U508-1D	Blood Pressure Interconnect Single Tube,L=2M			
	U508-1E	Blood Pressure Interconnect Single Tube,L=2M			
	U508-1F	Blood Pressure Interconnect Single Tube,L=2M			
	U508-2F	Blood Pressure Interconnect Single Tube,L=2M,15B-09A			
	Mindray/ Philips/ Spacelabs/ MEK	U503-1A	Blood Pressure Interconnect Single Tube,L=2M		
		U503-1B	Blood Pressure Interconnect Single Tube,L=2M		
U503-1C		Blood Pressure Interconnect Single Tube,L=2M			
U503-1D		Blood Pressure Interconnect Single Tube,L=2M			
U503-1E		Blood Pressure Interconnect Single Tube,L=2M			
U503-1F		Blood Pressure Interconnect Single Tube,L=2M			

Compatible Brand	P/N	Description	Plug to monitor	Plug to cuff	
Mindray/ Philips/ Spacelabs/ MEK	U503-1H	Blood Pressure Interconnect Single Tube,L=2M			
	U513-1A	Blood Pressure Interconnect Single Tube,L=2M			
MEK/ Invivo	U513-1B	Blood Pressure Interconnect Single Tube,L=2M			
	U513-1C	Blood Pressure Interconnect Single Tube,L=2M			
	U513-1D	Blood Pressure Interconnect Single Tube,L=2M			
	U513-1E	Blood Pressure Interconnect Single Tube,L=2M			
	U513-1F	Blood Pressure Interconnect Single Tube,L=2M			
	U513-1J	Blood Pressure Interconnect Single Tube,L=2M			
	M&B/ Pace tech	U517-1A	Blood Pressure Interconnect Single Tube,L=2M		
		U517-1B	Blood Pressure Interconnect Single Tube,L=2M		
U517-1C		Blood Pressure Interconnect Single Tube,L=2M			
U517-1D		Blood Pressure Interconnect Single Tube,L=2M			
U517-1E		Blood Pressure Interconnect Single Tube,L=2M			
U517-1F		Blood Pressure Interconnect Single Tube,L=2M			

Compatible Brand	P/N	Description	Plug to monitor	Plug to cuff
Philips MP20, MP30	U504-1A	Blood Pressure Interconnect Single Tube,L=2M		
	U504-1B	Blood Pressure Interconnect Single Tube,L=2M		
	U504-1C	Blood Pressure Interconnect Single Tube,L=2M		
	U504-1D	Blood Pressure Interconnect Single Tube,L=2M		
	U504-1E	Blood Pressure Interconnect Single Tube,L=2M		
	U504-1F	Blood Pressure Interconnect Single Tube,L=2M		
	U504-1H	Blood Pressure Interconnect Single Tube,L=2M		
	Siemens	U515-1A	Blood Pressure Interconnect Single Tube,L=2M	
U515-1B		Blood Pressure Interconnect Single Tube,L=2M		
U515-1C		Blood Pressure Interconnect Single Tube,L=2M		
U515-1D		Blood Pressure Interconnect Single Tube,L=2M		
U515-1E		Blood Pressure Interconnect Single Tube,L=2M		
U515-1G		Blood Pressure Interconnect Single Tube,L=2M		

Compatible Brand	P/N	Description	Plug to monitor	Plug to cuff
Medtronic- Physio Control	U573-1A	Blood Pressure Interconnect Single Tube,L=2M		
	U573-1B	Blood Pressure Interconnect Single Tube,L=2M		
	U573-1C	Blood Pressure Interconnect Single Tube,L=2M		
	U573-1D	Blood Pressure Interconnect Single Tube,L=2M		
	U573-1E	Blood Pressure Interconnect Single Tube,L=2M		
	U573-1G	Blood Pressure Interconnect Single Tube,L=2M		
Welch Allyn	U561-1A	Blood Pressure Interconnect Single Tube,L=2M		
Critikon/GE/ Kontron/ Invivo	U533-1A	Blood Pressure Interconnect Dual Tube,L=2M		
	U533-1B	Blood Pressure Interconnect Dual Tube,L=2M		
	U533-1C	Blood Pressure Interconnect Dual Tube,L=2M		
	U533-1D	Blood Pressure Interconnect Dual Tube,L=2M		
GE Marquette	U502-1A	Blood Pressure Interconnect Dual Tube,L=2M		

C~M

P~G

Compatible Brand	P/N	Description	Plug to monitor	Plug to cuff
GE Marquette	U502-1B	Blood Pressure Interconnect Dual Tube,L=2M		
	U502-1C	Blood Pressure Interconnect Dual Tube,L=2M		
	U502-1D	Blood Pressure Interconnect Dual Tube,L=2M		
	U502-1E	Blood Pressure Interconnect Dual Tube,L=2M		
	U502-1G	Blood Pressure Interconnect Dual Tube,L=2M		
GE Pro1000/ Dinamap	U502-2A	Blood Pressure Interconnect Dual Tube,L=2M		
	U502-2B	Blood Pressure Interconnect Dual Tube,L=2M		
	U502-2C	Blood Pressure Interconnect Dual Tube,L=2M		
	U502-2D	Blood Pressure Interconnect Dual Tube,L=2M		
	U502-2E	Blood Pressure Interconnect Dual Tube,L=2M		
	U502-2F	Blood Pressure Interconnect Dual Tube,L=2M		
	U502-2F	Blood Pressure Interconnect Dual Tube,L=2M		
GE-Datex/ Dixtal	U506-1A	Blood Pressure Interconnect Dual Tube,L=2M		
	U506-1B	Blood Pressure Interconnect Dual Tube,L=2M		
	U506-1C	Blood Pressure Interconnect Dual Tube,L=2M		

Compatible Brand	P/N	Description	Plug to monitor	Plug to cuff
GE-Datex/ Dixtal	U506-1D	Blood Pressure Interconnect Dual Tube,L=2M		
	U506-1E	Blood Pressure Interconnect Dual Tube,L=2M		
Kontron/ GE/ Critikon/ Invivo	U529-1A	Blood Pressure Interconnect Dual Tube,L=2M		
	U529-1B	Blood Pressure Interconnect Dual Tube,L=2M		
	U529-1C	Blood Pressure Interconnect Dual Tube,L=2M		
	U529-1D	Blood Pressure Interconnect Dual Tube,L=2M		
	U529-1E	Blood Pressure Interconnect Dual Tube,L=2M		
Nihon Kohden	U505-1A	Blood Pressure Interconnect Dual Tube,L=2M		
	U505-1B	Blood Pressure Interconnect Dual Tube,L=2M		
	U505-1C	Blood Pressure Interconnect Dual Tube,L=2M		
	U505-1D	Blood Pressure Interconnect Dual Tube,L=2M		
	U505-1E	Blood Pressure Interconnect Dual Tube,L=2M		
	U505-1F	Blood Pressure Interconnect Dual Tube,L=2M		
	U505-1F	Blood Pressure Interconnect Dual Tube,L=2M		
Nihon Kohden OPV1500K	U505-2A	Blood Pressure Interconnect Dual Tube,L=2M		

Compatible Brand	P/N	Description	Plug to monitor	Plug to cuff
Nihon Kohden OPV1500K	U505-2B	Blood Pressure Interconnect Dual Tube,L=2M		
	U505-2C	Blood Pressure Interconnect Dual Tube,L=2M		
	U505-2D	Blood Pressure Interconnect Dual Tube,L=2M		
	U505-2E	Blood Pressure Interconnect Dual Tube,L=2M		

Compatible Brand	P/N	Description	Plug to monitor	Plug to cuff
	PM0002A	Blood Pressure Interconnect Single Tube,without connector,2M,gray		
	PM0002B	Blood Pressure Interconnect Single Tube,without connector,2M,black		
	PM0003A	Blood Pressure Interconnect Dual Tube,without connector,2M		
	PM0009A	Coiled NIBP Tubing		

Compatible Model	P/N	Image
Creative/Omni NIBP Hose connector	PN0001A	
GE Marquette NIBP Hose connector	PN0002A	
GE Dinamap/ Pro1000 NIBP Hose connector	PN0003A	
GE-Datex/Dixtal NIBP Hose connector	PN0004A	
GE/Nihon Kohden Adapter NIBP Cuff connector	PN0005A	
M&B/Pace Tech NIBP Hose connector	PN0019A	

Compatible Model	P/N	Image
Nihon Kohden NIBP Hose connector	PN0020A	
NIBP Cuff connector for big size	PN0008A	
GE/Datex NIBP Hose connector	PN0006A	
Philips/Mindray/ Spacelabs /MEK NIBP Hose connector	PN0007A	
NIBP connector	PN0035A	
Philips NIBP connector	PN0036A	

G~N

C~P

Compatible Model	P/N	Image	Compatible Model	P/N	Image
Drager NIBP connector	PN0037A		Disposable NIBP Cuff connector	PN0028A	
GE Hose connector	PN0044A		Disposable NIBP Cuff connector	PN0029A	
Colin NIBP Hose connector	PN0016A		Disposable NIBP Cuff connector	PN0030A	
Criticare/Colin/Datascope/Spacelabs/Welch Allyn/NIBP Hose connector	PN0015A		Omron NIBP cuff connector	PN0031A	
GE Nihon kohden Adapter NIBP Cuff connector	PN0021A		Double Hose connector	PN0033A	
Critikon/Invivo/Kontron/MEK/Nihon Kohden NIBP connector	PN0017A		BP Black Ball	PN0032A	
Colin/Datascope/Spacelabs NIBP Hose connector	PN0023A		Creative/Omni NIBP Socket	PN0001B	
Welch Allyn/GE Critikon/Invivo/Kontron/Mennen/Nihon Kohden NIBP Cuff connector	PN0024A		Medtronic-Physio Control NIBP Hose connector	PN0011A	
Disposable NIBP Cuff connector	PN0027A		Siemens NIBP Hose connector	PN0012A	

Compatible Model	P/N	Image	Compatible Model	P/N	Image
Philips NIBP Hose connector	PN0013A		Drager NIBP connector	PN0037B	
Mindray/Philips NIBP Socket	PN0007B		GE Hose connector	PN0044B	
M&B NIBP Socket	PN0019B		Metal Cuff connector	PN0018B	
Nihon Kohden Hose connector	PN0038A		Criticare/Colin/Datascope/Spacelabs/Welch Allyn/Nihon Kohden Adapter NIBP Cuff connector	PN0015B	
Normal Plastic Cuff connector	PN0026A		GE/Nihon Kohden Y type adapter BP Hose connector	PN0021B	
GE/Datex NIBP Cuff connector	PN0006B		Welch Allyn Hose connector	PN0039A	
Normal NIBP Cuff connector	PN0009A		OD7.8*24 Hose connector	PN0023B	
NIBP connector	PN0035B		Critikon/GE Medical/Goldway/Kontron/Invivo NIBP Hose connector	PN0024B	
Philips NIBP connector	PN0036B		Omron BP Machine connector	PN0040A	

D~S

P~O

Compatible Model	P/N	Image	Compatible Model	P/N	Image
Nihon Kohden Hose connector	PN0034B		Medtronic Physio-Control connector	PN0046A	
Screw Cuff connector	PN0045A		Double Hose connector	PN0033B	
NIBP connector	PN0035C		White cuff connector	PN0047A	

N~W

HOT PRODUCT DISPLAY



IBP Cable

U802-1A

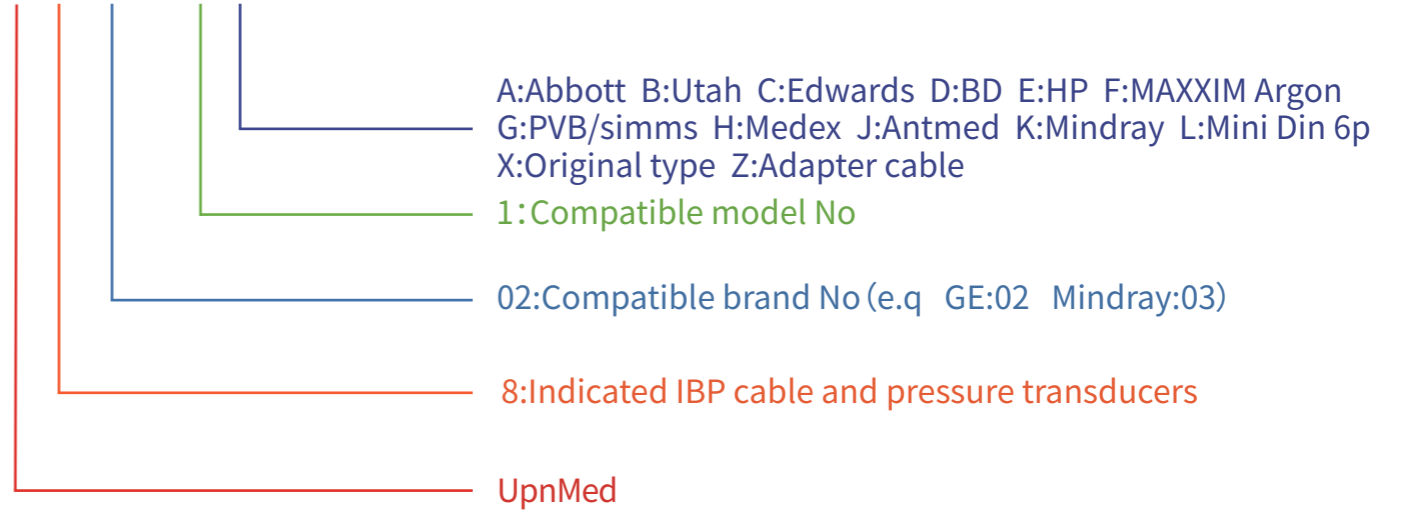

Hot product display





























Brand	Compatible Model	P/N	Description	Image	Image
Bionet (6pin)		U823-1A	Bionet-Abbott IBP Cable,2.8M,6pin-6P6C Jack		
		U823-1B	Bionet-Utah IBP Cable,2.8M,6pin-4Plug		
		U823-1C	Bionet-Edwards IBP Cable,2.8M,6pin-5Plug		
		U823-1D	Bionet-BD IBP Cable,2.8M,6pin-7Plug		
		U823-1E	Bionet-HP/Bruan IBP Cable,2.8M,6pin-4Plug		
		U823-1F	Bionet-Argon/MAXXIM IBP Cable,2.8M,6pin-5pin		
		U823-1G	Bionet-PVB/SIMMS IBP Cable,2.8M,6pin-5pin		
		U823-1H	Bionet-Medex950 IBP Cable,2.8M,6pin-6P6C Jack		
Biolight (4pin)		U809-1A	Biolight-Abbott IBP Cable,2.8M,4pin-6P6C Jack		
		U809-1B	Biolight-Utah IBP Cable,2.8M,4pin-4Plug		
		U809-1C	Biolight-Edwards IBP Cable,2.8M,4pin-5Plug		
		U809-1D	Biolight-BD IBP Cable,2.8M,4pin-7Plug		
		U809-1E	Biolight-HP/Bruan IBP Cable,2.8M,4pin-4Plug		
		U809-1F	Biolight-Argon/MAXXIM IBP Cable, 2.8M, 4pin-5pin		
		U809-1G	Biolight-PVB/SIMMS IBP Cable,2.8M,4pin-5pin		
		U809-1H	Biolight-Medex950 IBP Cable,2.8M,4pin-6P6C Jack		
Biolight (6pin)		U809-2A	Biolight-Abbott IBP Cable,2.8M,6pin-6P6C Jack		
		U809-2B	Biolight-Utah IBP Cable,2.8M,6pin-4Plug		
		U809-2C	Biolight-Edwards IBP Cable,2.8M,6pin-5Plug		
		U809-2D	Biolight-BD IBP Cable,2.8M,6pin-7Plug		
		U809-2E	Biolight-HP/Bruan IBP Cable,2.8M,6pin-4Plug		
		U809-2F	Biolight-Argon/MAXXIM IBP Cable, 2.8M, 6pin-5pin		
		U809-2G	Biolight-PVB/SIMMS IBP Cable,2.8M,6pin-5pin		
		U809-2H	Biolight-Medex950 IBP Cable,2.8M,6pin-6P6C Jack		



























Brand	Compatible Model	P/N	Description	Image	Image
CSI (5pin)		U812-1A	CSI-Abbott IBP Cable,2.8M,5pin-6P6C Jack		
		U812-1B	CSI-Utah IBP Cable,2.8M,5pin-4Plug		
		U812-1C	CSI-Edwards IBP Cable,2.8M,5pin-5Plug		
		U812-1D	CSI-BD IBP Cable,2.8M,5pin-7Plug		
		U812-1E	CSI-HP/Bruan IBP Cable,2.8M,5pin-4Plug		
		U812-1F	CSI-Argon/MAXXIM IBP Cable,2.8M,5pin-5pin		
		U812-1G	CSI-PVB/SIMMS IBP Cable,2.8M,5pin-5pin		
		U812-1H	CSI-Medex950 IBP Cable,2.8M,5pin-6P6C Jack		
Comen (12pin)		U838-1A	Comen-Abbott IBP Cable,2.8M,12pin-6P6C Jack		
		U838-1B	Comen-Utah IBP Cable,2.8M,12pin-4Plug		
		U838-1C	Comen-Edwards IBP Cable,2.8M,12pin-5Plug		
		U838-1D	Comen-BD IBP Cable,2.8M,12pin-7Plug		
		U838-1E	Comen-HP/Bruan IBP Cable,2.8M,12pin-4Plug		
		U838-1F	Comen-Argon/MAXXIM IBP Cable, 2.8M, 12pin-5pin		
		U838-1G	Comen-PVB/SIMMS IBP Cable,2.8M,12pin-5pin		
		U838-1H	Comen-Medex950 IBP Cable,2.8M,12pin-6P6C Jack		
Datex (10pin)		U806-1A	Datex-Abbott IBP Cable,2.8M,10pin-6P6C Jack		
		U806-1B	Datex-Utah IBP Cable,2.8M,10pin-4Plug		
		U806-1C	Datex-Edwards IBP Cable,2.8M,10pin-5Plug		
		U806-1D	Datex-BD IBP Cable,2.8M,10pin-7Plug		
		U806-1E	Datex-HP/Bruan IBP Cable,2.8M,10pin-4Plug		
		U806-1F	Datex-Argon/MAXXIM IBP Cable, 2.8M, 10pin-5pin		
		U806-1G	Datex-PVB/SIMMS IBP Cable,2.8M,10pin-5pin		
		U806-1H	Datex-Medex950 IBP Cable,2.8M,10pin-6P6C Jack		
		U806-1K	Datex-Mindray IBP cable, 2.8M, 10pin-4pins		

B~B

C~D

Brand	Compatible Model	P/N	Description	Image	Image
Datscope (6 pin)		U814-1A	Datscope-Abbott IBP Cable,2.8M,6pin-6P6C Jack		
		U814-1B	Datscope-Utah IBP Cable,2.8M,6pin-4Plug		
		U814-1C	Datscope-Edwards IBP Cable,2.8M,6pin-5Plug		
		U814-1D	Datscope-BD IBP Cable,2.8M,6pin-7Plug		
		U814-1E	Datscope-HP/Bruan IBP Cable,2.8M,6pin-4Plug		
		U814-1F	Datscope-Argon/MAXXIM IBP Cable, 2.8M, 6pin-5pin		
		U814-1G	Datscope-PVB/SIMMS IBP Cable, 2.8M, 6pin-5pin		
		U814-1H	Datscope-Medex950 IBP Cable,2.8M,6pin-6P6C Jack		
		U814-1L	Datscope-Mini Din 6P IBP cable,2.8M, 6pin-Mini Din 6P		
Datscope (5pin)		U814-2A	Datscope-Abbott IBP Cable,2.8M,5pin-6P6C Jack		
		U814-2B	Datscope-Utah IBP Cable,2.8M,5pin-4Plug		
		U814-2C	Datscope-Edwards IBP Cable,2.8M,5pin-5Plug		
		U814-2D	Datscope-BD IBP Cable,2.8M,5pin-7Plug		
		U814-2E	Datscope-HP/Bruan IBP Cable,2.8M,5pin-4Plug		
		U814-2F	Datscope-Argon/MAXXIM IBP Cable, 2.8M, 5pin-5pin		
		U814-2G	Datscope-PVB/SIMMS IBP Cable, 2.8M, 5pin-5pin		
		U814-2H	Datscope-Medex950 IBP Cable,2.8M,5pin-6P6C Jack		
		Fukuda Denshi (12 pin)	Mindray Datscope Expert and Fukuda Denshi Dynascope DS-5100, DS-5100E, DS-5300W, DS-5400, DS-7001		U869-1A
U869-1B	Fukuda-Utah IBP Cable,2.8M,12pin-4Plug				
U869-1C	Fukuda-Edwards IBP Cable,2.8M,12pin-5Plug				
U869-1D	Fukuda-BD IBP Cable,2.8M,12pin-7Pug				
U869-1E	Fukuda-HP/Bruan IBP Cable,2.8M,12pin-4Plug				
U869-1F	Fukuda-Argon/MAXXIM IBP Cable,2.8M, 12pin-5pin				
U869-1G	Fukuda-PVB/SIMMS IBP Cable, 2.8M, 12pin-5pin				
U869-1H	Fukuda-Medex950 IBP Cable,2.8M,12pin-6P6C Jack				

D~F

Brand	Compatible Model	P/N	Description	Image	Image
GE-Marqutte (11pin)	GE Solar,Dash, Eagle,Tram	U802-1A	GE-Abbott IBP Cable,2.8M,11pin-6P6C Jack		
		U802-1B	GE-Utah IBP Cable,2.8M,11pin-4Plug		
		U802-1C	GE-Edwards IBP Cable,2.8M,11pin-5Plug		
		U802-2D	GE-BD IBP Cable,2.8M,11pin-7Plug		
		U802-1E	GE-HP/Bruan IBP Cable,2.8M,11pin-4Plug		
		U802-1F	GE-Argon/MAXXIM IBP Cable,2.8M,11pin-5pin		
		U802-1G	GE-PVB/SIMMS IBP Cable,2.8M,11pin-5pin		
		U802-1H	GE-Medex950 IBP Cable,2.8M,11pin-6P6C Jack		
		U802-1K	GE-Mindray IBP cable, 2.8M, 11pin-4pin		
		U802-3L	GE-Mini Din 6P IBP cable, 2.8M		
Lohmeier (12pin)	M010	U818-1A	Lohmeier-Abbott IBP Cable,2.8M,12pin-6P6C Jack		
		U818-1B	Lohmeier-Utah IBP Cable,2.8M,12pin-4Plug		
		U818-1C	Lohmeier-Edwards IBP Cable,2.8M,12pin-5Plug		
		U818-1D	Lohmeier-BD IBP Cable,2.8M,12pin-7Plug		
		U818-1E	Lohmeier-HP/Bruan IBP Cable,2.8M,12pin-4Plug		
		U818-1F	Lohmeier-Argon/MAXXIM IBP Cable,2.8M, 12pin-5pin		
		U818-1G	Lohmeier-PVB/SIMMS IBP Cable,2.8M,12pin-5pin		
		U818-1H	Lohmeier-Medex950 IBP Cable,2.8M,12pin-6P6C Jack		
		Mindray (6pin)	PM7000,8000, 9000,6201,PM-2000		U803-1A
U803-1B	Mindray-Utah IBP Cable,2.8M,6pin-4Plug				
U803-1C	Mindray-Edwards IBP Cable,2.8M,6pin-5Plug				
U803-1D	Mindray-BD IBP Cable,2.8M,6pin-7Plug				
U803-1E	Mindray-HP/Bruan IBP Cable,2.8M,6pin-4Plug				
U803-1F	Mindray-Argon/MAXXIM IBP Cable,2.8M,6pin-5pin				
U803-1G	Mindray-PVB/SIMMS IBP Cable,2.8M,6pin-5pin				
U803-1H	Mindray-Medex950 IBP Cable,2.8M,6pin-6P6C Jack				

G~M

Brand	Compatible Model	P/N	Description	Image	Image
Mindray (12pin)	PM6000,PM6800, Beneview T5,T8,T1, IMEC12, IMEC10, IMEC8,IPM8,IPM10, IPM12,IPM9800, Beneheart D6	U803-2A	Mindray-Abbott IBP Cable,2.8M,12pin-6P6C Jack		
		U803-2B	Mindray-Utah IBP Cable,2.8M,12pin-4Plug		
		U803-2C	Mindray-Edwards IBP Cable,2.8M,12pin-5Plug		
		U803-2D	Mindray-BD IBP Cable,2.8M,12pin-7Plug		
		U803-2E	Mindray-HP/Bruan IBP Cable,2.8M,12pin-4Plug		
		U803-2F	Mindray-Argon/MAXXIM IBP cable, 2.8M, 12pin-5pin		
		U803-2G	Mindray-PVB/SIMMS IBP Cable,2.8M,12pin-5pin		
		U803-2H	Mindray-Medex950 IBP Cable,2.8M,12pin-6P6C Jack		
		U803-2K	Mindray-Mindray IBP cable, 2.8M,12pin-4Plug		
		MEK (6pin)	All MEK		U813-1A
U813-1B	MEK-Utah IBP Cable,2.8M,6pin-4Plug				
U813-1C	MEK-Edwards IBP Cable,2.8M,6pin-5Plug				
U813-1D	MEK-BD IBP Cable,2.8M,6pin-7Plug				
U813-1E	MEK-HP/Bruan IBP Cable,2.8M,6pin-4Plug				
U813-1F	MEK-Argon/MAXXIM IBP Cable,2.8M,6pin-5pin				
U813-1G	MEK-PVB/SIMMS IBP Cable,2.8M,6pin-5pin				
Nihon Kohden (14pin)	All Nihon Kohden			U805-1A	Nihon Kohden-Abbott IBP Cable,2.8M,14pin-6P6C Jack
		U805-1B	Nihon Kohden-Utah IBP Cable,2.8M,14pin-4Plug		
		U805-1C	Nihon Kohden-Edwards IBP Cable,2.8M,14pin-5Plug		
		U805-1D	Nihon Kohden-BD IBP Cable,2.8M,14pin-7Plug		
		U805-1E	Nihon Kohden-HP/Bruan IBP Cable,2.8M, 14pin-4Plug		
		U805-1F	Nihon Kohden-Argon/MAXXIM IBP Cable, 2.8M, 14pin-5pin		
		U805-1G	Nihon Kohden-PVB/SIMMS IBP Cable,2.8M, 14pin-5pin		
		U805-1H	Nihon Kohden-Medex950 IBP Cable,2.8M, 14pin-6P6C Jack		

Brand	Compatible Model	P/N	Description	Image	Image			
Nihon Kohden (6pin 60°)	SVM	U805-2A	Nihon Kohden-Abbott IBP Cable,2.8M,6pin-6P6C Jack					
		U805-2B	Nihon Kohden-Utah IBP Cable,2.8M,6pin-4Plug					
		U805-2C	Nihon Kohden-Edwards IBP Cable,2.8M,6pin-5Plug					
		U805-2D	Nihon Kohden-BD IBP Cable,2.8M,6pin-7Plug					
		U805-2E	Nihon Kohden -HP/Bruan IBP Cable,2.8M, 6pin-4Plug					
		U805-2F	Nihon Kohden-Argon/MAXXIM IBP Cable, 2.8M 6pin-5pin					
		U805-2G	Nihon Kohden-PVB/SIMMS IBP Cable,2.8M, 6pin-5pin					
		U805-2H	Nihon Kohden-Medex950 IBP Cable,2.8M, 6pin-6P6C Jack					
		Nihon Kohden (5pin)			U805-3L	Nihon Kohden-Mini Dini 6P IBP cable, 2.8M, 5pin-Mini Din type		
		Philips (12pin)	M1567A,M1568A Kit		U804-1A	Philips-Abbott/Medex IBP Cable,2.8M,12pin-6P6C Jack		
U804-1B	Philips-Utah IBP Cable,2.8M,12pin-4Plug							
U804-1C	Philips-Edwards IBP Cable,2.8M,12pin-5Plug							
U804-1D	Philips-BD IBP Cable,2.8M,12pin-7plug							
U804-1E	Philips-HP/Bruan IBP Cable,2.8M,12pin-4Plug							
U804-1F	Philips-Argon/MAXXIM IBP Cable,2.8M,12pin-5pin							
U804-1G	Philips-PVB/SIMMS IBP Cable,2.8M,12pin-5pin							
U804-1H	Philips-Medex950 IBP Cable,2.8M,12pin-6P6C Jack							
U804-1K	Philips-Mindray IBP cable, 2.8M,12pin-4pin							
U804-1L	Philips-Mini Din 6P IBP cable, 2.8M,12pin-Mini Din 6P							
Siemens (10pin)	Sirecust 700, Sirecust 630.	U815-1A	Siemens-Abbott IBP Cable,2.8M,10pin-6P6C Jack					
		U815-1B	Siemens-Utah IBP Cable,2.8M,10pin-4Plug					
		U815-1C	Siemens-Edwards IBP Cable,2.8M,10pin-5Plug					
		U815-1D	Siemens-BD IBP Cable,2.8M,10pin-7Plug					

M~N

N~S

Brand	Compatible Model	P/N	Description	Image	Image
Siemens (10pin)	Sirecust 700, Sirecust 630.	U815-1E	Siemens-HP/Bruan IBP Cable,2.8M,10pin-4Plug		
		U815-1F	Siemens-Argon/MAXXIM IBP Cable,2.8M, 10pin-5pin		
		U815-1G	Siemens-PVB/SIMMS IBP Cable,2.8M,10pin-5pin		
		U815-1H	Siemens-Medex950 IBP Cable,2.8M,10pin-6P6C Jack		
		U815-1K	Siemens-Mindray IBP cable, 2.8M, 10pin-4pin		
Siemens Drager (7pin)	All Siemens Drager(which require 7pin connector cable)	U815-2A	Drager-Abbott IBP Cable,2.8M,7pin-6P6C Jack		
		U815-2B	Drager-Utah IBP Cable,2.8M,7pin-4Plug		
		U815-2C	Drager-Edwards IBP Cable,2.8M,7pin-5Plug		
		U815-2D	Drager-BD IBP Cable,2.8M,7pin-7Plug		
		U815-2E	Drager-HP/Bruan IBP Cable,2.8M,7pin-4Plug		
		U815-2F	Drager-Argon/MAXXIM IBP Cable,2.8M,7pin-5pin		
		U815-2G	Drager-PVB/SIMMS IBP Cable,2.8M,7pin-5pin		
		U815-2H	Drager-Medex950 IBP Cable,2.8M,7pin-6P6C Jack		
		U815-2K	Drager-Mindray IBP cable, 2.8M,7pin-4pin		
		Spacelabs (10pin)			U807-1A
U807-1B	Spacelabs-Utah IBP Cable,2.8M,10pin-4Plug				
U807-1C	Spacelabs-Edwards IBP Cable,2.8M,10pin-5Plug				
U807-1D	Spacelabs-BD IBP Cable,2.8M,10pin-7Plug				
U807-1E	Spacelabs-HP/Bruan IBP Cable,2.8M,10pin-4Plug				
U807-1F	Spacelabs-Argon/MAXXIM IBP Cable,2.8M, 10pin-5pin				
U807-1G	Spacelabs-PVB/SIMMS IBP Cable,2.8M, 10pin-5pin				
U807-1H	Spacelabs-Medex950 IBP Cable,2.8M, 10pin-6P6C Jack				
Spacelabs (6pin)		U807-2A	Spacelabs-Abbott IBP Cable,2.8M,6pin-6P6C Jack		
		U807-2B	Spacelabs-Utah IBP Cable,2.8M,6pin-4Plug		

Brand	Compatible Model	P/N	Description	Image	Image			
Spacelabs (6pin)		U807-2C	Spacelabs-Edwards IBP Cable,2.8M,6pin-5Plug					
		U807-2D	Spacelabs-BD IBP Cable,2.8M,6pin-7Plug					
		U807-2E	Spacelabs-HP/Bruan IBP Cable,2.8M,6pin-4Plug					
		U807-2F	Spacelabs-Argon/MAXXIM IBP Cable,2.8M, 6pin-5pin					
		U807-2G	Spacelabs-PVB/SIMMS IBP Cable,2.8M,6pin-5pin					
		U807-2H	Spacelabs-Medex950 IBP Cable,2.8M,6pin-6P6C Jack					
		U807-2L	Spacelabs-Mini Din 6P IBP cable, 2.8M,6pin- Mini Din 6P					
Schiller (12pin)		U825-1A	Schiller-Abbott IBP Cable,2.8M,12pin-6P6C Jack					
		U825-1B	Schiller-Utah IBP Cable,2.8M,12pin-4Plug					
		U825-1C	Schiller-Edwards IBP Cable,2.8M,12pin-5Plug					
		U825-1D	Schiller-BD IBP Cable,2.8M,12pin-7Plug					
		U825-1E	Schiller-HP/Bruan IBP Cable,2.8M,12pin-4Plug					
		U825-1F	Schiller-Argon/MAXXIM IBP Cable,2.8M,12pin-5pin					
		U825-1G	Schiller-PVB/SIMMS IBP Cable,2.8M,12pin-5pin					
		U825-1H	Schiller-Medex950 IBP Cable,2.8M,12pin-6P6C Jack					
		Welch Allyn (6pin)			U861-1E	Welch Allyn-HP Bruan IBP cable, 2.8M 6pin-4Plug		
		IBP adapter cable						
GE (11pin)		U802-1Z	GE IBP adapter cable,Durable cable for extension cable , 11pin-double 11pin					
Siemens (16pin)		U815-4Z	Siemens IBP adapter cable,16pin-double round 7Pin					
		U815-3Z	Siemens IBP adapter cable,16pin-double round 10Pin					
Spacelabs (10pin)		U807-1Z	Spacelabs IBP adapter cable, 10pin-double round 6pin					

S~S

S~S

Brand	Compatible Model	P/N	Description	Image
Disposable Transducer				
Disposable Transducer	Single line	U800-1A	Abbott Disposable Transducer	
		U800-1B	Utah Disposable Transducer	
		U800-1C	Edwards Disposable Transducer	
		U800-1D	BD Disposable Transducer	
		U800-1E	Philips/B.Bruan Disposable Transducer	
		U800-1F	Argon/MAXXIM Disposable Transducer	
		U800-1G	PVB/SIMMS Disposable Transducer	
		U800-1H	Medex Disposable Transducer	
		U800-1J	Antmed Disposable Transducer	
		U800-1K	Mindray Disposable Transducer	
Disposable Transducer	Double line	U800-2A	Abbott/Medex Disposable Transducer	
		U800-2B	Utah Disposable Transducer	
		U800-2C	Edwards Disposable Transducer	
		U800-2D	BD Disposable Transducer	
		U800-2E	Philips/B.Bruan Disposable Transducer	
		U800-2F	Argon/MAXXIM Disposable Transducer	
		U800-2G	PVB/SIMMS Disposable Transducer	
		U800-2H	Medex Disposable Transducer	
		U800-2J	Antmed Disposable Transducer	
		U800-2K	Mindray Disposable Transducer	

D~D





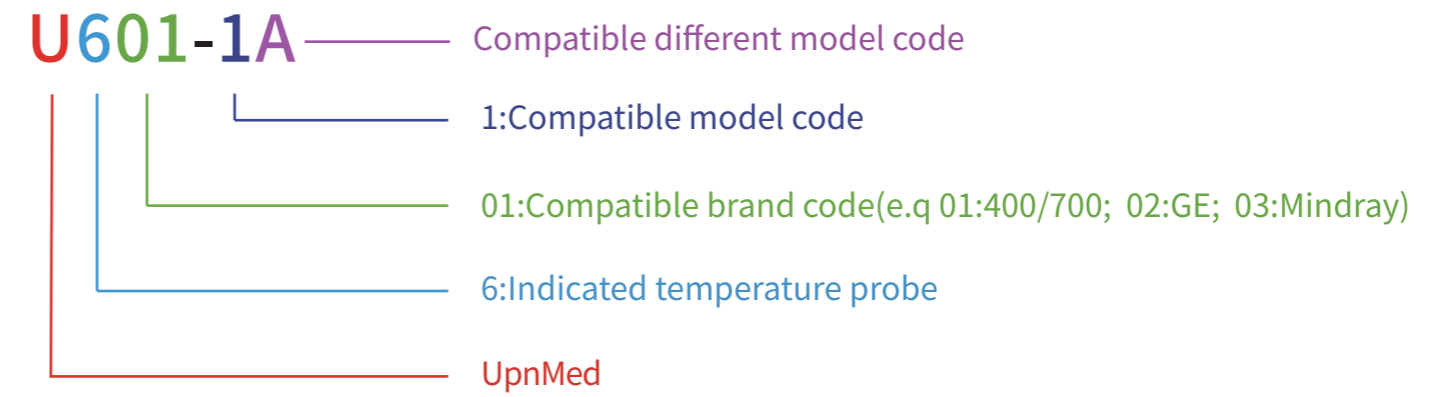













Temperature probe



Hot product display













Compatible Brand	P/N	Description	Male Connector	Skin/Oral Side
YSI 400 series	U601-1A	Adult Rectal/Esophageal temperature probe, 2.25KΩ,3meter		
	U601-1C	Pediatric Rectal/Esophageal Temperature probe,2.25KΩ,3meter		
	U601-1M	Infant Rectal/Esophageal Temperature probe, 2.25KΩ,3meter		
	U601-1B	Adult Skin surface Temperature probe, 2.25KΩ,3meter		
	U601-1D	Pediatric Skin Temperature probe,2.25KΩ,3meter		
	U601-1N	Infant Skin Temperature probe,2.25KΩ,3meter		
	U601-2A	Adult Rectal/Esophageal Temperature probe, 10KΩ,3meter		
	U601-2C	Pediatric Rectal/Esophageal Temperature probe, 10KΩ,3meter		
	U601-2M	Infant Rectal/Esophageal Temperature probe, 10KΩ,3meter		
	U601-2B	Adult Skin surface Temperature probe, 10KΩ,3meter		
	U601-2D	Pediatric Skin Temperature probe, 10KΩ, 3meter		
	U601-2N	Infant Skin Temperature probe, 10KΩ,3meter		
	U601-1F	YSI 400 series Temperature interface cable, Rectangle 2Pin,3meter		

















Compatible Brand	P/N	Description	Male Connector	Skin/Oral Side	
YSI 400 series	U601-D1FA	Rectal/Esophageal Disposable Temperature probe,2.25KΩ,0.8meter MOQ: 100pcs			
	U601-D1FB	Adult Skin surface Disposable Temperature probe,2.25KΩ,0.8meter MOQ: 100pcs			
	U601-D1GA	Adult Rectal/Esophageal Disposable Temperature probe,2.25KΩ,0.8meter MOQ: 100pcs			
	U601-D1GB	Adult Skin surface Disposable Temperature probe,2.25KΩ,0.8meter MOQ: 100pcs			
	U601-D2GA	Adult Rectal/Esophageal Disposable Temperature probe,10KΩ,0.8meter MOQ: 100pcs			
	U601-D2GB	Adult Skin surface Disposable Temperature probe,10KΩ,0.8meter MOQ: 100pcs			
YSI 700 series	U601-3A	Adult Rectal/Esophageal Temperature probe, 6KΩ/30KΩ,3meter			
	U601-3B	Adult Skin surface Temperature probe, 6KΩ/30KΩ,3meter			
18B20	U6104-1A	Adult Rectal/Esophageal Temperature probe,18B20,3meter			
	U6104-1B	Adult Skin surface Temperature probe,18B20, 3meter			
Air Shield	U6105-1A	Adult Rectal/Esophageal Temperature probe, 6.86KΩ,3pin,3meter			
	U6105-1C	Pediatric Rectal/Esophageal Temperature probe,6.86KΩ,3pin,3meter			
	U6105-1M	Infant Rectal/Esophageal Temperature probe, 6.86KΩ,3pin,3meter			

Y~Y

















Y~A





















Compatible Brand	P/N	Description	Male Connector	Skin/Oral Side
Air Shield	U6105-1B	Adult Skin surface Temperature probe, 6.86KΩ,3pin,3meter		
	U6105-1D	Pediatric Skin Temperature probe, 6.86KΩ,3pin,3meter		
	U6105-1N	Infant Skin Temperature probe,6.86KΩ,3pin,3meter		
Atom	U6106-1A	Adult Rectal/Esophageal Temperature probe, 2.25KΩ,6pin,3meter		
	U6106-1C	Pediatric Rectal/Esophageal Temperature probe,2.25KΩ,6pin,3meter		
	U6106-1M	Infant Rectal/Esophageal Temperature probe,2.25KΩ,6pin,3meter		
	U6106-1B	Adult Skin surface Temperature probe,2.25KΩ,6pin,3meter		
	U6106-1D	Pediatric Skin Temperature probe,2.25KΩ,6pin,3meter		
	U6106-1N	Infant Skin Temperature probe,2.25KΩ,6pin,3meter		
Artema	U632-1A	Adult Rectal/Esophageal Temperature probe, 2.25KΩ,10pin,3meter		
	U632-1C	Pediatric Rectal/Esophageal Temperature probe,2.25KΩ,10pin,3meter		
	U632-1M	Infant Rectal/Esophageal Temperature probe,2.25KΩ,10pin,3meter		
	U632-1B	Adult Skin surface Temperature probe,2.25KΩ,10pin,3meter		

A~A

Compatible Brand	P/N	Description	Male Connector	Skin/Oral Side
Artema	U632-1D	Pediatric Skin Temperature probe,2.25KΩ,10pin,3meter		
	U632-1N	Infant Skin Temperature probe,2.25KΩ,10pin,3meter		
Biolight	U609-1A	Adult Rectal/Esophageal Temperature probe, 2.25KΩ,2pin,3meter		
	U609-1C	Pediatric Rectal/Esophageal Temperature probe,2.25KΩ,2pin,3meter		
	U609-1M	Infant Rectal/Esophageal Temperature probe,2.25KΩ,2pin,3meter		
	U609-1B	Adult Skin surface Temperature probe,2.25KΩ,2pin,3meter		
	U609-1D	Pediatric Skin Temperature probe,2.25KΩ,2pin,3meter		
	U609-1N	Infant Skin Temperature probe,2.25KΩ,2pin,3meter		
	U609-1F	Biolight Temperature interface cable, Rectangle 2Pin,3meter		
Comen	U638-1A	Adult Rectal/Esophageal Temperature probe,10KΩ,2pin,3meter		
	U638-1C	Pediatric Rectal/Esophageal Temperature probe,10KΩ,2pin,3meter		
	U638-1M	Infant Rectal/Esophageal Temperature probe, 10KΩ,2pin,3meter		
	U638-1B	Adult Skin surface Temperature probe,10KΩ,2pin,3meter		

A~C

Compatible Brand	P/N	Description	Male Connector	Skin/Oral Side
Comen	U638-1D	Pediatric Skin Temperature probe,10KΩ,2pin,3meter		
	U638-1N	Infant Skin Temperature probe,10KΩ,2pin,3meter		
Creative	U610-1A	Adult Rectal/Esophageal Temperature probe,10KΩ,2pin,3meter		
	U610-1C	Pediatric Rectal/Esophageal Temperature probe,10KΩ,2pin,3meter		
	U610-1M	Infant Rectal/Esophageal Temperature probe,10KΩ,2pin,3meter		
	U610-1B	Adult Skin surface Temperature probe,10KΩ,2pin,3meter		
	U610-1D	Pediatric Skin Temperature probe,10KΩ,2pin,3meter		
	U610-1N	Infant Skin Temperature probe,10KΩ,2pin,3meter		
Datascope	U614-1A	Datascope Adult Rectal/Esophageal Temperature probe,2.25KΩ,5pin,3meter		
	U614-1C	Rectal/Esophageal Temperature probe,2.25KΩ,5pin,3meter		
	U614-1M	Infant Rectal/Esophageal Temperature probe,2.25KΩ,5pin,3meter		
	U614-1B	Adult Skin surface Temperature probe,2.25KΩ,5pin,3meter		
	U614-1D	Pediatric Skin Temperature probe,2.25KΩ,5pin,3meter		

Compatible Brand	P/N	Description	Male Connector	Skin/Oral Side	
Datascope	U614-1N	Infant Skin Temperature probe,2.25KΩ,5pin,3meter			
Drager/Air Shields C2000	U615-2N	Drager Infant Skin Temperature Probe,Mini5Pin,9.1KΩ,3meter			
GE	U602-1A	Adult Rectal/Esophageal Temperature probe,2.25KΩ,11pin,3meter			
	U602-1C	Pediatric Rectal/Esophageal Temperature probe,2.25KΩ,11pin,3meter			
	U602-1M	Infant Rectal/Esophageal Temperature probe,2.25KΩ,11pin,3meter			
	U602-1B	Adult Skin surface Temperature probe,2.25KΩ,11pin,3meter			
	U602-1D	Pediatric Skin Temperature probe,2.25KΩ,11pin,3meter			
	U602-1N	Infant Skin Temperature probe,2.25KΩ,11pin,3meter			
	U602-2C	GE V100 Oral Temperature Probe,Crystal head Connector			
	U602-1F	GE Temperature interface cable,Rectangle 2Pin,3meter			
	U602-1G	GE Temperature Interface Cable,3.5mm Female			
	U602-1J	GE Temperature extension cable,to YSI 400 series & YSI 700 series			
U602-3J	GE Temperature interface cable,6.3mm Female,0.5meter				

C~D

















D~G

Compatible Brand	P/N	Description	Male Connector	Skin/Oral Side
GE-Ohmeda Giraffe	U611-1A	Adult Rectal/Esophageal Temperature probe, 10KΩ/10KΩ,3pin,3meter		
	U611-1C	Pediatric Rectal/Esophageal Temperature probe, 10KΩ/10KΩ,3pin,3meter		
	U611-1M	Infant Rectal/Esophageal Temperature probe, 10K/10KΩ,3pin,3meter		
	U611-1B	Adult Skin surface Temperature probe,10KΩ/10KΩ, 3pin,3meter		
	U611-1D	Pediatric Skin Temperature probe,10KΩ/10KΩ, 3pin,3meter		
	U611-1N	Infant Skin Temperature probe,10KΩ/10KΩ, 3pin,3meter		
	U611-2N	Ohmeda 3300/3400 Infant Skin Temperature Probe,30KΩ,3meter		
FANEM	U6117-1A	Adult Rectal/Esophageal Temperature probe, 2.25KΩ,3pin,3meter		
	U6117-1C	Pediatric Rectal/Esophageal Temperature probe,2.25KΩ,3pin,3meter		
	U6117-1M	Infant Rectal/Esophageal Temperature probe, 2.25KΩ,3pin,3meter		
	U6117-1B	Adult Skin surface Temperature probe,2.25KΩ,3pin,3meter		
	U6117-1D	Pediatric Skin Temperature probe,2.25KΩ,3pin,3meter		
	U6117-1N	Infant Skin Temperature probe,2.25KΩ,3pin,3meter		

Compatible Brand	P/N	Description	Male Connector	Skin/Oral Side
Fisher&Paykel	 U6119-1E	Fisher&Paykel 900MR 869 dual temperature probe		
	U6119-2E	Fisher&Paykel MR720 temperature probe		
	ODM-90005A	Fisher&Paykel Adpater Cable,4Pin 80degree-2Pin, 0.5meter		
	ODM-90006A	Fisher&Paykel 900MR806 Adapter Cable,4Pin 80degree-3Pin,0.3meter		
	ODM-90006B	Fisher&Paykel 900MR806 Adapter Cable,4Pin 0degree-3Pin,0.3meter		
	ODM-90006C	Fisher&Paykel 900MR806 Adapter Cable,4Pin 0degree-3Pin,1.2meter		
	ODM-90007B	Fisher&Paykel 900MR805 Adapter Cable,4Pin 80degree-Double 3Pin,0.3meter		
	ODM-90007A	Fisher&Paykel 900MR805 Adapter Cable,4Pin 0degree-Double 3Pin,0.3meter		

G~F

F~F

Compatible Brand	P/N	Description	Male Connector	Skin/Oral Side
Infinium	New U667-1A	Adult Rectal/Esophageal Temperature probe, 2.25KΩ,4pin,3meter		
	U667-1C	Rectal/Esophageal Temperature probe,2.25KΩ,4pin,3meter		
	U667-1M	Infant Rectal/Esophageal Temperature probe, 2.25KΩ,4pin,3meter		
	U667-1B	Adult Skin surface Temperature probe, 2.25KΩ,4pin,3meter		
	U667-1D	Pediatric Skin Temperature probe,2.25KΩ,4pin,3meter		
	U667-1N	Infant Skin Temperature probe,2.25KΩ,4pin,3meter		
	U667-1F	Infinium Temperature interface cable, Rectangle 4pin,3meter		
Mindray T5/T8	U603-1A	Adult Rectal/Esophageal Temperature probe, 2.25KΩ,2pin,3meter		
	U603-1C	Pediatric Rectal/Esophageal Temperature probe,2.25KΩ,2pin,3meter		
	U603-1M	Infant Rectal/Esophageal Temperature probe, 2.25KΩ,2pin,3meter		
	U603-1B	Adult Skin surface Temperature probe,2.25KΩ,2pin,3meter		
	U603-1D	Pediatric Skin Temperature probe,2.25KΩ,2pin,3meter		
U603-1N	Infant Skin Temperature probe,2.25KΩ,2pin,3meter			

Compatible Brand	P/N	Description	Male Connector	Skin/Oral Side
Mindray T5/T8	U603-1J	Mindray Temperature interface cable, 6.3m Female,3meter		
	U603-1F	Mindray Temperature interface cable, Rectangle 2pin,3meter		
Mindray VS800	U603-2A	Mindray VS800 Oral Temperature Probe	New 	
Medix DIR-10	U6126-1A	Adult Rectal/Esophageal Temperature probe,10KΩ,3pin,3meter		
	U6126-1C	Pediatric Rectal/Esophageal Temperature probe, 10KΩ,3pin,3meter		
	U6126-1M	Infant Rectal/Esophageal Temperature probe,10KΩ,3pin,3meter		
	U6126-1B	Adult Skin surface Temperature probe, 10KΩ,3pin,3meter		
	U6126-1D	Pediatric Skin Temperature probe,10KΩ,3pin,3meter		
	U6126-1N	Infant Skin Temperature probe,10KΩ,3pin,3meter		
Ningbo David	U6120-1A	Adult Rectal/Esophageal Temperature probe, 50KΩ/50KΩ,6pin,3meter		
	U6120-1C	Pediatric Rectal/Esophageal Temperature probe, 50KΩ/50KΩ,6pin,3meter		
	U6120-1M	Infant Rectal/Esophageal Temperature probe, 50KΩ/50KΩ,6pin,3meter		

I~M

M~N

Compatible Brand	P/N	Description	Male Connector	Skin/Oral Side
Ningbo David	U6120-1B	Adult Skin surface Temperature probe, 50KΩ/50KΩ,6pin,3meter		
	U6120-1D	Pediatric Skin Temperature probe,50KΩ/50KΩ, 6pin,3meter		
	U6120-1N	Infant Skin Temperature probe,30KΩ, 6pin,3meter		
	U6120-2A	Adult Rectal/Esophageal Temperature probe, 30KΩ,4pin, 3meter		
	U6120-2C	Pediatric Rectal/Esophageal Temperature probe, 30KΩ, 4pin,3meter		
	U6120-2M	Infant Rectal/Esophageal Temperature probe, 30KΩ, 4pin,3meter		
	U6120-2B	Adult Skin surface Temperature probe, 30KΩ, 4pin,3meter		
	U6120-2D	Pediatric Skin surface Temperature probe,30KΩ,4pin,3meter		
	U6120-2N	Infant Skin surface Temperature probe, 30KΩ, 4pin,3meter		
Philips	U604-1A	Adult Rectal/Esophageal Temperature probe, 2.25KΩ,2pin,3meter		
	U604-1C	Rectal/Esophageal Temperature probe,2.25KΩ,2pin,3meter		
	U604-1M	Infant Rectal/Esophageal Temperature probe, 2.25KΩ,2pin,3meter		
	U604-1B	Adult Skin surface Temperature probe, 2.25KΩ,2pin,3meter		

Compatible Brand	P/N	Description	Male Connector	Skin/Oral Side
Philips	U604-1D	Pediatric Skin Temperature probe, 2.25KΩ,2pin,3meter		
	U604-1N	Infant Skin Temperature probe,2.25KΩ,2pin,3meter		
	U604-1F	Philips Temperature interface cable,Rectangle 2pin,3meter		
	U604-1J	Philips Temperature interface cable, Stereo Jack,0.5meter(MOQ is 3-5pcs)		
	U604-2A	Adult Rectal/Esophageal Temperature probe, 2.25KΩ,3.5MM,3meter		
	U604-2B	Adult Skin surface Temperature probe, 2.25KΩ,3.5MM,3meter		
	PT100	U692-1A		
U692-1C		Pediatric Rectal/Esophageal Temperature probe,PT100, 3meter		
U692-1M		Infant Rectal/Esophageal Temperature probe,PT100, 3meter		
U692-1B		Adult Skin surface Temperature probe,PT100, 3meter		
U692-1D		Pediatric Skin Temperature probe,PT100, 3meter		
Siemens	U615-1A	Adult Rectal/Esophageal Temperature probe, 2.25KΩ,7pin,3meter		

N~P

P~S

Compatible Brand	P/N	Description	Male Connector	Skin/Oral Side
Siemens	U615-1C	Pediatric Rectal/Esophageal Temperature probe, 2.25KΩ, 7pin, 3meter		
	U615-1M	Infant Rectal/Esophageal Temperature probe, 2.25KΩ, 7pin, 3meter		
	U615-1B	Adult Skin surface Temperature probe, 2.25KΩ, 7pin, 3meter		
	U615-1D	Pediatric Skin Temperature probe, 2.25KΩ, 7pin, 3meter		
	U615-1N	Infant Skin Temperature probe, 2.25KΩ, 7pin, 3meter		
	U615-1F	Temperature interface cable, 7pin, 3meter		
S~W Spacelabs	U607-1A	Adult Rectal/Esophageal Temperature probe, 2.25KΩ, 10pin, 3meter		
	U607-1C	Pediatric Rectal/Esophageal Temperature probe, 2.25KΩ, 10pin, 3meter		
	U607-1M	Infant Rectal/Esophageal Temperature probe, 2.25KΩ, 10pin, 3meter		
	U607-1B	Adult Skin surface Temperature probe, 2.25KΩ, 10pin, 3meter		
	U607-1D	Pediatric Skin Temperature probe, 2.25KΩ, 10pin, 3meter		
	U607-1N	Infant Skin Temperature probe, 2.25KΩ, 10pin, 3meter		
Welch Allyn	U661-1A	02895-000 Oral Temperature Probe, 8 pin	 New	
	U661-2A	01690-200 Oral Temperature Probe, 6 pin	 New	



Ultrasound Probe



P/N	Description
UT132-1A	Analogic US transducer Probe, 14 pin
UT009-1A	Biolight US transducer Probe, 5 pin
UT009-1B	Biolight TOCO transducer Probe, 4 pin
UT009-2D	Biolight TOCO transducer Probe, 6 pin
UT046-1C	Biocare IC-90 TOCO and US transducer Probe, 3 in 1, 6 pin
UT046-2A	Biocare US transducer Probe, 5 pin
UT046-3B	Biocare TOCO transducer Probe, 4 pin
UT023-1A	Bionet FC-700 US transducer Probe, mini 6 pin
UT023-1B	Bionet FC-700 TOCO transducer Probe, mini 6 pin
UT160-1B	Bistos TOCO transducer Probe, 6 pin
UT160-1A	Bistos US transducer Probe, 6 pin
UT160-1L	Bistos Event marker 3.5mm Din type
UT160-2B	Bionics TOCO transducer Probe, round 6 pin
UT160-2A	Bionics US transducer Probe, round 6 pin
UT090-1A	Carewell US transducer Probe, 5 pin yellow connector
UT090-3D	Carewell TOCO and US transducer Probe, 3 in 1, 6 pin 40degree
UT038-1A	Comen US transducer Probe, 7 pin
UT038-1B	Comen STAR 5000E TOCO transducer Probe, 7 pin
UT038-2A	Comen US transducer Probe, 4 pin 40degree
UT038-2B	Comen TOCO transducer Probe, 4 pin 40degree
UT038-3D	Comen TOCO and US transducer Probe, 3 in 1, 6 pin
UT038-4D	Comen TOCO and US transducer Probe, 3 in 1, 6 pin 40degree
UT038-5B	Commen STAR5000 TOCO transducer Probe, 4 pin
UT072-1A	Edan US transducer Probe, 4 pin
UT072-1B	Edan TOCO transducer Probe, 6 pin,
UT072-1E	Edan US transducer Probe, 4 pin (Original)
UT072-1F	Edan TOCO transducer Probe, 6 pin (Original)
UT072-2A	Edan US transducer Probe, 4 pin 40degree
UT072-2B	Edan TOCO transducer Probe, 6 pin 80degree
UT072-2E	Edan US transducer Probe, 4 pin 40degree(Original)
UT072-3A	Edan US transducer Probe, 6 pin 60degree
UT072-2L	Edan Event marker, 3.5mm Din type
UT002-1E	GE 5700HAX US transducer Probe, 12 pin (Original)
UT002-1F	GE 2264HAX TOCO Probe, 12 pin (Original)
UT002-1A	GE 5700HAX US transducer Probe, 12 pin, COROMETRICS 170 (Compatible)
UT002-1B	GE 2264HAX TOCO transducer Probe, 12 pins, COROMETRICS 170 (Compatible)
UT040-1A	GMI US transducer Probe, 5 pin
UT008-1A	Goldway US transducer Probe, 6 pin
UT008-1B	Goldway TOCO transducer Probe, 6 pin 40degree

P/N	Description
UT008-1L	Goldway Event Marker UT3000A, 6 pin
UT008-2L	Goldway Event Marker, Din 7 pin
UT008-2A	Goldway US transducer Probe, metal 5 pin
UT008-2B	Goldway TOCO transducer Probe, metal 5 pin
UT008-1D	Goldway UT3000A TOCO and US transducer Probe, 3 in 1, round 6 pin
UT008-2D	Goldway UT3000A TOCO and US transducer Probe, 3 in 1, round 7 pin
UT008-2J	Goldway UT3000A US Fetal cable spare part, round 7 pin
UT008-3A	Goldway US transducer Probe, 5 pin 40degree
UT008-4A	Goldway US transducer Probe, Din 7 pin
UT008-4B	Goldway TOCO transducer Probe, Din 7 pin
UT076-2B	Guoteng TOCO transducer Probe, 6 pin 60degree
UT077-1A	Huntleigh/Sonicaid US transducer Probe, 12 pin
UT077-1B	Huntleigh/Sonicaid TOCO transducer Probe, 12 pin
UT157-1D	Luckcome TOCO and US transducer Probe, 3 in 1, 6 pin 40degree
UT068-1A	Sunmind MP-800A US transducer Probe, Big Din 7 pin
UT068-1B	Sunmind MP-800A TOCO transducer Probe, Big Din 7 pin
UT068-1L	Sunmind Marker MP-800A, Big Din 7 pin
UT089-1A	Sunray US transducer Probe, 5 pin
UT089-1B	Sunray TOCO transducer Probe, 4 pin
UT089-1C	Sunray TOCO and US transducer Probe, 3 in 1, 5 pin 40degree
UT004-2A	Philips M1356A US Transducer Probe, 12 pin (Compatible)
UT004-2B	Philips M1355A TOCO Transducer Probe, 12 pin (Compatible)
UT004-1E	Philips M2736A US transducer Probe, 8 pin (Original)
UT004-1F	Philips M2735A TOCO transducer Probe, 8 pin (Original)
UT004-2E	Philips M1356A US transducer Probe, 12 pin (Original)
UT004-2F	Philips M1355A TOCO transducer Probe, 12 pin (Original)
UT058-1B	Unicare TOCO transducer Probe, 5 pin
UT055-5B	Zondan TOCO Transducer Probe, 4 pin
UT055-1B	Zondan Infinity TOCO Transducer Probe, 4 pin 40degree
UT055-2A	Zondan US transducer Probe, 5 pin
UT055-2B	Zondan TOCO Transducer Probe, 6 pin 40degree black color
UT055-4B	Zondan TOCO Transducer Probe, 6 pin 40degree green color
UT055-3A	Zondan US transducer Probe, 5 pin 40degree
UT055-3B	Zondan TOCO Transducer Probe, 5 pin green color
UT001-1N	Disposable Blue Belt for TOCO and US transducer Probe
UT001-2N	Disposable Yellow Belt for TOCO and US transducer Probe
UT001-3N	Disposable Pink Belt for TOCO and US transducer Probe
UT001-4N	Reusable Blue Belt for TOCO and US transducer Probe
UT001-5N	Reusable Gray Belt for TOCO and US transducer Probe



Brand	P/N	OEM Number	Compatible models No.
ALOKA	UU001-1A	UST -934N-3.5	SSD-500/ 620/ 625/650/1100
	UU001-2A	UST-945B-5	SSD-500/ 620/ 625/650/1100
	UU001-3A	UST-981-5	SSD-500/ 620/ 625/650/1100
	UU001-4A	UST-5512U-7.5	SSD-500/ 620/ 625/650/1100
	UU001-5A	UST-5821-7.5	SSD-500/ 620/ 625/650/1100
	UU001-6A	SH-101	SSD-500/ 620/ 625/650/1100
	UU001-7A	UST-9112-5	SSD-900\1000\3500\4000
	UU001-8A	UST-5546	SSD-4000
	UU001-9A	UST-984-5	SSD-900\1000\1700\3500\4000
	UU001-10A	UST-979-3.5	SSD-900\1000\1700\3500\4000
	UU001-11A	UST-990-5	SSD-3500\4000
	UU001-12A	UST-9118	SSD-5000\5500
	UU001-13A	UST-9123	SSD-3500\4000
	UU001-14A	UST-9130	SSD-3500\4000
	UU001-15A	UST-9124	SSD-3500\4000
GE	UU002-1A	C36	LOGIQ 50/100/180
	UU002-2A	CBF	LOGIQ 200 Pro
	UU002-3A	3Cb	LOGIQ 200, LOGIQ 200E, LOGIQ 200PRO
	UU002-4A	3.5C	LOGIQ 3, 5, 5Pro, 6, 7, 9, VIVID 7, 7Pro
	UU002-5A	E8C	LOGIQ3, 5, 7, 9
	UU002-6A	4C	LOGIQ6, 7, 9, P5, S6, VIVID 7/7Pro
	UU002-7A	4C-RC	
	UU002-8A	E8C-RS	Logiq Book XP/Logiq e/Vivid i
	UU002-9A	3C-RS	Logiq Book XP/Logiq e/Vivid i
ESAOTE	UU103-1A	IVT12	AU3 / AU4 / AU5
	UU103-2A	LA14	
	UU103-3A	CA11	AU3 / AU4 / AU5 / Megas / Caris
	UU103-4A	CA621	DU3/4/Caris Plus/My Lab15/20/25/30
	UU103-5A	CA421	DU3/4/Caris Plus/My Lab15/20/25/30
	UU103-6A	CA431	My Lab25/30CV/40/50/GOLD Platform
	UU103-7A	CA631	
	UU103-8A	CA430E	My Lab25/30CV/40/50
	UU103-9A	LA523 10-5	DU3/4/Caris Plus/My Lab15/20/25/30
	UU103-10A	LA522	
	UU103-11A	PA230E	DU3/4/Caris Plus/My Lab15/20/25/30
	UU103-12A	EC123	DU3/4/Caris Plus/My Lab15/20/25/30
PHILIPS	UU004-1A	C4-2	HDI3000
	UU004-2A	C5-2	HD3
	UU004-3A	C5-2	HDI3500/4000/5000
	UU004-4A	C8-4V	HD5/7/9/11
	UU004-5A	C5-2	HD5/7/9/11
	UU004-6A	C9-5EC	HDI 1500/3000/3500/5000
	UU004-7A	C8-4V	HDI 1500/3000/3500/5000
	UU004-8A	L7-4	HDI 1500/3000/3500/5000
	UU004-9A	P3-2	HDI 3000/3500/5000
	UU004-10A	P4-2	HDI3000/3500/4000/5000
ACUSON	UU101-1A	C5-2	G20
	UU101-2A	L10-5	G20
SIEMENS	UU015-1A	3.5C40S	Prima / Adara
	UU015-2A	6.5EV13S	Prima / Adara



Brand	P/N	OEM Number	Compatible models No.
MEDISON	UU104-1A	HC2-5	3200/SA-5500/6600C/7700/8800
	UU104-2A	C3-7ED	SA-5500/6000C/8000
	UU104-3A	EC4-9/10R	SA-5500/6000C/8000
	UU104-4A	L5-9EC	SA-5500/6000C/8000
HITACHI	UU105-1A	PL21	
	UU105-2A	EUP-C314T	EUB-405/410/420/450/515
	UU105-3A	EUP-C314G	EUB-405+420/525/555/6000/6000S
	UU105-4A	EUP-C314	EUB-405/410/420/450/515
	UU105-5A	EUP-C514	EUB-405+420/525/555/6000/6000S
	UU105-6A	EUP-L53S	
	UU105-7A	EUP-L54M	
	UU105-8A	EUP-L34T	EUB-5500/6000/6000S
HONDA	UU106-1A	HCS-436M	2000series
	UU106-2A	HLS-475M	
	UU106-3A	HCS-4710MV	2001series
Toshiba	UU107-1A	PVG-601V	Justvision 200/400/Capacee
	UU107-2A	PVG-720S	
	UU107-3A	PVF-375MT	
	UU107-4A	PVG-366M	SSA-200/400/Capacee
SonoScape	UU107-5A	PVT-375BT	
	UU108-1A	C361	
	UU108-2A	10L1	SSI-2000\5000
	UU108-3A	L741	SSI-1000
	UU108-4A	C344	SSI-2000\5000
	UU108-5A	6V1	SSI-2000\5000
Mindray	UU108-6A	SS-L535	SSI-5500\6500
	UU003-1A	3C5S	M5
	UU003-2A	3C5A	DC-3/DC-6
	UU003-3A	6cv1	DC-3/DC-6
	UU003-4A	35C50HA	DP-9900\9900Plus
	UU003-5A	75L38HA	DP-9900\9900Plus
	UU003-6A	65EC10HA	DP-9900\9900Plus
	UU003-7A	35C50EA	DP-8800Plus\DP-8800\DP-6600
	UU003-8A	65EC10EA	DP-8800Plus\DP-8800\DP-6600
	UU003-9A	75L38EA	DP-8800Plus\DP-8800\DP-6600
	UU003-10A	50L60EAV	DP-6600VET
	UU003-11A	65C15EAV	DP-6600VET
	UU003-12A	75L50EAV	DP-6600VET
	UU003-13A	35C50EB	DP-1100Plus\DP-3300\DP-7700
	UU003-14A	75L38EB	DP-1100Plus\DP-3300\DP-7700
	UU003-15A	65EC10EB	DP-1100Plus\DP-3300\DP-7700
UU003-16A	CA3.5MHz/R60	DP-1100	
Fukuda	UU069-1A	FUT-CS602-5A	UF-4100
HaiYing	UU109-1A	HY7208C3	
TH	UU110-1A	C361	
	UU110-2A	E663	
EMP	UU102-1A	convex	EUP-1100/860
	UU102-2A	linetype	EUP-1100/860
	UU102-3A	cavity	EUP-1100/860
Edan	UU072-1A	cavity	DUS3
	UU072-2A	cavity	DUS6

P/N	Original Part no.	Brand
U938-01A	M-11	International Technologies
U938-01B	M-15	International Technologies
U938-01C	M-03	International Technologies
U938-01D	M-04	International Technologies
U938-01E	M-02	ITG
U938-02A	PSR-11-917M	Analytical Industries Inc
U938-02B	PSR-11-75-KE8	Analytical Industries Inc
U938-02C	PSR-11-75-KE4	Analytical Industries Inc
U938-02D	PSR-11-915-4	Analytical Industries Inc
U938-02E	PSR-11-75-KE250A	Analytical Industries Inc
U938-02F	PSR-11-75-KE7	Analytical Industries Inc
U938-02H	PSR-11-75-KE8	Analytical Industries Inc
U938-02J	PSR-11-917-M2	Analytical Industries Inc
U938-02G	PSR-11-60-08	Analytical Industries Inc
U938-02K	GPR-11-60-RTS	Analytical Industries Inc
U938-03A	MOX-20	City Technology
U938-03B	MOX-2	City Technology
U938-03C	MOX-3	City Technology
U938-03D	MOX-4	City Technology
U938-04A	MAX 10	Maxtec
U938-04B	MAX 12	Maxtec
U938-04C	MAX 250A	Maxtec
U938-04D	MAX 250E	Maxtec
U938-04E	MAX 250B	Maxtec
U938-05A	MX01049	Siemens Drager / OXY Trace / VE

P/N	Original Part no.	Brand
U938-17A	MX01050	Drager
U938-05B	6850645	Siemens Drager
U938-06A	66 40 044	Maquet
U938-07A	OOM201	EnviteC
U938-07B	OOM202	EnviteC
U938-07C	OOM204	EnviteC
U938-07D	OOM102-1	EnviteC
U938-07E	OOM105	EnviteC
U938-07F	OOM102	EnviteC
U938-07G	OOM101	EnviteC
U938-07H	OOM103	EnviteC
U938-07J	OOM103-1	EnviteC
U938-07K	OOM103-1M	EnviteC
U938-07L	OOM104	EnviteC
U938-07M	OOM105	EnviteC
U938-07N	OOM106	EnviteC
U938-07P	OOM107	EnviteC
U938-07Q	OOM107-2	EnviteC
U938-07R	OOM110	EnviteC
U938-07S	OOM202-1	EnviteC
U938-07T	OOM202-2	EnviteC
U938-07U	OOM202-2S	EnviteC
U938-08A	T-7	Teledyne
U938-09A	R-17MED	Teledyne
U938-10A	396200/01	Hamilton
U938-12A	7700	Aeon

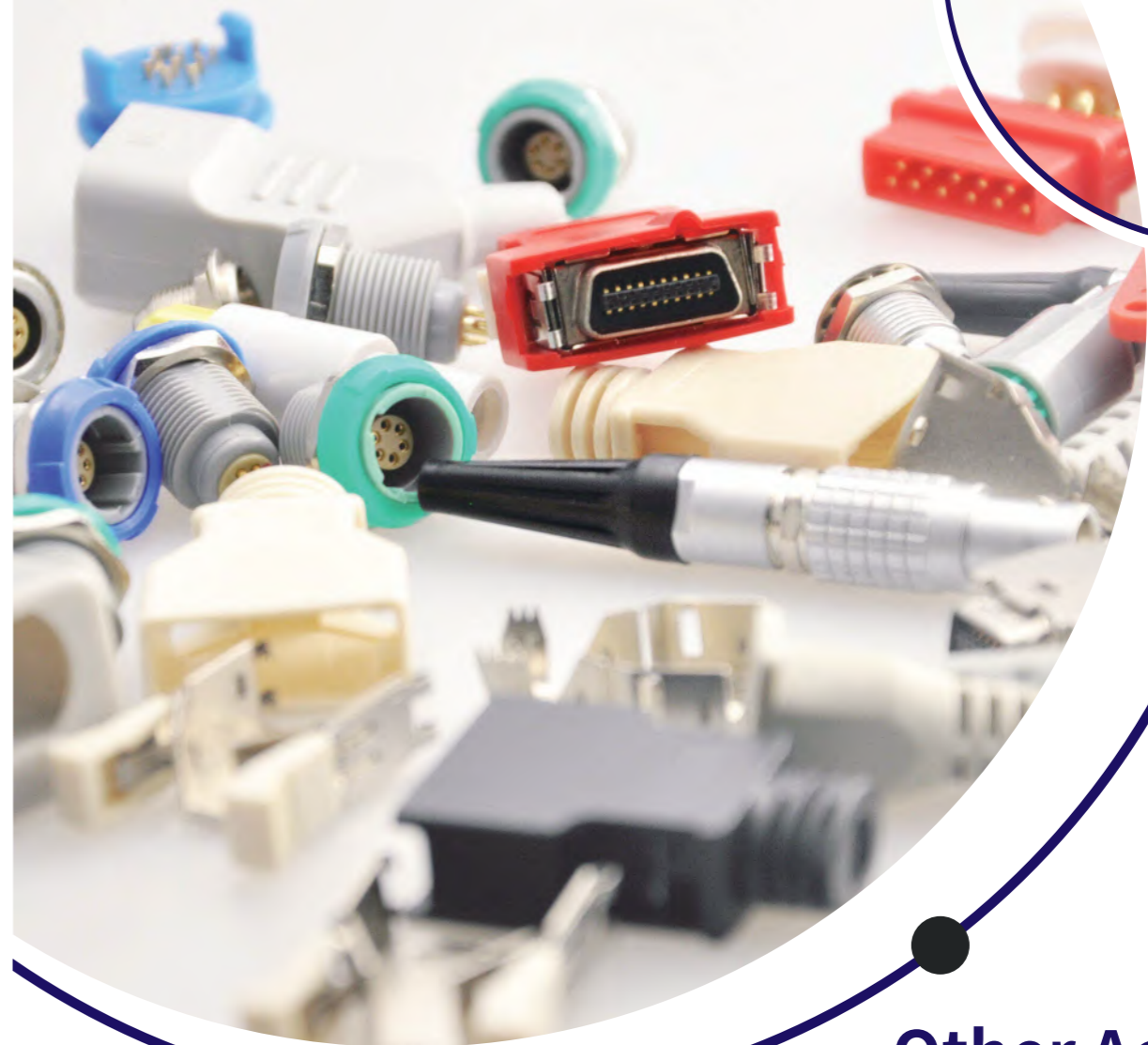

Other Accessories



P/N	Description	Image	MOQ
PC0127A	P series adult finger clip shell set,black rubber with wing		5 sets
PC0127B	P series adult finger clip shell set,black rubber without wing		5 sets
PC0127C	P series adult finger clip shell set,white rubber		5 sets
PC0128C	Nellcor adult finger clip shell set,white rubber,grey tail		5 sets
PC0128A	Nellcor adult finger clip shell set,black rubber with wing,grey tail		5 sets
PC0128B	Nellcor adult finger clip shell set,grey rubber,grey tail		5 sets
PC0129A	Nellcor adult finger clip shell set,black rubber with wing,blue tail		5 sets
PC0129B	Nellcor adult finger clip shell set,grey rubber,blue tail		5 sets
PC0129C	Nellcor adult finger clip shell set,white rubber,blue tail		5 sets
PC0130A	Envitec adult finger clip shell set		5 sets
PC0131A	Dolphin adult finger clip shell set		5 sets
PC0113A	Mindray adult finger clip shell set		5 sets
PR0023D	Normal adult silicone soft tip		5 sets
PC0134A	HP adult silicone soft tip		5 sets
PC0132A	Pediatric finger clip set		5 sets
PC0135A	Pediatric silicone soft tip		5 sets
PC0136A	Infant silicone soft tip		5 sets
PC0137A	Neonate silicone soft wrap		5 sets
PC0138A	Neonate Y type wrap		5 sets
PR0028A	SpO2 White LED and Black PD silicone Spoon		5 sets
PR0028B	SpO2 White and Black ear clip		5 sets

P/N	Description	Image	MOQ
PR0028C	SpO2 White and Black silicone bandage neonate		5 sets
PC0139A	Adult ear clip		5 sets
PC0140A	Veterinary tongue clip - bigger size		5 sets
PC0141A	Veterinary tongue clip - smaller size		5 sets
LED & PD			
PE0035A	Chinese LED - 660/905-2 suitable for Nellcor,Philips Mindray,GE,Siemens...		5 pcs
PE0035B	Korean LED - 660/905-2 suitable for Nellcor,Philips Mindray,GE,Siemens...		5 pcs
PE0035C	American LED - 660/905-3 suitable for Nellcor,Philips,Mindray,GE,Siemens...		5 pcs
PE0035D	American LED - 660/905-2 suitable for Nellcor,Philips,Mindray,GE,Siemens...		5 pcs
PE0036B	Chinese LED - 660/940-3 suitable for Palco...		5 pcs
PE0036D	American LED - 660/940-3 suitable for Ohmeda,Novamatrix,Nihon Kohden...		5 pcs
PE0036E	Chinese LED- 660/940-3 suitable for Ohmeda,Novamatrix,Nihon Kohden...		5 pcs
PE0039A	Chinese PD 660/905/940nm 4P		5 pcs
PE0039B	Korean LED - 660/880/940-4		5 pcs
PE0037A	Chinese PD - 2.5*2.5		5 pcs
PE0037B	Korean PD - 3*3		5 pcs
PE0037C	American PD- 2P 3*3		5 pcs
PE0037D	American PD - 2P 2.5*2.5		5 pcs
PE0038A	Digital PD - 235		5 pcs
PE0038E	Digital PD - 237		5 pcs
PE0033A	Oximax chip,suitable for Nellcor Oximax Sensor		5 pcs

P/N	Description	Image	MOQ
PE0034A	Oximax chip,suitable for One piece Masimo RAD 20-pin sensor		5 pcs
PE0034B	Oximax chip,suitable for Masimo short sensor which require Masimo RAD 20-pin adapter cable		5 pcs
PE0034C	Oximax chip,suitable for Masimo RAD 20-pin adapter cable		5 pcs
PE0079A	Oximax chip,suitable for Corpuls direct cable		5 pcs
Raw Materials Cables & Wires			
PW0001B	5 core SpO2 cable,4.0mm,with shield,TPU,grey		10m
PW0001A	5 core SpO2 cable,4.0mm,with shield,TPU,blue		10m
PW0016B	5 core SpO2 cable,2.5mm,double-wire with shield,TPU,grey		10m
PW0016A	5 core SpO2 cable,2.5mm,double-wire with shield,TPU,blue		10m
PW0021A	4 core disposable SpO2 cable,3.0mm,PVC,white		10m
PW0019A	Single core wire,2.0mm,with shield,TPU,grey		10m
PW0026A	Single core wire,2.0mm,without shield,TPU,grey		10m
PW0018A	Single core wire,2.6mm,with shield,TPU,grey		10m
PW0022A	Single core wire,3.0mm,with shield,TPU,grey		10m
PW0003A	5 core ECG cable,5.0mm,with shield,TPU,grey		10m
PW0009B	10 core ECG Cable,6.0mm, with shield,TPU,grey		10m
Semi-finished Sensor			
SP0031A	SpO2 adult finger clip with cable,suitable for Nellcor,GE,Mindray,Philips,Siemens,Masimo...,TPU,grey,2.8m		5 pcs
SP0041A	SpO2 adult finger clip with cable,suitable for Nihon Kohden,Ohmeda,MEK,Novamatrix,TPU,grey,2.8m		5 pcs
SP0042A	SpO2 adult finger clip with cable for 660/940,grey (Envitec L-Series)		5 pcs
SP0034A	SpO2 adult silicone tip with cable,suitable for Nellcor,GE,Mindray,Philips,Siemens,Masimo...,TPU,grey,2.8m		5 pcs
SP0044A	SpO2 adult silicone tip with cable,suitable for Nihon Kohden,Ohmeda,MEK,Novamatrix,TPU,grey,2.8m		5 pcs

P/N	Description	Image	MOQ
SP0035A	SpO2 pediatric finger clip with cable for 660/940,TPU,grey,2.8m		5 pcs
SP0038A	SpO2 neonate silicone wrap with cable for 660/905,double-wire,grey,2.8m		5 pcs
SP0078B	Nellcor Oximax 9-pin SpO2 molded cable,TPU,grey,2.8m		5 pcs
SP0115A	Siemens 7-pin SpO2 molded cable,TPU,blue,2.8m		5 pcs
SP0066A	Nihon kohden 9-pin SpO2 molded cable,TPU,grey,2.8m		5 pcs
SP0074A	HP 12-pin SpO2 molded cable,TPU,Blue,2.8m		5 pcs
SP0072A	HP 8-pin SpO2 molded cable,TPU,blue,2.8m		5 pcs
SP0080A	Biolight M7000 9-pin SpO2 molded cable,TPU,grey,2.8m		5 pcs
SP0082A	Biolight M7000 12-pin SpO2 molded cable,TPU,grey,2.8m		5 pcs
SP0086A	Masimo 9-pin SpO2 molded cable,TPU,grey,2.8m		5 pcs
SP0088A	CSI 6-pin SpO2 molded cable,TPU,grey,2.8m		5 pcs
SP0090A	Nonin 9-pin SpO2 molded cable,TPU,grey,2.8m		5 pcs
SP0092A	Datex 10-pin SpO2 molded cable,TPU,grey,2.8m		5 pcs
SP0097A	GE-Nellcor 11-pin SpO2 molded cable,TPU,grey,2.8m		5 pcs
SP0103A	Mindray 12-pin SpO2 molded cable,TPU,grey,2.8m		5 pcs
SP0111A	MEK 6-pin SpO2 molded cable,TPU,grey,2.8m		5 pcs
SpO2 Connector			
PC0142A	Nellcor 9-pin connector ,purple		5 sets
PC0078A	HP 8-pin connector (philips module)		5 sets
PC0078B	HP 8-pin connector (masimo module)		5 sets
PC0164A	Biocare 10-pin connector,blue		5 sets
PC0154B	Biolight M series 12-pin connector		5 sets

P/N	Description	Image	MOQ
PC0064B	GE 11-pin connector (nellcor module)		5 sets
PC0064E	GE 11-pin connector (masimo,oximax,ohmeda module)		5 sets
PC0086C	GE Hellige 10-pin connector		5 sets
PC0066A	GE-Trusat 9-pin connector		5 sets
PC0112A	GE-Trusignal 9-pin connector		5 sets
PC0112B	GE-Trusignal 9-pin female connector		5 sets
PC0042A	Ohmeda Oxy-tip 8-pin connector		5 sets
PC0043A	Ohmeda Oxy-tip 8-pin female connector		5 sets
PC0146B	Choice 9-pin connector		5 sets
PC0100C	DOC-10 AMP 14-pin connector, blue		5 sets
PC0146B	Datex 10-pin connector		5 sets
PC0087A	Lohmeier 12-pin connector		5 sets
PC0101C	Masimo AMP 20-pin connector,red		5 sets
PC0101A	Masimo AMP 20-pin connector,Ivory		5 sets
PC0083A	Masimo LNOP 6-pin female connector		5 sets
PC0083B	Masimo LNOP 8-pin female connector		5 sets
PC0143A	Masimo 11-pin connector,white		5 sets
PC0143B	Masimo 11-pin female connector,white		5 sets
PC0099B	Mindray T5 7-pin connector (nellcor module)		5 sets
PC0099A	Mindray T5 7-pin connector (masimo module)		5 sets
PC0116B	Mindray T5 8-pin connector (oximax module)		5 sets

P/N	Description	Image	MOQ
PC0116A	Mindray T5 8-pin connector (masimo oximax module),purple		5 sets
PC0111B	Mindray 12-pin connector		5 sets
PC0126A	Mennen 8-pin connector		5 sets
PC0109A	Nihon Kohden round 10-pin connector		5 sets
PC0101B	Nihon Kohden AMP 20-pin connector,black		5 sets
PC0110A	Nihon Kohden rectangle 14-pin connector		5 sets
PC0168A	Nihon Kohden AMP 20-pin connector,blue		5 sets
PC0067C	M&B 6-pin connector,white		5 sets
PC0178A	M&B 7-pin connector		5 sets
PC0067B	Ohmeda,M&B 7-pin connector,white		5 sets
PC0067A	Ohmeda,M&B 7-pin connector,black		5 sets
PC0069A	Spacelabs 7-pin connector,black		5 sets
PC0068A	Novamatrix,Dixtal 7-pin connector,black		5 sets
PC0082A	Spacelabs 10-pin connector (nellcor module)		5 sets
PC0082E	Spacelabs 10-pin connector (masimo module)		5 sets
PC0079A	Siemens 7-pin connector		5 sets
PC0125A	Zoncare 6-pin connector		5 sets
PC0063A	Pace Tech 5-pin connector		5 sets
PC0097A	Schiller 7-pin connector		5 sets
PC0096A	Baozhong 5-pin connector		5 sets
PC0062A	Datascope 8-pin connector		5 sets

P/N	Description	Image	MOQ
PC0049B	Biosys 7-pin connector		5 sets
PC0008B	Metal 4-pin connector		5 sets
PC0008F	Metal 4-pin 0B connector		5 sets
PC0032A	Metal 5-pin connector		5 sets
PC0036A	Metal 6-pin connector		5 sets
PC0038A	Metal 7-pin connector		5 sets
PC0040A	Metal 8-pin connector		5 sets
PC0025C	Metal 10-pin connector		5 sets
PC0026B	Metal 14-pin connector		5 sets
PC0006A	Lemo 2-pin single notch connector,black tail		5 sets
PC0006B	Lemo 2-pin single notch connector,green tail		5 sets
PC0008C	Lemo 4-pin 40 degree connector,long yellow tail		5 sets
PC0001A	Lemo 5-pin single notch connector,green tail		5 sets
PC0001C	Lemo 5-pin single notch connector,yellow tail		5 sets
PC0001D	Lemo 5-pin single notch connector,white,green tail		5 sets
PC0012A	Lemo 5-pin 40 degree connector		5 sets
PC0003B	Lemo 5-pin 80 degree connector		5 sets
PC0002A	Lemo 6-pin single notch connector		5 sets
PC0005B	Lemo 6-pin 40 degree connector,grey		5 sets
PC0005C	Lemo 6-pin 40 degree connector,white		5 sets
PC0013A	Lemo 6-pin 60 degree connector		5 sets

P/N	Description	Image	MOQ
PC0017B	Lemo 6-pin 80 degree connector		5 sets
PC0018A	Lemo 7-pin single notch connector		5 sets
PC0018B	Lemo 7-pin 60 degree connector		5 sets
PC0020A	Lemo 8-pin single notch connector		5 sets
PC0020B	Lemo 8-pin single notch connector		5 sets
PC0021A	Lemo 8-pin 60 degree connector		5 sets
PC0023A	Lemo 8-pin 40 degree connector,green		5 sets
PC0023C	Lemo 8-pin 40 degree connector,red		5 sets
PC0024A	Lemo 9-pin single notch connector		5 sets
PC0025A	Lemo 10-pin single notch connector		5 sets
PC0026A	Lemo 14-pin single notch connector		5 sets
ECG Assemble Parts			
PC0145A	Universal 6-pin connector		5 sets
PC0147A	HP 8-pin connector		5 sets
PC0111A	HP 12-pin connector		5 sets
PC0108A	Nihon Kohden 8-pin connector		5 sets
PC0073A	Nihon Kohden 11-pin connector		5 sets
PC0072A	Nihon Kohden 12-pin connector		5 sets
PC0155A	Saadat 6-pin connector		5 sets
PC0155C	Saadat 7-pin connector		5 sets
PC0155C	Saadat 8-pin connector		5 sets
PC0146A	Datex 10-pin connector		5 sets

P/N	Description	Image	MOQ
PC0169A	Drager ECG 6-pin connector		5 sets
PC0171A	Drager 16-pin connector, grey		5 sets
PC0064D	GE Marquette 11-pin connector		5 sets
PC0086A	GE Hellige 10-pin connector		5 sets
PC0114A	Spacelabs 17-pin connector		5 sets
PC0154A	Biolight M series 12-pin connector		5 sets
PC0154D	Biolight A series 12-pin connector		5 sets
PC0165A	Infinium 12-pin connector		5 sets
PC0173A	Primedic 16-pin connector		5 sets
PC0174A	Welch Allyn 9-pin connector		5 sets
PC0124A	Mindray Datascope 12-pin connector		5 sets
PC0074A	HP junction box, M1669A style, 3-lead		5 sets
PC0075A	HP junction box, M1668A style, 5-lead		5 sets
PC0081B	Spacelabs junction box, Tru-link style, 3-lead		5 sets
PC0081A	Spacelabs junction box, Tru-link style, 5-lead		5 sets
PC0148A	HP AA plug, 3-lead		5 sets
PC0148B	HP AA plug, 5-lead		5 sets
PC0076A	HP M1669A plug, 3-lead		5 sets
PC0077A	HP M1668A plug, 5-lead		5 sets
PC0077B	HP plug, 5-lead		5 sets
PC0149A	Siemens Euro plug, 3-lead		5 sets

P/N	Description	Image	MOQ
PC0149B	Siemens Euro plug, 5-lead		5 sets
PC0150A	Nihon Kohden BR-903P plug, 3-lead		5 sets
PC0176A	GE-VS 20-pin EKG female connector, 10 lead		5 sets
PC0192A	HP EKG female connector, 10 lead		5 sets
IBP Assemble Parts			
PC0090A	Datascope 6-pin IBP connector		5 sets
PC0079C	Drager 7-pin IBP connector		5 sets
PC0070A	Drager 10-pin IBP connector		5 sets
PC0064A	GE 11-pin IBP connector		5 sets
PC0086B	Hellige 10-pin IBP connector		5 sets
PC0111C	HP 12-pin IBP connector		5 sets
PC0110B	Nihon Kohden 14-pin IBP connector		5 sets
Socket			
PC0007B	Metal 2-pin female socket		5 sets
PC0031A	Metal 3-pin female socket		5 sets
PC0009B	Metal 4-pin female socket		5 sets
PC0034B	Metal 5-pin female socket (0B size)		5 sets
PC0033A	Metal 5-pin female socket (1B size)		5 sets
PC0035A	Metal 5-pin female socket		5 sets
PC0036B	Metal 6-pin female socket		5 sets
PC0039A	Metal 7-pin female socket		5 sets
PC0040B	Metal 8-pin female socket		5 sets

P/N	Description	Image	MOQ
PC0025D	Metal 10-pin female socket		5 sets
PC0027B	Metal 14-pin female socket		5 sets
PC0007A	Lemo 2-pin single notch female socket		5 sets
PC0029A	Lemo 3-pin single notch female socket		5 sets
PC0009A	Lemo 4-pin single notch female socket		5 sets
PC0010A	Lemo 5-pin single notch female socket		5 sets
PC0011A	Lemo 5-pin 40 degree female socket		5 sets
PC0004A	Lemo 5-pin 80 degree female socket		5 sets
PC0015A	Lemo 6-pin single notch female socket		5 sets
PC0016A	Lemo 6-pin 40 degree female socket		5 sets
PC0014A	Lemo 6-pin 60 degree female socket		5 sets

P/N	Description	Image	MOQ
PC0017A	Lemo 6-pin 80 degree female socket		5 sets
PC0019A	Lemo 7-pin single notch female socket		5 sets
PC0019B	Lemo 7-pin 40 degree female socket		5 sets
PC0022A	Lemo 8-pin single notch female socket		5 sets
PC0024B	Lemo 9-pin single notch female socket		5 sets
PC0025B	Lemo 10-pin female socket		5 sets
PC0027A	Lemo 14-pin female socket		5 sets
PC0153A	IBP large 6-pin socket, red		5 sets
PC0151A	ECG large 6-pin socket, black		5 sets
PC0152A	ECG large 5-pin socket, black		5 sets
PC0151B	ECG small 6-pin socket, black		5 sets

EEG Electrodes and cord			
P/N	Description	Plug side	Patient side
U905-1AA	Tooth type clip EEG cord, with copper, L=1.5m		
U905-1BB	Cup electrode EEG cord, with golden, L=1.5m		
U905-2AA	Tooth type clip EEG cord, with copper, L=1.5m		
U905-2BB	Cup electrode EEG cord, with golden, L=1.5m		
U905-3AA	Tooth type clip EEG cord with copper, L=1.5m		
U905-3BB	Cup electrode EEG cord, with golden, L=1.5m		
ESU Pencil and Patient return plate cable			
U906-1A	Patient return plate cable, L=3M, plug: 2.35 jack with metal pin, Gray		
U906-1B	Patient return plate cable, L=3M, plug: 6.35 Plug, Gray		

P/N	Description	Image
U906-1C	Patient return plate cable, L=3M, plug: 2.35 jack without metal pin, Gray	
U906-2A	Patient return plate cable, L=3M, plug: 2.35 jack with metal pin, Blue	
U906-2B	Patient return plate cable, L=3M, plug: 6.35 Plug, Blue	
U906-2C	Patient return plate cable, L=3M, plug: 2.35 jack without metal pin, Blue	
U907-1A	Electrosurgical Bipolar Cable, L=3M, Gray	
U907-1B	Bipolar Electrode cable, L=3M, Plug: 2, banana plug	
U907-2A	Bioplar Forcep	

P/N	Description	Image
U907-2B	Electrosurgical Bipolar Cable with Forcep	
U907-2C	Electrosurgical Bipolar Cable with Forcep	
U908-1A	Disposable Electrosurgical pencil,handle=170mm, Length of blade=40mm,L=3M	
U909-1A	Disposable Electrosurgical adult patient plate-Monopolar	
U909-2A	Disposable Electrosurgical adult patient plate-Bipolar	
U909-1B	Disposable Electrosurgical child patient plate-Monopolar	
U909-2B	Disposable Electrosurgical child patient plate-Bipolar	
U909-3A	Disposable Monopolar Cable with Monopolar Pad	
U909-4A	Disposable Bipolar Cable with Bipolar Pad	
Pulse Oximeter		
U911-A1A	Fingertip Pulse Oximeter,Red	
U911-A1B	Fingertip Pulse Oximeter,Blue	
U911-A1C	Fingertip Pulse Oximeter,Gray	
U911-A1D	Fingertip Pulse Oximeter,Green	
U911-C2B	Bluetooth fingertip Pulse Oximeter,Blue	
U916-A1A	UpnMed hand-held Pulse Oximeter,130*58*27.5, White	
U911-C1E	Hand-held Pulse Oximeter,Yellow	

Blood pressure monitor		
P/N	Description	Image
U912-A1A	Electronic Blood Pressure Monitor with voice function	
U912-A1B	Fully Automatic Electronic Blood Pressure Monitor	
U912-A2A	Electronic Blood Pressure Monitor	
U912-A2B	Electronic Blood Pressure Monitor	
U912-A2C	Electronic Blood Pressure Monitor	
Micro Air Pump and Valve		
U931-1A	Micro Air Pump,3V,round shape type	
U931-1B	Micro Air Pump,6V,round shape type	
U931-1C	Micro Air Pump,12V,round shape type	
U931-1D	Micro Air Pump,24V,round shape type	
U931-3A	Micro Air Pump, Type,3V,T shape type	
U931-3B	Micro Air Pump,6V,T shape type	
U931-3C	Micro Air Pump,12V,T shape type	
U931-2A	Electromagnetism Valve,3V	
U931-2B	Electromagnetism Valve,6V	
U931-2C	Electromagnetism Valve,12V	
U931-2D	Electromagnetism Valve,24V	
U931-4A	Original MEC-1000 Micro Air Pump,12V	
PN0032A	Medical rubber bulb with valve	
PN00041A	Valve for black rubber bulb	

Other accessories		
P/N	Description	Image
U933-A1A	SKX-2000A ECG simulator	
U933-A1B	SKX-2000G ECG simulator	
U933-A2A	SKX-1000 oxygen probe detector	
U933-A2B	SKX-1000D SpO2 Simulator	
U933-A3A	SKX-1000E SpO2 ECG simulator	
U934-2A	Digital SpO2 Module	
U935-1A	Medical stethoscope	
U936-1A	Reusable Pressure Infusion Bag,500ml	
U936-1B	Reusable Pressure Infusion Bag,1000ml	
U937-06A	Original GE Datex 7900 flow sensor	
U937-15A	Original Drager flow sensor	
U937-127A	Hamilton adult flow sensor	
U937-127B	Hamilton neonate flow sensor	

P/N	Description	Image
U939-02A	GE 733910-HEL D-lite Sensor, reusable, adult	
U961-01A	Adult etCO2 Sensor Airway Adapter	
U961-01B	Pediatric etCO2 Sensor Airway Adapter	
U961-03A	etCO2 Sampling line,Adult/Pediatric	
U961-03B	Mindray T8 CO2 sensor,12pins	
U961-04A	Philips CO2 sensor,M2501,8pins	
U961-128A	Sidestream etCO2 sensor Airway Adapter kit with Dehumidification Tubing	
U961-08A	Goldway CO2 sensor,UT4000F pro BA210,8pins	
U961-08B	Goldway M1921A CO2 sensor,UT4000B,8pins	
U962-02A	Original GE D-fend water trap,black,876446-HEL	
U962-02B	Original GE D-fend Pro water trap,dark steel blue, M1182629	
U962-03A	Compatible Mindray adult water trap	
Battery		
P/N	Description	Image
U932-02A	Compatible GE SM 201-6 battery,5200mah	
U932-02B	Compatible GE Pro1000 battery	

P/N	Description	Image
U932-02C	Compatible GE Cardioserv battery,9715680011, 12V,1300mAh	
U932-02D	Compatible GE 2500 Li-ion battery	
U932-02E	Compatible GE Marquette Responder 3000 battery	
U932-02F	Compatible GE DR201 battery, 11.1V,4500mAh/50Wh	
U932-02G	Compatible GE Dash5000 battery	
U932-02H	Compatible GE Dash2500 NiMh battery,Voltage:8.4V,8000mAh,Size:117*34*69mm	
U932-02J	Original GE Dash4000 battery,11.1V,5200mah	
U932-03A	Compatible Minray T5 Rechargeable Li-ion battery,DC11.1V,4500mAh	
U932-03B	Compatible Mindray Rechargeable sealed lead-acid battery,12V,2.3AH	
U932-03C	Compatible Mindray D6 Li-ion battery	
U932-03D	Original Mindray IMEC series rechargeable Li-ion battery,11.1V,2600Mah,28.6wh	
U932-03E	Compatible Mindray D3 rechargeable sealed lead-acid battery,14.8V,3000mAh	
U932-03F	Original Mindray BeneHeart D3 battery,14.8V,3000mAh	
U932-03G	Compatible Mindray VS800 battery,11.1V,4400mAh	
U932-03H	Compatible Mindray IMEC8 Li-ion battery,11.1V,2600mAh	
U932-03J	Original Mindray D6 battery,15.1V,5600mAh,84.56Wh	
U932-03K	Compatible IPM10 Li-ion battery,11.1V,4500mAh	
U932-03L	Compatible Mindray PM-60,Li-ion battery,3.7V,1800mAh	
U932-04A	Original HP 989803167281 Hearstart XL+ Li-ion battery,14.8V,6.6Ah,98WH	
U932-04B	Original HP M4605A Li-ion battery 989803135861	
U932-04C	Original HP M3538A battery,14.4V,91WH model:Heartstart Mrx	
U932-04D	Compatible HP M4735A battery	
U932-04E	Original HP M4735A Heartstart XL defibrillator medical battery,12V,2300mAh 2.3WH	
U932-04F	Compatible HP Heartstart XL M3516A battery,12V,2.3A	
U932-04G	Original HP Heartstart XL M3516A battery,12V,2Ah	
U932-04H	Original HP M1758A battery,12V,4500mAh	
U932-04J	Compatible HP VM4 battery,11.1V,7.2mAh	
U932-04K	Original HP DFM100 989803190371 battery,4.8V,5Ah	
U932-04L	Compatible HP M4604A Li-ion battery,10.8V	
U932-04M	Compatible HP MP30 Li-ion battery,10.8V	
U932-04N	Original HP 989803194541 battery for MP20,ME202EK,11.1V	
U932-04P	Compatible HP VM6 Li-ion battery,7200mAh,7.8WH	

P/N	Description	Image
U932-05B	Compatible Nihon kohden BSM2301K patient monitor battery	
U932-05C	Compatible Nihon Kohden PVM-2701 battery	
U932-05D	Compatible Nihon Kohden NKB-301V ecg machine battery,12V,2800mAh	
U932-05E	Compatible ECG-1150 ECG machine battery,12V,1950mAh	
U932-05F	Compatible Nihon Kohden 9020P battery,12V,1.9Ah	
U932-10A	Compatible Creative UP8000 Patient monitor battery,12V,4.5AH	
U932-10B	Compatible Creative Deluxe-100 battery with wire,12V,2.4Ah	
U932-15A	Compatible Drager patient monitor battery,NiMh 12V/2500mAh	
U932-38A	Compatible Comen CM1200B ecg machine battery,14.8V,2200mAh	
U932-46A	Compatible Biocare ECG-3010 Li-ion battery, 4.8V,1550mAh,HYLY-947	
U932-47A	Compatible ZOLL 1600,2000 battery,PD4410	
U932-48A	Compatible Contec CMS9000 Li-ion battery,12V,2000mAh	
U932-69A	Compatible Fukuda 8-HRAAFD HHP-13F8G1 NI-MH 9.6V Battery	
U932-69B	Original Fukuda FX-7402 EKG machine battery	
U932-72A	Compatible Edan Li-ion battery 14.8V,2600mAh	
U932-72B	Compatible Edan TWSLB-002 patient monitor battery,14.8V,2500mAh	
U932-72C	Compatible ECG Machine Ni-Mh battery,7.2V,2000mAh/14.4Wh	
U932-94A	Compatible Primedic Akku 14.4DC/3.0Ah/Nimh battery	
U932-94B	Original Primedic M250 Li-ion battery	
U932-94C	Original Primedic M290 Li-ion battery	
U932-138A	Compatible Cadnica patient monitor Li-ion battery,8N-1200SCK,9.6V,1200mAh	
U932-139A	Compatible National patient monitor battery,P-10S/F24G2,9.6V,1000mAh	
OEM-90053A	Compatible Marquet Servo i 6487180 battery,used on Ventilator	



OEM/ODM SpO₂ sensor, ECG cable ,EKG cable ...etc.



Different brands of ECG Cable,SpO₂ sensor
 Kinds of Medical Cables ODM/OEM service
 To develop and design services for customized SpO₂ Module,
 ECG Module

Core competitiveness

- Complete product specifications
 - Stable quality
 - Competitive price
 - On time delivery rate
- Complete Certificates, without much barriers access to the world-market
 Undertake processing, OEM processing, original design processing services
 Short cycle of the New product development (With professional researchers, laboratories and mold processing workshop)

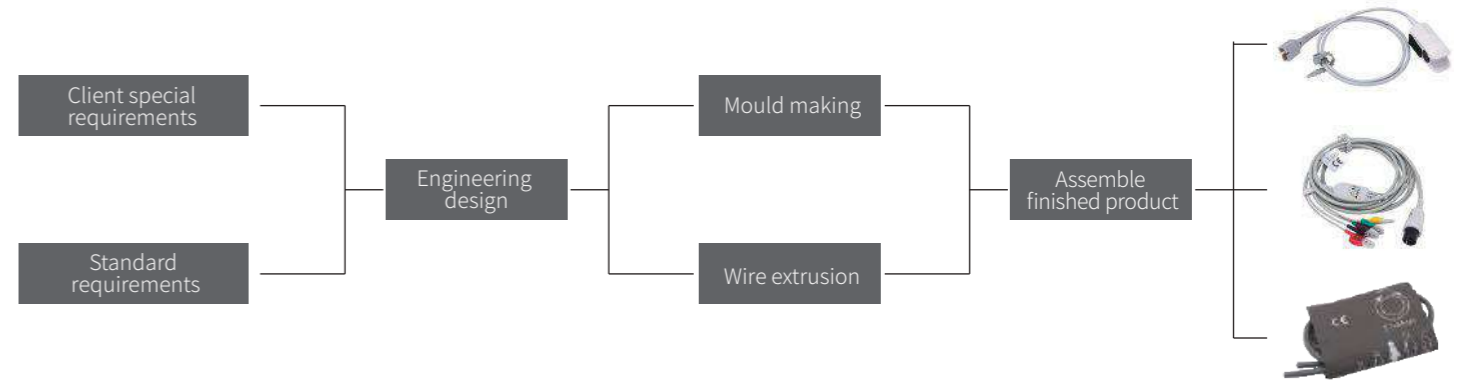

Strict test standards





AP2 UG (haftungsbeschränkt)

Erich-Ollenhauer-Str.12

51377 Leverkusen

Handelsregister: HRB 111772 Registergericht: Amtsgericht Köln

Vertreten durch: Paul Stamirski, Anton Zirnow

Telefon: +49 (0) 214 690 58 414

Email: info@ap2.tech