



Anesthesia Circuit

Your Most Trusted
Health Partner





CONTENTS

09

Anesthesia Circuit

18

Oropharyngeal Airway

20

Face Mask

23

Heat and Moisture exchange filter
(HMEF) & Filter

32

Breathing Bag

34

Accessories (Tubing, Connectors, Valves
and Other Supporting Items)

38

Product Index

40

Symbols and Cleaning Instructions



Anesthesia Circuit

Anesthesia Breathing Circuit & Accessories	06
Durable Anesthesia Circuit	10
ECO Anesthesia Circuit	11
Standard Anesthesia Circuit	12
Swivel Anesthesia Circuit	13
Theta Anesthesia Circuit	14
Bain Circuit	15
Coaxial Anesthesia Circuit	16
Jackson Rees Anesthesia Circuit	17
Guedel Airway Management Kit	19
Berman Airway Management Kit	19
Sil-Flex™ Silicone Mask	21
Air-soft™ Aircushion Mask	21
Endo Mask	22
Heat and Moisture Exchanger (HME)	26
Heat and Moisture Exchanger Filter (HMEF)	27
Heat and Moisture Exchanger Filter (Filter)	29
Tracheal Heat and Moisture Exchanger (tHME)	30-31
Breathing Bag (Silicon/ Latex-Free/ Latex)	33
Tail-End Control Valve	35
ADU Connector	35
Washington T-Piece	35
Gas Sampling Line	36
ERGO Fixtures	36

Your Best Choice for Anesthesia Circuit

Anesthesia Circuit can be best described as the lifeline between the patient and anesthesia workstation. It consists of various combinations of interfaces, enabling the delivery of anesthetic gases to the patients to be in a consistent and highly regulated manner. Hence, we provide a wide range of devices to equip you with tools to deliver the best outcome to you.

Galemed provides a comprehensive line of products and technologies for anesthesia. The improved design makes it convenient to use and also maintains the outstanding quality that healthcare professionals rely on.



Anesthesia Breathing Circuits & Accessories

Airway Management

Airway management is an important first step in the domain of mechanical ventilation and anesthesia. It directly impacts on the safety of patients. We offer a range of Berman and Guedel airways that are safe, effective and able to provide greater flexibility to healthcare professionals.



Anesthesia Circuits

Our anesthesia circuits are available in durable and disposable models. We also provide fixed or adjustable lengths for the disposable models for more flexibility. To provide a combination that best suits your needs, a wide selection of circuits and accessories are also available.



Face Masks

Face mask is another important aspect in respiratory care. We also designed face masks a step further by incorporating a port onto the mask that allows the insertion of measuring tubes, nasogastric tubes or endoscopy tubes.



Heat and Moisture Exchange Filters (HMEF) & Filters

Respiratory humidification and cross-infection prevention are crucial in mechanical ventilation and anesthesia. We deliver a wide range of HMEF and Filters to provide humidification to the inhaled air for enhanced patient comfort, while minimizing the risk of cross-infection.



Breathing Bags

In addition to the standard latex options in the market, we also supply non-latex and silicone breathing bags to mitigate the risk of allergic reactions in patients. The bags come in volumes ranging from 0.5 liter to 3 liter.



Manual Resuscitators

We provide both durable and disposable manual resuscitators. The resuscitator bag volumes are specifically designed to suit neonate, infant, pediatric and adult patients. For more information on the product, please have a look at the catalog of Airway Management.



▼ Tubing, Connectors, Valves and Other Supporting Items

We have an extensive range of accessories, components and connectors to provide clinicians or healthcare professionals with the option to customize a setup to meet patient's needs. Pressure valves, monitoring devices, tubing or device holders are also available to provide support for clinical operation.



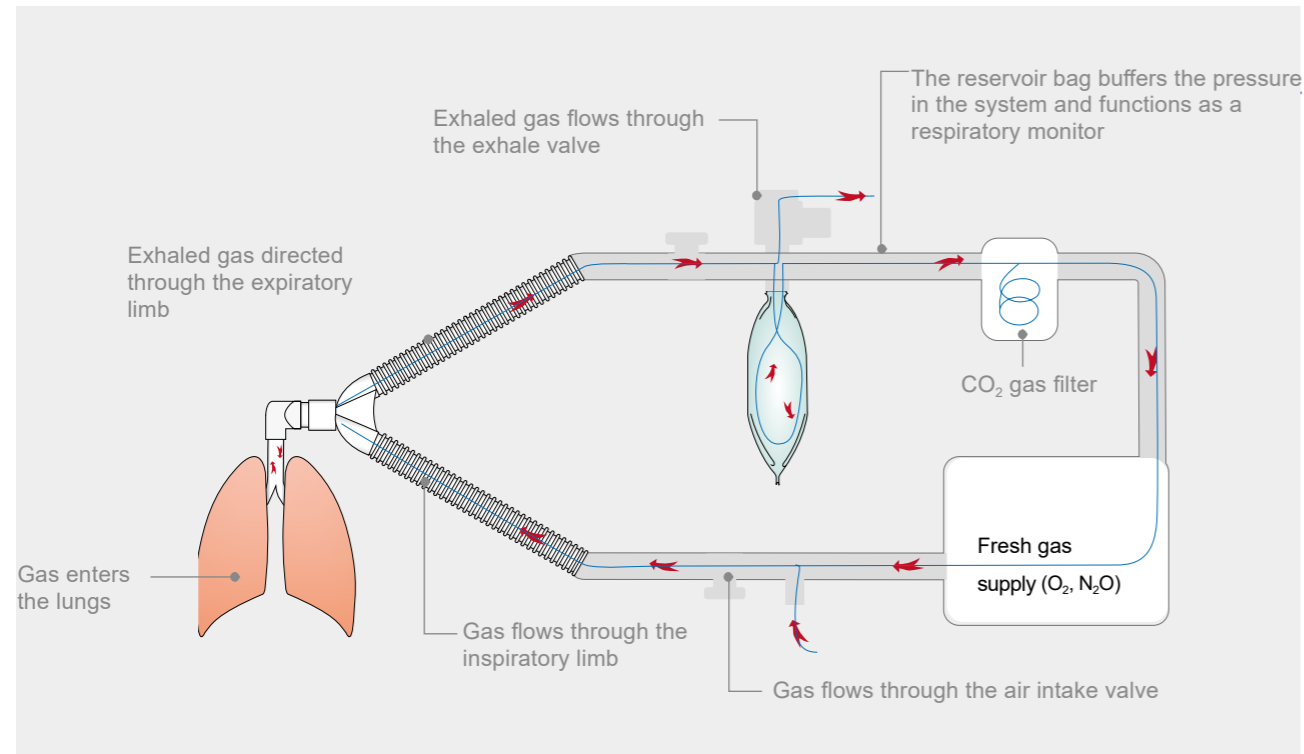

Closed Anesthesia Breathing Systems generally consist of the following parts: a fresh gas supply and inspiratory limb, a patient interface, an expiratory conduit, a breathing bag, an adjustable pressure limiting (APL) valve and a CO₂ filter. A closed system interface enables the complete re-breathing of exhaled air at a lower gas flow rate.

▲ Types of Closed Anesthesia Breathing Systems Available:

- ECO Anesthesia Circuit
- EVA Circuit

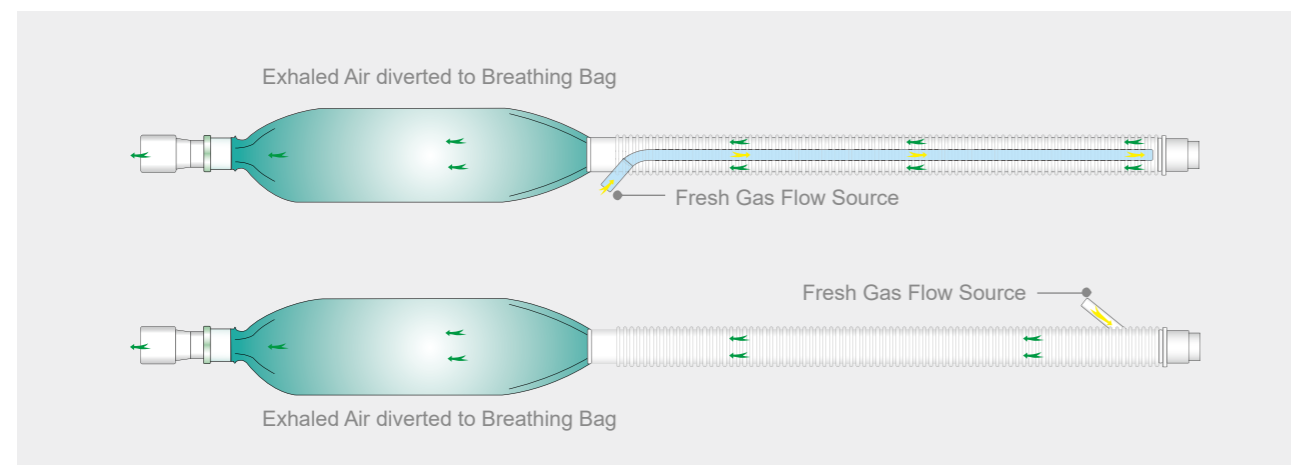

Semi-Open Anesthesia Breathing Systems generally consist of the parts shown in the illustration above. Our semi-open systems are convenient, lightweight and easily scavenged. It has minimal dead space, low airflow resistance and reduces the work of breathing.

▲ Types of Semi-Open Anesthesia Breathing Systems Available:

- Theta, Bain and Coaxial Circuit
- Jackson Rees Anesthesia Circuit



Anesthesia Circuit



Durable Anesthesia Circuit



- Materials: polysulfone for plastic components, silicone rubber for tubing and cuff, conform to ISO-10993-1.
- Tubing cuffs designed for firm and sturdy connect.
- Smoothbore tube for clean with minimal air turbulence in the circuit.
- Kink structure to ensure safety and smooth airflow.
- All parts autoclavable at 134°C.
- Biocompatible & ISO conformance.

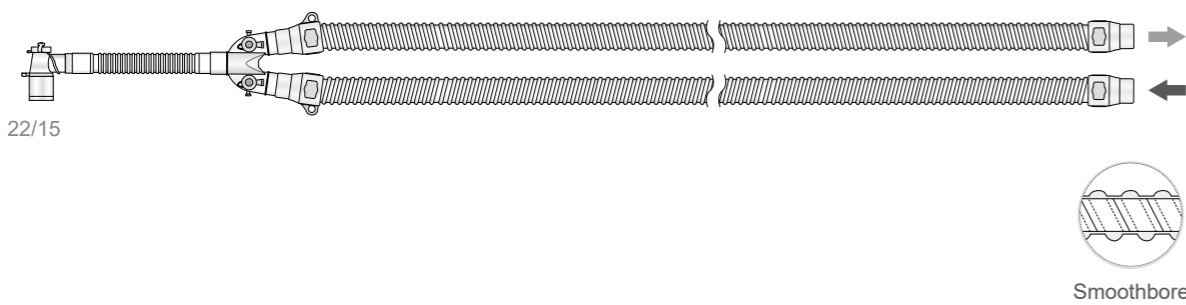

REF	Application	Elbow	Wye	Inhale	Exhale	QTY
AB0040	Adult	22/15 with Luer	22/15, 22M	120 cm, 22F	120 cm, 22F	10 pcs/carton
AB0041	Child	22/15 with Luer	22/15, 15M	120 cm, 15F	120 cm, 15F	10 pcs/carton

Dimensions:

- Breathing circuit: conform to ISO 5367
- Patient port: 22/15 mm conform to ISO 5356-1
- Gas Sampling Port: Luer, conform to ISO 594-1

Optional Accessories:

- Anesthesia Masks and Endoscopy Masks HMEF and Filters
- Gas Sampling Line
- Silicone Breathing Bag: 3L, 2L, 1L, 0.5L

ECO Anesthesia Circuit



- Collapsible & Lightweight.
- Elbow with built-in 4.3 luer port for gas sampling.
- Single Patient Use, conform to ISO-10993-1.
- Biocompatible & ISO conformance.

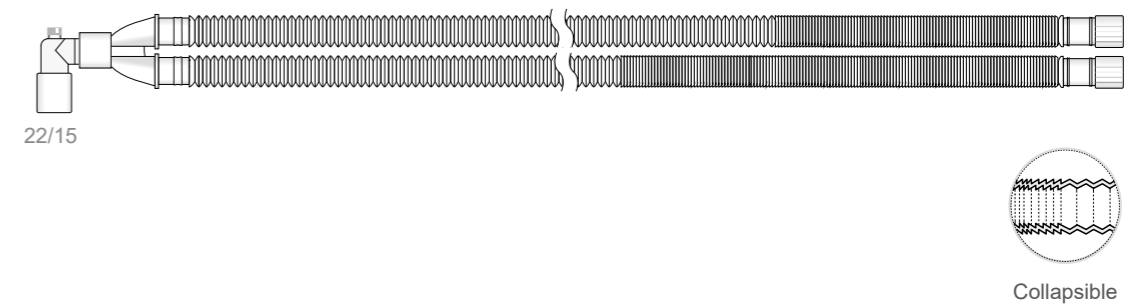

REF	Application	Elbow	Wye	Inhale	Exhale	QTY
AB0231	Adult	22/15 with Luer	22/15, 22M	42-150 cm, 22F		50 pcs/carton
AB0043	Child	22/15 with Luer	22/15, 15M	42-150 cm, 15F		50 pcs/carton

Dimensions:

- Breathing circuit: conform to ISO 5367
- Patient port: 22/15 mm conform to ISO 5356-1
- Gas sampling port: Luer, conform to ISO 594-1

Optional Accessories:

- Anesthesia Masks and Endoscopy Masks
- HMEF and Filters
- Gas Sampling Line
- Latex Breathing Bag: 3L, 2L, 1L, 0.5L
- Latex-Free Breathing Bag: 3L, 2L, 1L, 0.5L

Standard Anesthesia Circuit

- A lighter and more economical option.
- Elbow with built-in 4.3 luer port for gas sampling.
- Single Patient Use , conform to ISO-10993-1.
- Biocompatible & ISO conformance.

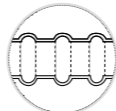
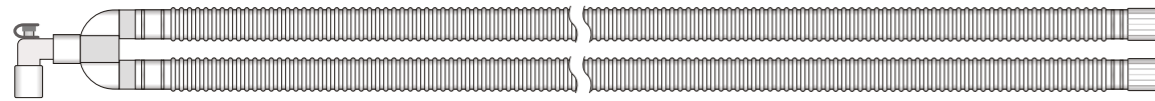

Corrugated

REF	Application	Elbow	Wye	Inhale	Exhale	QTY
AB0042	Adult	22/15 with Luer	22/15, 22M	120 cm, 22F	120 cm, 22F	30 pcs/carton
AB0289	Child	22/15 with Luer	22/15, 22M	150 cm, 15F	150 cm, 15F	15 pcs/carton

Dimensions:

- Breathing circuit: conform to ISO 5367
- Patient port: 22/15 mm conform to ISO 5356-1
- Gas sampling port: Luer, conform to ISO 594-1

Optional Accessories:

- Anesthesia Masks and Endoscopy Masks
- HMEF and Filters
- Gas Sampling Line
- Latex Breathing Bag: 3L, 2L, 1L, 0.5L
- Latex-Free Breathing Bag: 3L, 2L, 1L, 0.5L

Swivel Anesthesia Circuit

- Swivel Wye.
- A lighter and more economical option.
- Swivel wye with built-in 4.3 luer port for gas sampling.
- Single Patient Use , conform to ISO-10993-1.
- Biocompatible & ISO conformance.

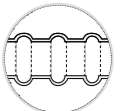
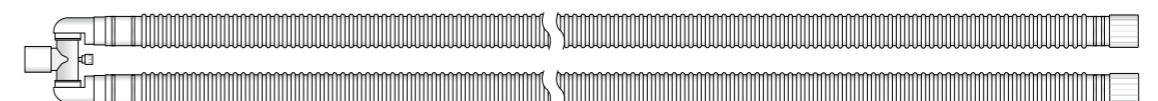

Corrugated

REF	Application	Swivel Wye	Inhale	Exhale	QTY
AB0185	Adult	22/15 with Luer	180 cm, 22F	180 cm, 22F	15 pcs/carton

Dimensions:

- Breathing circuit: conform to ISO 5367
- Patient port: 22/15 mm conform to ISO 5356-1
- Gas sampling port: Luer, conform to ISO 594-1

Optional Accessories:

- Anesthesia Masks and Endoscopy Masks
- HMEF and Filters
- Gas Sampling Line
- Latex Breathing Bag: 3L, 2L, 1L, 0.5L
- Latex-Free Breathing Bag: 3L, 2L, 1L, 0.5L

Theta Anesthesia Circuit

- Inspiratory and expiratory flow within a single tube, separated by a divider.
- A lighter and more economical option.
- Elbow with built-in 4.3 luer port for gas sampling.
- Collapsible exhale limb for more flexibility.
- Single Patient Use, conform to ISO-10993-1.
- Biocompatible & ISO conformance.

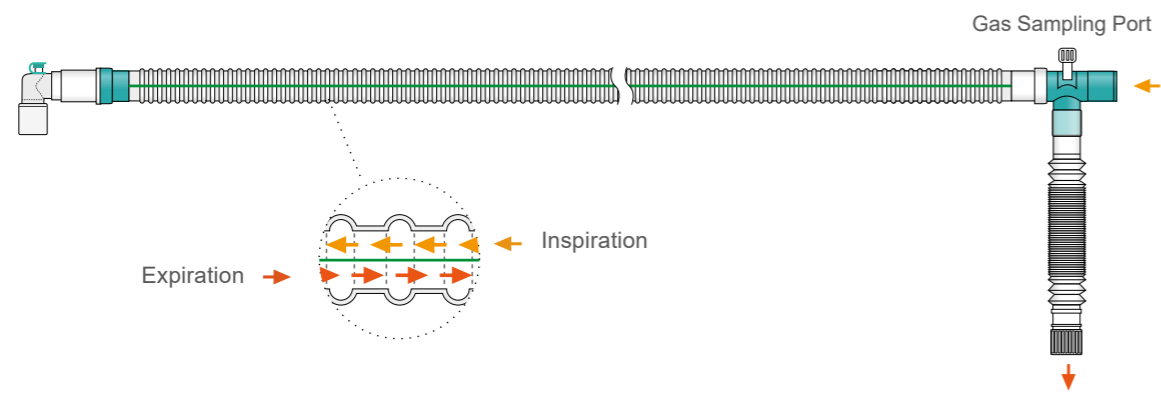

REF	Application	Elbow	Patient	Main Tube	Exhale	QTY
AB0057	Adult	22/15	22/15	180 cm, 22F	12-30 cm (Expandable)	20 pcs/carton
AB0260	Adult	22/15	22/15	150 cm, 22F	12-30 cm (Expandable)	20 pcs/carton

Dimensions:

- Breathing circuit: conform to ISO 5367
- Patient port: 22/15 mm conform to ISO 5356-1
- Gas sampling port: Luer, conform to ISO 594-1

Optional Accessories:

- Anesthesia Masks and Endoscopy Masks
- HMEF and Filters
- Gas Sampling Line
- Latex Breathing Bag: 3L, 2L, 1L, 0.5L
- Latex-Free Breathing Bag: 3L, 2L, 1L, 0.5L

Bain Circuit

- All-in-One Bain circuit with coaxial tube design. Smoothbore inspiratory limb within the expiratory limb.
- A lighter and more economical option.
- Elbow with built-in 4.3 luer port for gas sampling.
- Collapsible exhale limb for more flexibility.
- Single Patient Use, conform to ISO-10993-1.
- Biocompatible & ISO conformance.

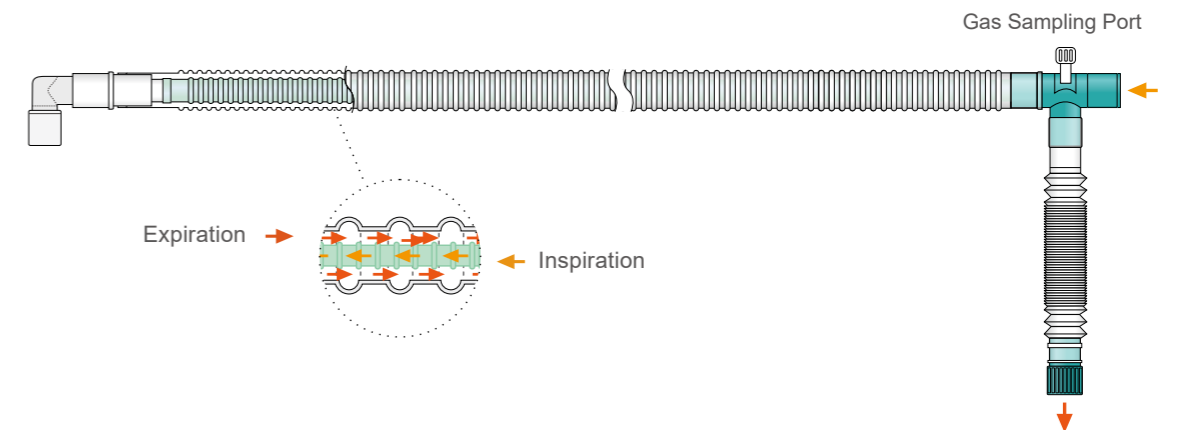

REF	Application	Elbow	Patient	Main Tube	Exhale	QTY
AB0229	Adult	22/15	22/15	120 cm, 22F	12-30 cm (Expandable)	20 pcs/carton
AB0230	Adult	22/15	22/15	180 cm, 22F	12-30 cm (Expandable)	20 pcs/carton

Dimensions:

- Breathing circuit: conform to ISO 5367
- Patient port: 22/15 mm conform to ISO 5356-1
- Gas sampling port: Luer, conform to ISO 594-1

Optional Accessories:

- Anesthesia Masks and Endoscopy Masks
- HMEF and Filters
- Gas Sampling Line
- Latex Breathing Bag: 3L, 2L, 1L, 0.5L
- Latex-Free Breathing Bag: 3L, 2L, 1L, 0.5L

Coaxial Anesthesia Circuit

- Coaxial Design corrugated inspiratory limb within the expiratory limb.
- A lighter and more economical option.
- Elbow with built-in 4.3 luer port for gas sampling.
- Collapsible Exhale limb for more flexibility.
- Single Patient Use , conform to ISO-10993-1.
- Biocompatible & ISO conformance.

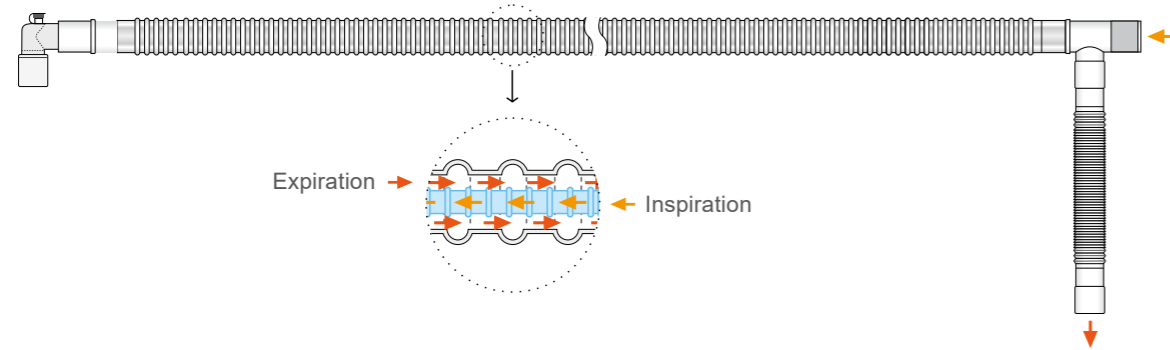

REF	Application	Elbow	Patient	Main Tube	Exhale	QTY
AB0178	Adult	22/15	22/15	100 cm, 22F	17-40 cm (Expandable)	15 pcs/carton
AB0179	Adult	22/15	22/15	150 cm, 22F	17-40 cm (Expandable)	15 pcs/carton
AB0299	Adult	22/15	22/15	180 cm, 22F	17-40 cm (Expandable)	15 pcs/carton

Dimensions:

- Breathing circuit: conform to ISO 5367
- Patient port: 22/15 mm conform to ISO 5356-1
- Gas sampling port: Luer, conform to ISO 594-1

Optional Accessories:

- Anesthesia Masks and Endoscopy Masks
- HMEF and Filters
- Gas Sampling Line
- Latex Breathing Bag: 3L, 2L, 1L, 0.5L
- Latex-Free Breathing Bag: 3L, 2L, 1L, 0.5L

Jackson Rees Anesthesia Circuit

- Tail-end control valve allows the adjustment of pressure levels within the system.
- Enable exhaled air to be collected and directed to a scavenging system.
- Lightweight and Disposable.
- Single Patient Use , conform to ISO-10993-1.
- Biocompatible & ISO conformance.

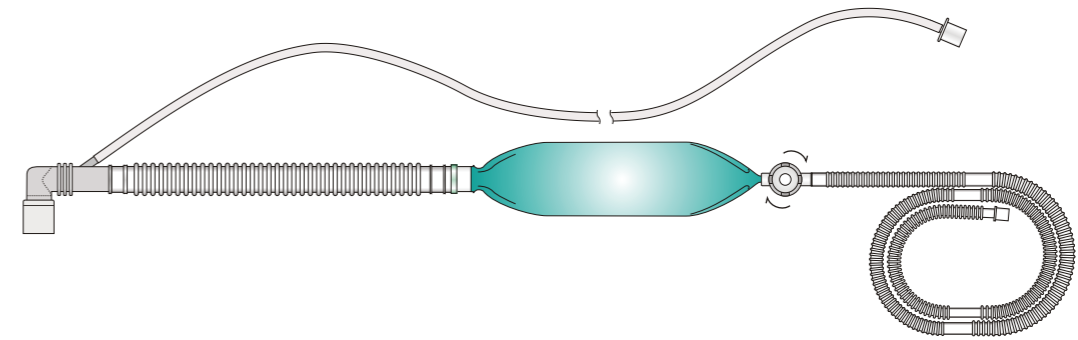

REF	Application	Patient	Flex tube	Supply tube	Exhale tube	Breathing Bag	QTY
AB0158	Neonate					0.5 L, Latex	15 pcs/carton
AB0166	Infant					1.0 L, Latex	15 pcs/carton
AB0167	Infant	22/15	25 cm, 22F	200 cm, 5F,	150 cm, 13F	1.0 L, Latex-free	15 pcs/carton
AB0169	Child	Elbow	Corrugated	15M Cuff	22/19 mm Cuff	2.0 L, Latex	15 pcs/carton
AB0175	Adult					3.0 L, Latex	15 pcs/carton
AB0176	Adult					3.0 L, Latex-free	15 pcs/carton

Dimensions:

- Patient port: 22/15 mm conform to ISO 5356-1
- Gas supply port: 15 mm OD, conform to ISO 5356-1

Optional Accessories:

- Anesthesia masks
- Latex Breathing Bag: 3L, 2L, 1L, 0.5L
- Latex-Free Breathing Bag: 3L, 2L, 1L, 0.5L



Oropharyngeal Airway



Guedel Airway Management Kit

- To maintain or open a patient's airway.
- Designed with reinforced bite block with a large flange that has a gentle curve to follow the contour of the tongue.

- AW0001** Guedel Airway 40 mm, Pink
- AW0046** Guedel Airway 50 mm, Blue
- AW0047** Guedel Airway 60 mm, Black
- AW0048** Guedel Airway 70 mm, White
- AW0005** Guedel Airway 80 mm, Green
- AW0006** Guedel Airway 90 mm, Yellow
- AW0049** Guedel Airway 100 mm, Red
- AW0002** Guedel Airway 110 mm, Orange
- AW0003** Guedel Airway 120 mm, Purple

Package: 200 pcs/carton



Berman Airway Management Kit

- Anatomical shape designed to follow the curvature of the tongue and oropharyngeal airway.
- Dual-side channel with holes minimize the risk of airway occlusion.
- Suction tube can be placed along the side channel of the Berman airway for insertion.

- AW0074** Bermen Airway 40 mm
- AW0050** Bermen Airway 50 mm
- AW0051** Bermen Airway 60 mm
- AW0052** Bermen Airway 70 mm
- AW0053** Bermen Airway 80 mm
- AW0007** Bermen Airway 90 mm
- AW0054** Bermen Airway 100 mm

Package: 200 pcs/carton





Face Mask



Sil-Flex™ Silicone Mask 134

- Bio-compatible and latex free ergonomic design with soft silicone material provides better seal, comfort and air circulation.
- Can be reprocessed for multiple use.



- AM0086** Sil-Flex Silicone Mask #5, Adult Large
- AM0024** Sil-Flex Silicone Mask #4, Adult
- AM0023** Sil-Flex Silicone Mask #3, Child Large
- AM0016** Sil-Flex Silicone Mask #2, Child
- AM0005** Sil-Flex Silicone Mask #1, Infant Large
- AM0004** Sil-Flex Silicone Mask #0, Infant

Package: 50 pcs/carton

Air-soft™ Aircushion Mask X

- A disposable mask for resuscitation, anesthesia and oxygen or aerosol delivery applications.
- Built-in check valve for air volume adjustments in the aircushion.
- Mask with the check valve is available in 7 sizes and each has color-coded allowing for size identification.

w/Valve



w/o Valve



REF	Color	Description	QTY
AM0026	○	Airsoft Mask, #0 w/Valve	50 pcs/carton
AM0027	●	Airsoft Mask, #1 w/Valve	50 pcs/carton
AM0028	●	Airsoft Mask, #2 w/Valve	50 pcs/carton
AM0029	●	Airsoft Mask, #3 w/Valve	50 pcs/carton
AM0030	●	Airsoft Mask, #4 w/Valve	50 pcs/carton
AM0031	●	Airsoft Mask, #5 w/Valve	50 pcs/carton
AM0032	●	Airsoft Mask, #6 w/Valve	20 pcs/carton
AM0025	○	Airsoft Mask, #0	50 pcs/carton
AM0092	●	Airsoft Mask, #1	50 pcs/carton
AM0093	●	Airsoft Mask, #2	50 pcs/carton
AM0094	●	Airsoft Mask, #3	50 pcs/carton
AM0095	●	Airsoft Mask, #4	50 pcs/carton
AM0096	●	Airsoft Mask, #5	50 pcs/carton

Endo Mask



A revolutionary design that enables simultaneous application of endoscopy during anesthesia or mechanical ventilation, the Aplus Endo Mask is specifically designed with a flexible port positioned in an ideal part of the mask to allow easier insertion of nasal or oral endoscope.

- AW0065** Endo Mask (Medium) with Head Strap
- AW0009** Endo Mask (Large) with Head Strap

Package: 20 pcs/carton

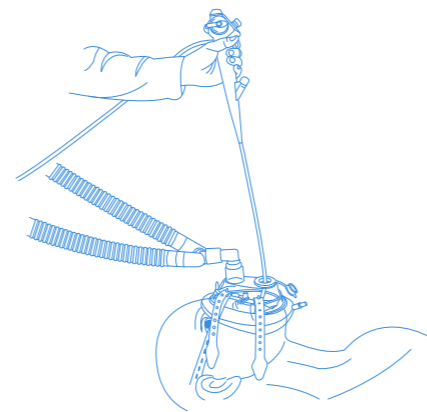

Heat and Moisture exchange filter (HMEF) & Filter



FILTER RANGES

BV Filter & HMEF

	REF	Filter Media	Port	Weight (g)	Dead Space (ml)	"Resistance (cmH ₂ O@LPM)"	Moisture output (mg/L)	BFE MPS: 2.9µm@30LPM	VFE MPS: 2.9µm@30LPM
Heated and moisture exchanger (HME)	AH0022	Paper media	-	2.5	33	0.2@5	31	-	-
	AH0039	Foam media	-	18	54.5	2.0@60	>30	-	-
	AH0040	Foam media	-	-	33	-	31	-	-
HMEF	AH0025	Paper Media	-	25	<50.1	1.53@30	>30	>99.99%	99.97%
	AH0026	Paper Media	Luer	25	<50.1	1.53@30	>30	>99.99%	99.97%
	AH0041	Electrostatic/ Foam	Luer	29	<35.00	2.30@60	31.6	>99.99%	>99.99%
Filter	AF0001	Electrostatic	-	22	<32.93	0.94@40	-	>99.99%	>99.99%
	AF0002	Paper Media	Luer	38	<34.80	4.37@60	-	>99.9999%	>99.9999%
	AF0003	-	-	-	<0.5	78@0.6	-	-	-
	AF0005	Electrostatic	Luer	17	<39.94	1.02@30	-	>99.99%	>99.99%
	AF0006	Electrostatic	Luer	-	-	-	-	-	-
	AF0007	Electrostatic	-	17	<37.68	0.86@30	-	>99.99%	>99.99%
	AF0008	Electrostatic	-	-	<48.5	0.71@30	-	>99.99%	>99.99%
	AF0009	Electrostatic	-	-	<32.8	0.66@30	-	>99.99%	>99.99%
	AF0011	Electrostatic	-	-	<99.37	0.77@40	-	>99.99%	>99.99%
	AF0012	-	-	-	<71	1.8@50	-	>99.99%	>99.99%
	AF0013	-	-	-	-	-	-	-	-
	AF0016	Electrostatic	-	-	<86.1	2.4@60	-	>99.99%	>99.99%
	AF0019	-	-	-	-	-	-	-	-
	AF0020	Electrostatic	Luer	23	<33.43	1.19@40	-	>99.99%	>99.99%

Heat and Moisture Exchanger (HME)

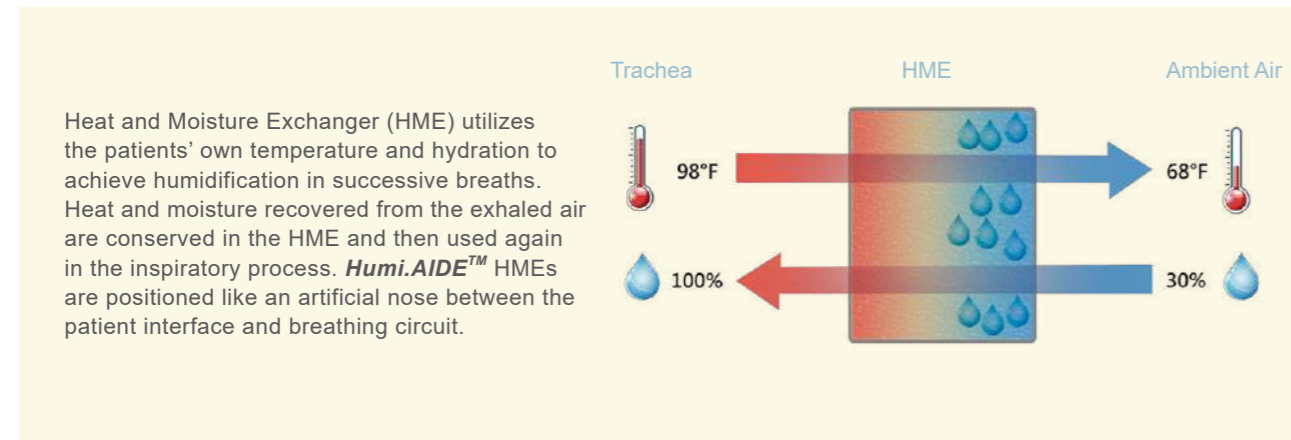

HME

Humi.AIDE™ HME is suitable for surgical ward, anesthesia, respiratory care, and intubated home-cared patients.

- Use standard 22/15 mm connection.
- Moisture Output: around 31 mg/L H₂O.
- Dead Space: 33 ml.

AH0040 HME, 22F/15M, 22/15 mm

Package: 50 pcs/carton

HME with Flex Tube

Humi.AIDE™ HME with Tube is suitable for surgical ward, anesthesia, respiratory care, and intubated home-cared patients.

- Extensive Flex Tube: Enable the flexibility in patient position management and reduce the chance of accidental disconnection.
- Use standard 22F, 15F connections.
- Moisture Output: around 30~35 mg/L H₂O.
- Dead Space: 54.5 ml.

AH0039 HME w/Tube, 22F, 15F

Package: 100 pcs/carton

Neonatal (nHME)

Humi.AIDE™ HME is suitable for surgical ward, anesthesia, respiratory care, and intubated home-cared patients.

- Use standard 22/15 mm connection.
- Moisture Output: around 31 mg/L H₂O.
- Dead Space: 33 ml.

AH0022 nHME, 15F, 15M

Package: 100 pcs/carton



Heat and Moisture Exchanger Filter (HMEF)

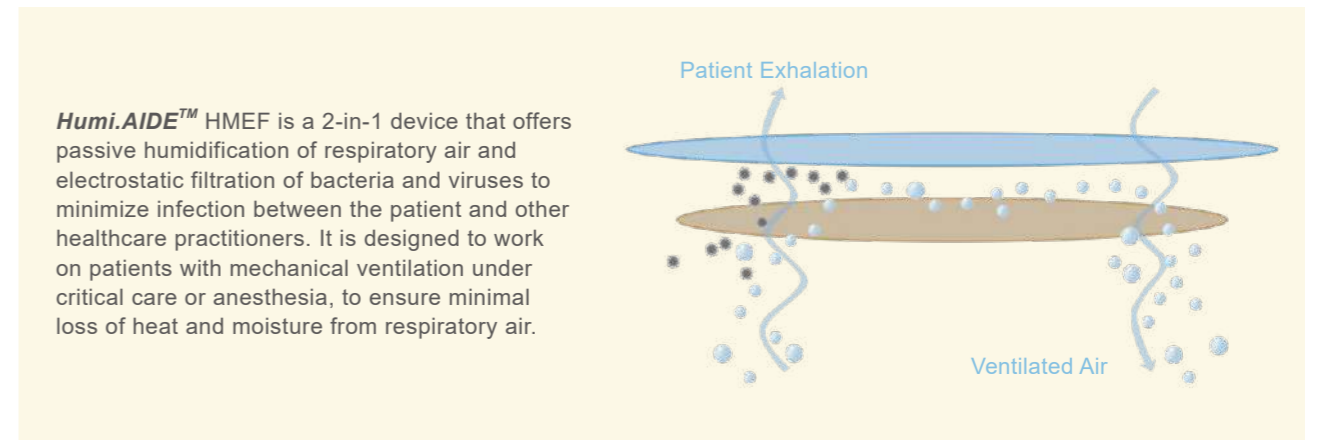

Foam Type HMEF

Humi.AIDE™ HMEF w/Luer is suitable for surgical ward, anesthesia, respiratory care, and intubated home-cared patients.

- Use standard 22/15 mm connection.
- Moisture output: around 31 mg/L H₂O.
- Dead Space: 33 ml.
- Filtration: Provide up to 99.99% of efficiency.
- Luer Port: For pressure monitoring and gas sampling.

AH0041 HMEF w/Luer, 22F/15M, 22/15 mm

Package: 50 pcs/carton

Humi.AIDE™ Paper Type HMEF (pHMEF)

Humi.AIDE™ Paper HMEF (pHMEF) is designed to be used in conjunction with ventilation circuits under critical care or anesthesia.

- Paper Media Ensure efficient retention of heat and moisture and filtration of bacteria and viruses.
- Use standard 22/15 mm connections.
- Dead Space: 50.1 ml.
- Bacterial/ Viral filtration: Provide up to 99.99% /99.97% of efficiency respectively.
- Optional 4.3F Luer Port: For pressure monitoring and gas sampling.

AH0025 HMEF, 22F/15M, 22/15 mm

AH0026 HMEF w/Luer, 22F/15M, 22/15 mm

Package: 50 pcs/carton



Heat and Moisture Exchanger Filter (Filter)

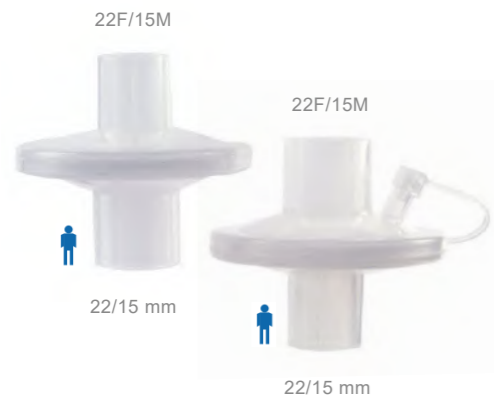

Bacterial Filter (Foam filtering medium)

- Equipped with 0.3 micron bacterial filter membrane for up to 99.99% of efficiency.
- Pressure resistance: less than 1cmH₂O/ 50lpm.
- Standard 22 mmID/15 mmOD and 22/15 mm connectors meet ISO Standard.
- Material: polypropylene.

- AF0001** Filter, 22F/15M, 22M/15F
- AF0019** Filter, 22F/15M, 22M/15F
- AF0020** Filter, 22F/15M, 22M/15Fw/Luer

Package: 150 pcs/box



HEPA Radial Pleated Filter (Paper filtering medium)

- Long term anesthesia/ventilation bacterial filtration up to 99.9999% of efficiency.
- Standard 22 mmID/15 mmOD connectors meet ISO Standard.

- AF0002** Filter, HEPA w/luer, 22F/15M, 22/15 mm

Package: 150 pcs/box



Pressure Line Filter

- Hydrophobic filter provides high efficiency to block water that may damage pressure sensor.
- Standard luer connections(male and female).
- Color code for directions.

- AF0003** Hydrophobic Filter, 7.6M w/Luer
- AF0013** Hydrophobic Filter, 4F, 4M

Package: 50 pcs/box

Heat and Moisture Exchanger Filter (Filter)



Viral / Bacterial Filter

High efficiency bacterial filter to minimize cross-contamination between patients, equipment and other healthcare practitioners.

REF	Description	Resistance to flow at 30L/min (cmH ₂ O)	Compressible Volume(ml)	Bacterial Filtration Efficiency	Viral Filtration Efficiency	Luer	QTY
AF0005	Filter 22F/15M w/Luer	0.950	39.93	99.999%	99.99%	●	50 pcs/carton
AF0007	Filter, 22F/15M, 22/15mm	0.825	37.68	99.999%	99.99%	N/A	50 pcs/carton
AF0008	Filter, 30F, 22/15mm	0.625	48.58	99.999%	99.99%	N/A	50 pcs/carton
AF0009	Filter, 30F, 30M	0.535	46.29	99.999%	99.99%	N/A	50 pcs/carton

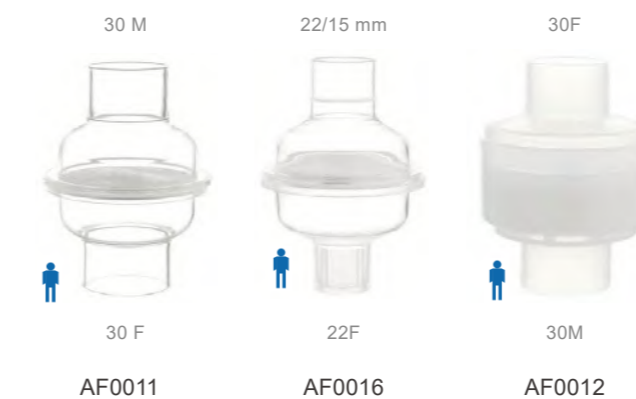

Electrostatic Bacterial Filter

High-performing Electrostatic Bacterial Filter not only protects patients from contaminating by bacterial and viruses but also avoids the equipment being moisturized. The use of breathing filters in the anesthesia and ICU, as well as other settings, helps to address cross-infection, a concern commonly associated with mechanical ventilation.

- Bacterial Filtration Efficiency : 99.99%.
- Viral Filtration Efficiency : 99.99%.

REF	Description	Resistance (cmH ₂ O@LPM)	Compressible Volume(ml)	Bacterial Filtration Efficiency	Viral Filtration Efficiency	Luer	QTY
AF0011	Filter, 30F, 30M	0.77@40	<99.37	99.99%	99.99%	N/A	150 pcs/carton
AF0012	Exhalometer filter, 30F, 30M	1.8@50	<71	99.99%	99.99%	N/A	50 pcs/carton
AF0016	Filter, 22F, 22/15mm	2.4@60	<86.1	99.99%	99.99%	N/A	150 pcs/carton

Tracheal Heat and Moisture Exchanger (tHME)

The **Humi.AIDE™** Tracheal Heat and Moisture Exchanger (tHME) provides passive humidification for spontaneously breathing tracheostomy patients. The tHME is designed with a standard 15mm fitting for attachment to the patient's tracheotomy tube. The tHME has a compact and lightweight design that reduces pressure at the sensitive trachea site and helps provide optimum patient ventilation.



Light Paper Media

Original paper media provides efficient heat and moisture exchange to patient.



Optional Adjustable Breathing Resistance (ABR) Valve

An optional Adjustable Breathing Resistance (ABR) Valve helps to reduce patient work of breathing and provides users greater comfort and flexibility.



Optional Oxygen Tubing

Designed with oxygen tubing connection for supplemental oxygen.



Tracheal Heat and Moisture Exchanger (tHME)

	Standard	Oxygen Tube	ABR Valve
--	----------	-------------	-----------



REF	AH0023	AH0071	AH0024
Description	tHME, 15F	tHME w/Tubing	tHME, 15F w/Knob
Feature	Standard HME, ready for use design	Equipped with total length of 170 cm oxygen tubing	Designed Adjustable Breathing Resistance (ABR) Valve
Dead Space	11.7 ml	12.0 ml	11.7 ml
Tidal Volume	> 50 ml	> 50 ml	> 50 ml
Connectors	15F	15F	15F
Resistance	0.48 cmH ₂ O @ 60 LPM	0.48 cmH ₂ O @ 60 LPM	0.48 cmH ₂ O @ 60 LPM
Moisture Output	24.0 mg H ₂ O @ VT = 500 ml	24.0 mg H ₂ O @ VT = 500 ml	24.0 mg H ₂ O @ VT = 500 ml
QTY	50 pcs/carton	50 pcs/carton	50 pcs/carton

Inspired Oxygen Concentration vs Flow Rate

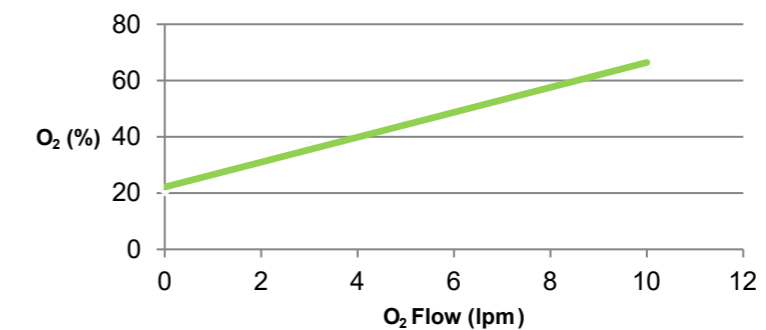

Test Conditions: Tidal volume 0.6L, 12 breath/min



Breathing Bag



Silicone Breathing Bag 134



- High-performance silicone breathing bag for multiple reprocessing.
- Feature a special cuff design and higher bag compliance.
- Tail-end hook for hanging to air-dry.
- Standard 22F connector.

- AB0109** Silicone Breathing Bag 3L
- AB0010** Silicone Breathing Bag 2L
- AB0108** Silicone Breathing Bag 1L
- AB0107** Silicone Breathing Bag 0.5L

Package: 50 pcs/carton

Latex-Free Breathing Bag X



- Single patient use breathing bag.
- Latex-free to mitigate the risk of latex allergy.
- Lower resistance and standard 22F connector with more rigid cuff.

- AB0122** Latex-Free Breathing Bag 3L
- AB0121** Latex-Free Breathing Bag 2L
- AB0120** Latex-Free Breathing Bag 1L
- AB0119** Latex-Free Breathing Bag 0.5L

Package: 50 pcs/carton

Latex Breathing Bag X



- Single patient use breathing bag.
- Lower resistance and standard 22F connector with more rigid cuff.

- AB0106** Latex Breathing Bag 3L
- AB0105** Latex Breathing Bag 2L
- AB0104** Latex Breathing Bag 1L
- AB0103** Latex Breathing Bag 0.5L

Package: 50 pcs/carton



Accessories



Tail-End Control Valve



Designed to adjust or release air or gas for breathing bag in Jackson Rees circuit or hyperinflation system.

AB0123 Durable Tail-End Control Valves

Package: 50 pkgs/box, 12 box/carton

ADU Connector



A disposable Tee-Piece can be used with anesthesia circuits or other ventilation equipment. It has 6M angled port for gas supply or pressure monitoring. ADU connector is specifically designed for GE anesthesia machines.

Note: ADU is designed for GE anesthesia machine only. (ADU-Anesthesia delivery unit)

AB0003 Disposable ADU Connector

Package: 100 pcs/pkg, 10 pckgs/ctn

Washington T-Piece



A disposable Washing T-Piece can be used with anesthesia circuits or other ventilation equipment. It has 6M angled port for gas supply or pressure monitoring. Washington T-Piece only fits for Jackson Rees circuit.

Note: Washington T is design for Jackson Rees circuit use.

AC0037 Washington T-Piece

Package: 100 pcs/pkg, 5 pkgs/ctn

Gas Sampling Line



Different types of tubes for delivering or monitoring airflow or CO₂.

- AB0005** Gas Sampling Line, 300 cm, 4M,4M
- AB0060** Gas Sampling Line, 300 cm, 4F, 4M
- AB0061** Gas Sampling Line, 50 cm, 4M, 4M
- AB0062** Gas Sampling Line, 300 cm, 4F, 4F
- AB0064** Gas Sampling Line, 180 cm, 4M, 4M

Package: 50 pcs/carton

ERGO Fixtures



Ergonomic clamps for pole, table and rail to secure devices in place. Dual holder model is available for pole clamp.

REF	Description	QTY
AB0152	Ckt Hanger, Stainless Steel, Clamp Type	6 pcs/carton
AB0011	Ckt Hanger, Stainless Steel, Pole Type	1 pcs/carton
AB0222	ISO Pole Clamp, Single	10 pcs/carton
AB0223	ISO Pole Clamp, Dual, Aluminum	10 pcs/carton
AB0224	ISO Table Mount Clamp, Aluminum	10 pcs/carton
AB0225	ISO Rail Mount Clamp	10 pcs/carton
AB0226	ISO Wall Mount Cradle	15 pcs/carton
AB0008	TC-1 Hose Clip, 15F w/3 clips	100 pcs/package, 20 pkgs/box
AB0009	TC-2 Hose Clip, 22F w/5 clips	100 pcs/package, 20 pkgs/box
AB0029	TC-4 Hose Clip, 22F w/2 clips	100 pcs/package, 20 pkgs/box
AB0030	TC-2 Hose Clip, 22F w/5 clips	100 pcs/package, 20 pkgs/box

Types of Breathing Circuit Tubing



Tube Design

- ◀ **Smoothbore Tubing**
 - Reduces air turbulence.
 - Low water retention and improved drainage.
- ◀ **Corrugated Tubing**
 - Provides an economical solution for ventilation circuits.
 - Material: EVA. Lightweight.
- ◀ **Collapsible Tubing**
 - Economical solution with lighter weight. Superior flexibility with adjustable length to suit different needs.
 - Reduces transport cost and required storage space.

Materials and Cleaning Instructions

Users or operators should fully understand the functions of each products and the following symbols before use:

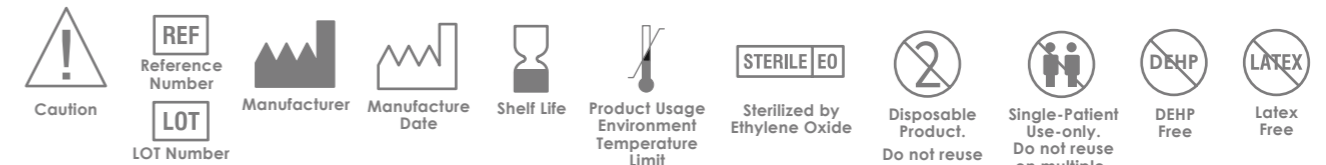

Common Materials and Sterilization Method

Material	Autoclavable	Chemical and Pasteurization	Ethylene Oxide Sterilization
PVC	No	No	No
Acrylic	No	No	No
K-Resin	No	No	No
ABS	No	No	Yes
Polyethylene(PE)	No	Yes	No
Polypropylene(PP)	No	Yes	No
Hytre	Up to 121°C	Mild Only	Yes
Polycarbonate(PC)	Up to 121°C	No	Yes
Polysulfone(PSF)	Up to 134°C	Yes	Yes
Silicone Rubber	Up to 134°C	Yes	Yes

※Note:
PSF and Silicone Rubber are autoclavable up to 134°C (at least 50 cycles).
Hytre and Polycarbonate are autoclavable up to 121°C (at least 20 cycles).

⚠ Disposable and Single-patient use products are designed to reduce the risk of cross-infection and therefore have strict prohibitions on re-processing and reusing on multiple patients.

When reusing durable products, please exercise strict adherence to validated institution policy and procedure, as well as the information available on disinfection or sterilization processes. Clean or disinfect when:

1. Any product part has been used
2. Any product part is contaminated
3. Any product part has been in use for more than 24 hours on a single-patient

Manufacturer's suggested procedure for disinfection:

The following instruction is a general guide. Please refer to individual organization's operating instructions on cleaning and disinfecting products:

- a. High Temperature Pressure Disinfection:
Products should be disinfected at 134°C for 5 minutes (eg. for materials such as polysulfone and silicone). For hytre and polycarbonate products, the temperature should not exceed 121°C and should not be processed for longer than 15 minutes.
- b. Chemical Disinfection:
Products should be soaked under warm water with mild detergents. Wash and rinse thoroughly to remove any residual material and store in a cool dry place to allow it to air dry.
- c. Ethylene Oxide Disinfection:
Follow the instruction for use for Ethylene Oxide disinfection devices.

Date / /

20 horizontal grey bars for text entry.

Date / /

15 horizontal grey bars for text entry.



AP2 UG (haftungsbeschränkt)
Erich-Ollenhauer-Str.12
51377 Leverkusen
Handelsregister: HRB 111772 Registergericht: Amtsgericht Köln
Vertreten durch: Paul Stamirski, Anton Zirnow
Telefon: +49 (0) 214 690 58 414
Email: info@ap2.tech