

# Neonatal Care Solution

---

Small Steps For Big Journey



# CONTENTS

06

nBubble CPAP System

15

Resuscitation

25

Breathing Circuit System

33

Oxygen Support

35

Test Lung

37

Others

40

Product Index

42

Symbols and Cleaning Instructions



# Neonatal Care Solution

nBubble CPAP system	07
Bubble PAP Valve	08
Pressure Limiting System Valve	09
nBubble CPAP Cannula Kit	10
nBubble CPAP Cannula Circuit Kit	11
Single Heated Wire Bubble CPAP Circuit	12
Dual Heated Wire Bubble CPAP Circuit	12
nBubble CPAP Prong	13
nBubble CPAP Prong Gauge	13
nBonnet	14
Dispo-bag/ R6/ R7/ MR100/ MR100 Plus/ nBag	16-21
Hyperinflation System	22
nAPV Circuit	23
nMask	24
Breathing Circuit System	26
Dual Limb Heated Wire Circuit	27
Single Limb Heated Wire Circuit	28-29
Connector Kit	30
Auto Feeding Chamber	31
Heated Humidifier (H5D and H5A)	32
Oxi.Hood	34
nTest Lung	36
Pole Clamp	38
Manual Percussor	38
GiO™ Manometer	39

## Babi.Plus®

Over the past decades, increasing in premature babies has become the challenging issue across the globe. Unlike the healthy newborns, premature babies may have more health problems, which include brain, heart, eyes, and respiratory issues. Because of having the premature lungs, most premature babies have breathing difficulties to survive.

The invention of Babi.Plus was backup by a team of experience physicians, engineers, and respiratory therapists work effectively , to offer a comprehensive range of medical care solutions for neonates. We trust these innovative solutions could offer a superior option for healthcare professions in delivering medical care and achieving better outcomes .

We care for the most fragile lungs.





## nBubble CPAP System



Bubble continuous positive airway pressure (CPAP) is a safe and effective respiratory support to neonates with respiratory distress syndrome (RDS) as an alternative to ventilator CPAP. The early use of Bubble CPAP reduces intubation days on mechanical ventilation, postnatal steroids use and increases postnatal weight gain with no increased complications.<sup>[1]</sup>

**Babi.Plus®** Bubble CPAP System provides comprehensive designs specially for premature infants, completing with Bubble CPAP generator, pressure limited safety valve, full ranges of nasal CPAP interfaces, Bubble CPAP heated wire circuit, and pressure monitoring system.

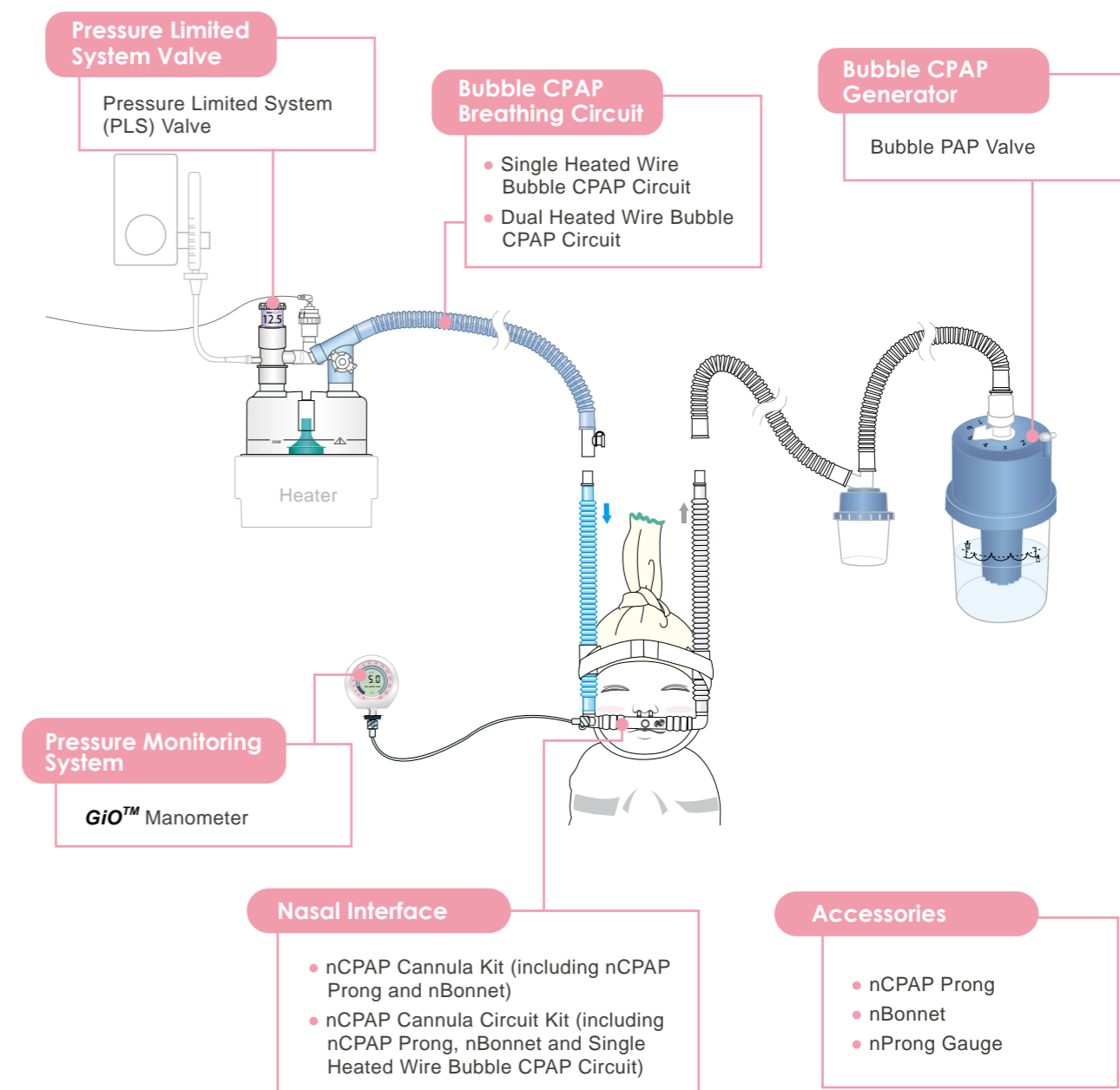

Reference[1] Narendran V, Donovan EF, Hoath SB, Akinbi HT, Steichen JJ, Jobe AH. Early bubble CPAP and outcomes in ELBW preterm infants. J Perinatol 2003;23:195-9

## Bubble PAP Valve

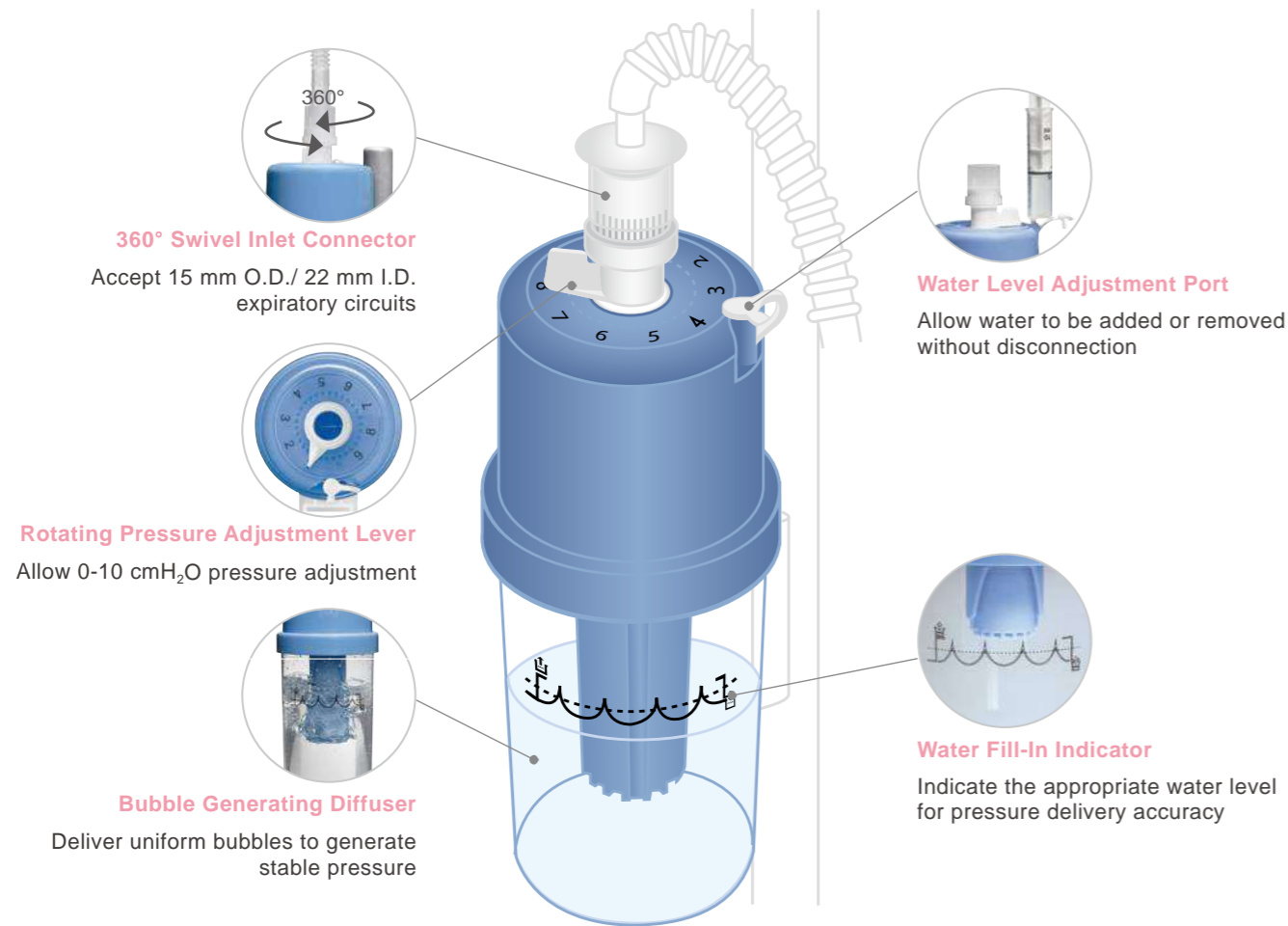

**Babi.Plus®** Bubble PAP Valve provides a continuous positive airway pressure to pre-terms, terms and infants weighing less than 10 kg for spontaneously breathing.

Bubble PAP Valve is adjustable from 0 to 10 cmH<sub>2</sub>O for gas flow 1-12 liters per minute with accuracy of ± 1 cmH<sub>2</sub>O.



Note: Bubble PAP Valve set does not come with a Pole Clamp. For Pole Clamp information, please find page 38.

REF	Description	QTY
AN0018	Bubble PAP Valve	12 pcs/box

## Pressure Limiting System Valve

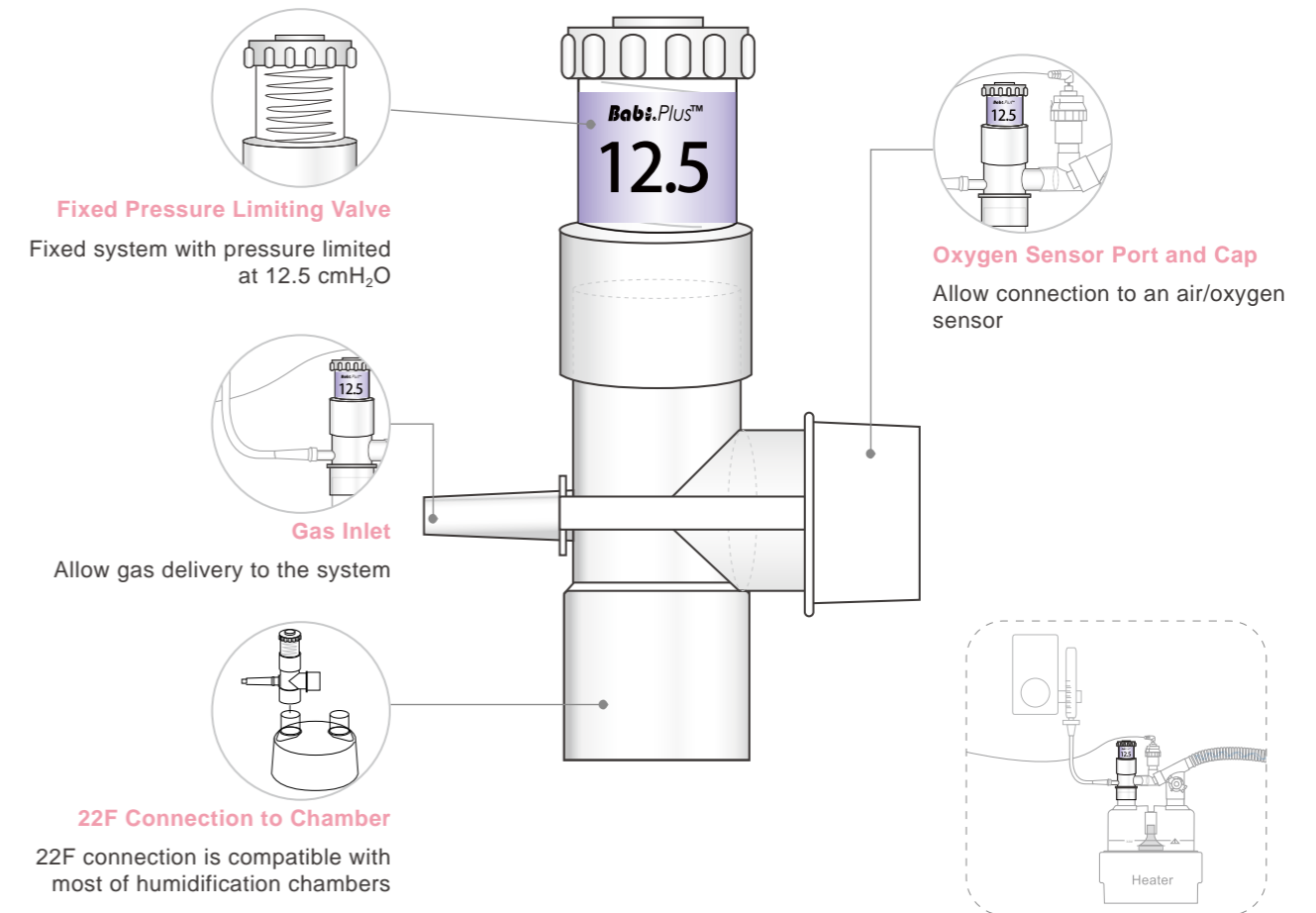

**Babi.Plus®** Pressure Limiting System (PLS) Valve is a safe guard to the pressure level in the circuit or bubble CPAP system. The fixed pressure limiting valve releases pressure when it is exceeding the preset level for patient's safety. PLS Valve is intended for use on pre-terms, terms and infants less than 10 Kg during continuous gas flow therapy up to 12 liters per minute. Each valve comes with a pressure-relief valve, a gas supply line and a capped oxygen sensor port.



REF	Description	QTY
AN0099	PLS Valve, 12.5 cmH <sub>2</sub> O, 22F	12 pcs/box
AN0019	PLS Valve, 10 cmH <sub>2</sub> O, 22F	12 pcs/box

## nBubble CPAP Cannula Kit

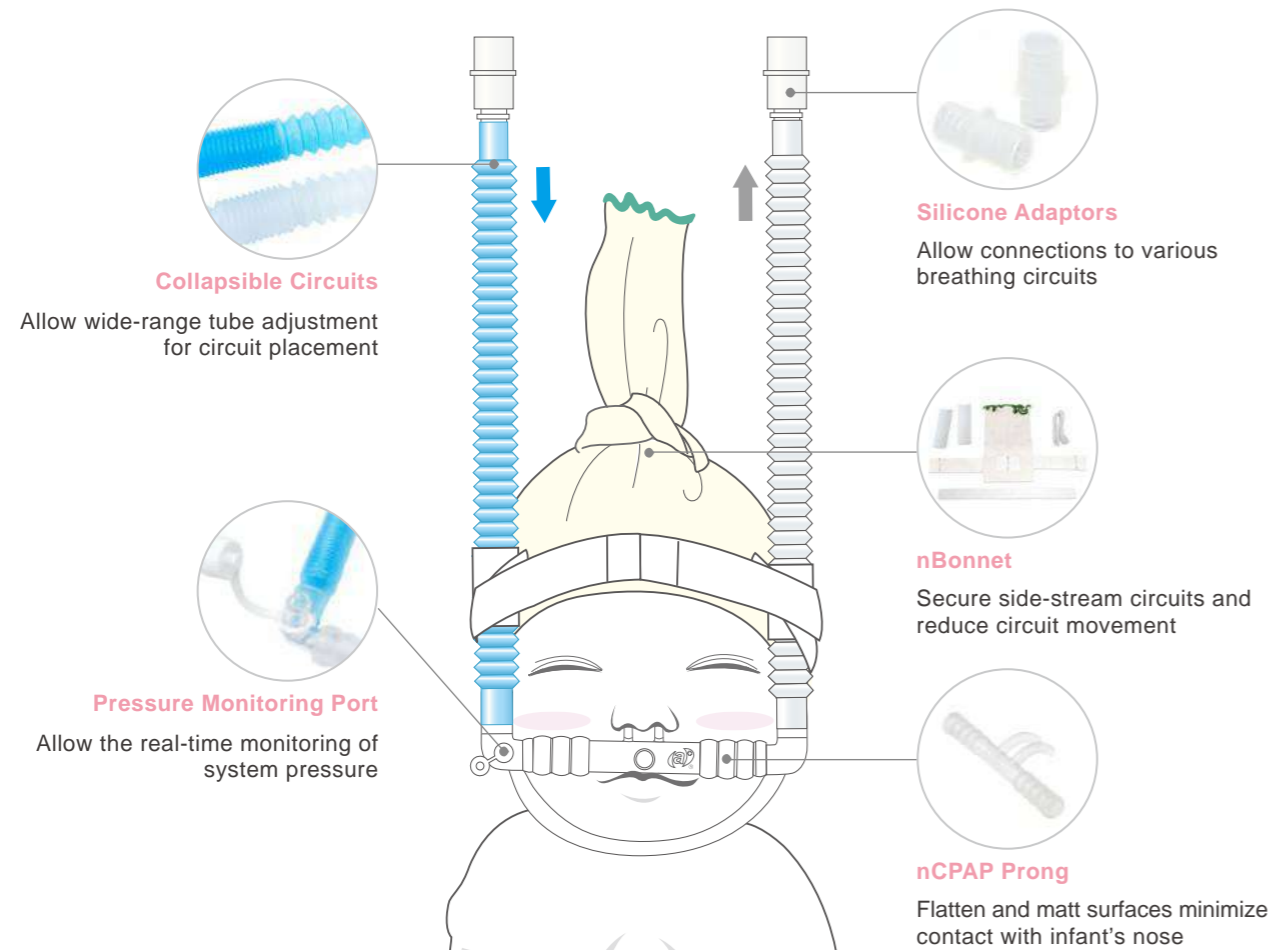

**Babi.Plus®** nBubble CPAP Cannula Kit can provide an effective way of gas delivery, and is uniquely designed to provide stability and safety during treatment. Each kit includes a silicone prong, a nBonnet, two 20 cm collapsible color-coded circuits (blue for inhale and transparent for exhale) and two silicone adaptors.



REF	Description	Prong Size	nBonnet Size	QTY
AN0020	nCPAP Cannula Kit, #0 w/ nBonnet Kit, #1	0	1	20 pcs/carton
AN0021	nCPAP Cannula Kit, #1 w/ nBonnet Kit, #1	1	1	20 pcs/carton
AN0022	nCPAP Cannula Kit, #2 w/ nBonnet Kit, #2	2	2	20 pcs/carton
AN0023	nCPAP Cannula Kit, #3 w/ nBonnet Kit, #2	3	2	20 pcs/carton
AN0024	nCPAP Cannula Kit, #4 w/ nBonnet Kit, #3	4	3	20 pcs/carton
AN0025	nCPAP Cannula Kit, #5 w/ nBonnet Kit, #3	5	3	20 pcs/carton
AN0026	nCPAP Cannula Kit, #6 w/ nBonnet Kit, #4	6	4	20 pcs/carton
AN0027	nCPAP Cannula Kit, #7 w/ nBonnet Kit, #4	7	4	20 pcs/carton

## nBubble CPAP Cannula Circuit Kit

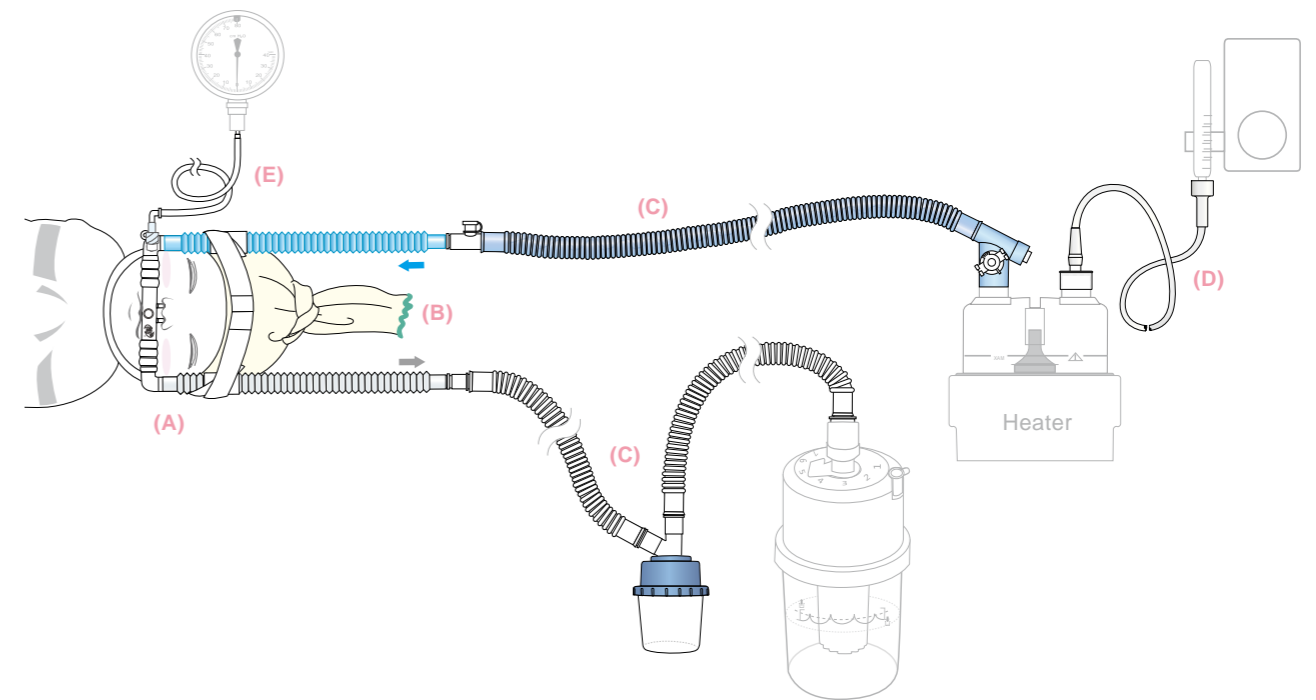

**Babi.Plus®** nBubble CPAP Cannula Circuit Kit offers a complete interfaces for **Babi.Plus®** and other various bubble CPAP systems.

- (A) Each kit includes a silicone prong ,  
Two collapsible color-coded circuits ,  
Two silicone adaptors ,
- (B) A nBonnet,
- (C) Single heated wire circuit ,
- (D) An oxygen tubing ,
- (E) A pressure monitoring line .

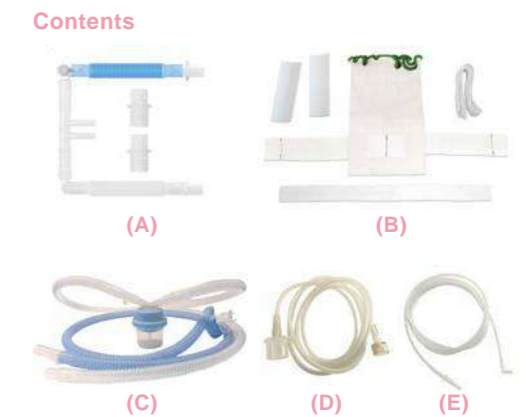

REF	Description	Prong Size	nBonnet Size	QTY
AN0030	nCPAP Cannula Circuit Kit, #0 w/Single Heated Wire Circuit	0	1	5 pcs/carton
AN0031	nCPAP Cannula Circuit Kit, #1 w/Single Heated Wire Circuit	1	1	5 pcs/carton
AN0032	nCPAP Cannula Circuit Kit, #2 w/Single Heated Wire Circuit	2	2	5 pcs/carton
AN0033	nCPAP Cannula Circuit Kit, #3 w/Single Heated Wire Circuit	3	2	5 pcs/carton
AN0034	nCPAP Cannula Circuit Kit, #4 w/Single Heated Wire Circuit	4	3	5 pcs/carton
AN0035	nCPAP Cannula Circuit Kit, #5 w/Single Heated Wire Circuit	5	3	5 pcs/carton
AN0036	nCPAP Cannula Circuit Kit, #6 w/Single Heated Wire Circuit	6	4	5 pcs/carton
AN0037	nCPAP Cannula Circuit Kit, #7 w/Single Heated Wire Circuit	7	4	5 pcs/carton

### Single Heated Wire Bubble CPAP Circuit

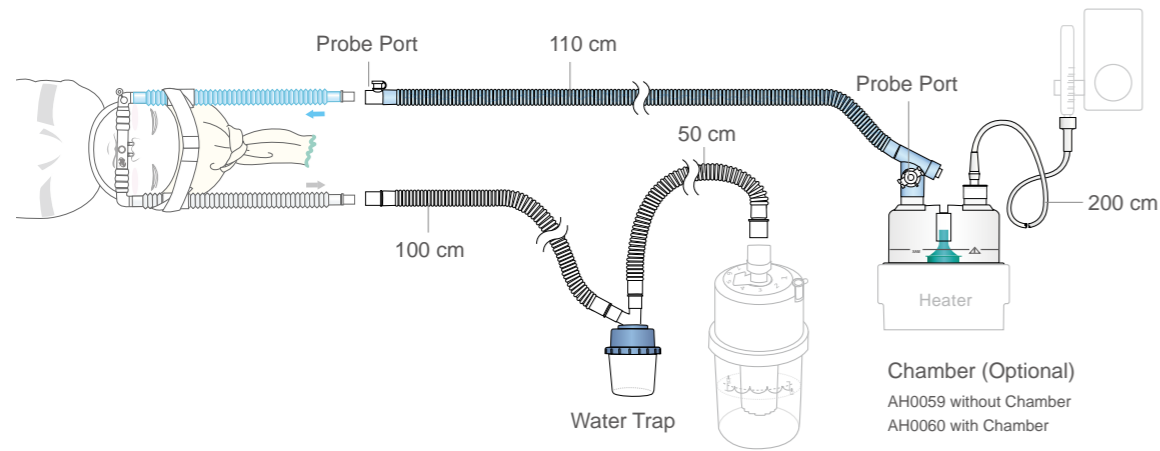

The Single Heated Wire Bubble CPAP Circuit contains heated inspiratory limb designed specifically for use with **Babi.Plus®** Bubble CPAP system.

REF	Description	QTY
AH0059	HW1 Circuit for Bubble CPAP	10 pcs/carton
AH0060	HW1 Circuit for Bubble CPAP w/chamber	10 pcs/carton

### Dual Heated Wire Bubble CPAP Circuit

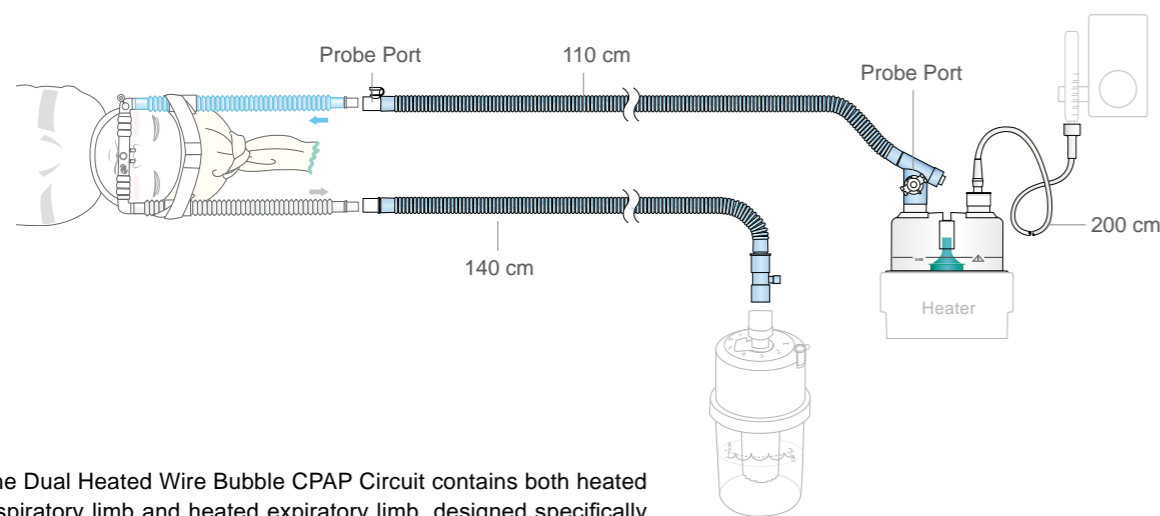

The Dual Heated Wire Bubble CPAP Circuit contains both heated inspiratory limb and heated expiratory limb, designed specifically for use with **Babi.Plus®** Bubble CPAP system.

REF	Description	QTY
AH0061	HW2 Circuit for Bubble CPAP w/chamber	10 pcs/carton

### nBubble CPAP Prong

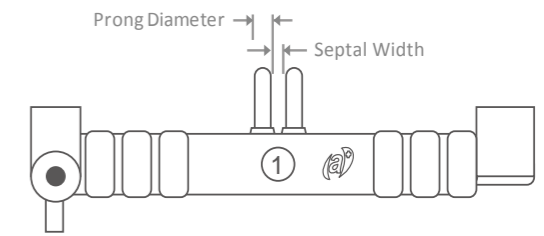

**Babi.Plus®** nBubble CPAP Prong is made of super soft silicone material to minimize skin irritation. Each nBubble CPAP Prong Kit includes a prong, two elbow connectors, one port elbow connector with a cap and two silicone adaptors.

REF	Description	Size	Septal Width (mm)	Prong Diameter (mm)	QTY
AN0010	nCPAP Prong, #0 w/ Pressure Port Elbow	#0	2.1	2.8	5 pcs/box
AN0011	nCPAP Prong, #1 w/ Pressure Port Elbow	#1	2.4	3.2	5 pcs/box
AN0012	nCPAP Prong, #2 w/ Pressure Port Elbow	#2	2.6	3.8	5 pcs/box
AN0013	nCPAP Prong, #3 w/ Pressure Port Elbow	#3	3.8	4.4	5 pcs/box
AN0014	nCPAP Prong, #4 w/ Pressure Port Elbow	#4	4.2	5.0	5 pcs/box
AN0015	nCPAP Prong, #5 w/ Pressure Port Elbow	#5	5.0	5.0	5 pcs/box
AN0016	nCPAP Prong, #6 w/ Pressure Port Elbow	#6	5.6	5.5	5 pcs/box
AN0017	nCPAP Prong, #7 w/ Pressure Port Elbow	#7	6.8	6.0	5 pcs/box

### nBubble CPAP Prong Gauge



**Babi.Plus®** nProng Gauge is a prong size measuring devices made of soft silicone material to minimize skin irritation. This ergonomic gauge assists clinicians with the selection of the appropriate size of nBubble CPAP Prong, and is also used as a gadget to gently dilate the nares.

AN0001 nProng Gauge

Package: 5 pcs/box

nBonnet 



**Babi.Plus®** nBonnet is designed to secure the side-stream CPAP delivery system. With elastic strap fixtures and open top design, nBonnet is able to reduce up & down movement and to accommodate more head shapes. Each nBonnet kit includes a bonnet, two adhesive hook style fasteners, one chin strap and one ribbon.



REF	Description	Color	Size	Head Circumference (cm)	Package
AN0005	nBonnet Kit, #1, XS, Green	●	#1	22~25	25 pcs/box
AN0006	nBonnet Kit, #2, S, Yellow	●	#2	25~28	25 pcs/box
AN0007	nBonnet Kit, #3, M, Red	●	#3	28~31	25 pcs/box
AN0008	nBonnet Kit, #4, L, Blue	●	#4	31~34.5	25 pcs/box
AN0009	nBonnet Kit, #5, XL, Black	●	#5	34.5~38	25 pcs/box



Resuscitation





## Dispo-Bag™ Manual Resuscitator



**Monitoring Port**  
Allow attachment to pressure or CO<sub>2</sub> monitoring system



**40 cmH<sub>2</sub>O Safety Valve**  
Release excessive pressure at fixed level



**30 mm O.D. Exhale Port**  
Connect to diverter cap or PEEP valve



**High transparency bag**  
Slip-free texture and arrow-shape bag

The **Dispo-Bag™** is a disposable, single patient use system for manual ventilation equipped with transparent medical grade PC, PVC materials for ergonomic, lightweight and visual feedback during resuscitation.

The premium medical grade PVC bag provides an economic design, offering fast rebound and less operational force to reduce operator fatigue.

REF	Description	Mask Size	Pop-Off (cmH <sub>2</sub> O)	Bag capacity (ml)	Reservoir Bag (ml)	Oxygen Tube (length:2m)	QTY
AR0079	DispoBag, Infant w/Pop-Off, Mask	#0	40	280	500	●	12 pcs/carton
AR0080	DispoBag, Infant w/Pop-Off, Reservoir	N/A	40	280	500	●	12 pcs/carton

## Rescu-6™ Manual Resuscitator

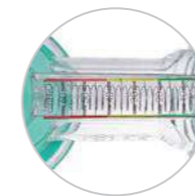

**Built-in airway pressure gauge**  
For monitoring airway and lung pressure



**40 cmH<sub>2</sub>O Safety Valve**  
Release excessive pressure at fixed level



**CO<sub>2</sub> measuring port**  
For patient air circulation ratio measurement



**Resuscitator bag**  
Non-PVC material and fast rebound

**Rescu-6™** is a disposable manual resuscitator with economic model, a feature built-in pressure manometer and an unique pop off valve with a cap for monitoring airway pressure and avoiding pulmonary injuries due to excessive pressure.

An unique Non-PVC bag gives highly responsive with minimal mechanical resistance to provide optimum stroke volume with perfect recoil.

REF	Description	Mask Size	Pop-Off (cmH <sub>2</sub> O)	Bag capacity (ml)	Reservoir Bag (ml)	Oxygen Tube (length:2m)	QTY
AR0027	R6 Resuscitator, Infant w/ Mask, #1	#1	40	280	500	●	12 pcs/carton
AR0028	R6 Resuscitator, Infant w/ Mask	N/A	40	280	500	●	12 pcs/carton

## Rescu-7™ Manual Resuscitator



**Diverter**

Can attach bacterial filter or PEEP



**40 cmH<sub>2</sub>O Safety Valve**

Release excessive pressure at fixed level



**Soft silicone resuscitator bag**

Can rebound swiftly



**All-in-one intake valve**

Reduce assembly time

**Rescu-7™** is a manual resuscitator which accompanies with a unique air bag which has high responsiveness and minimal mechanical resistance. It offers portability and cost-effective with perfect recoil.

REF	Description	Mask Size	Pop-Off (cmH <sub>2</sub> O)	Bag capacity (ml)	Reservoir Bag (ml)	Oxygen Tube (length:2m)	QTY
AR0070	R7 Resuscitator, Infant w/ Mask	#0	40	280	600	●	12 box/carton

## MR-100™ Manual Resuscitator



**Diverter**

Can attach bacterial filter or PEEP valve



**40 cmH<sub>2</sub>O Safety Valve**

Release excessive pressure at fixed level



**Product ID**

On major components for traceability



**Soft silicone resuscitator bag**

Slip-free surface texture and fast self-inflating rate

**MR-100™** Manual Resuscitator is sub-series of **MR-100 Plus™** (280 ml infant, 550 ml child, 1600 ml adult), supplied with an independent reservoir valve. Accessories consisted with silicone parts and PSF connectors, which guaranteeing longer life spans even after numerous sterilization cycles to meet economic needs.

REF	Description	Mask Size	Pop-Off (cmH <sub>2</sub> O)	Bag capacity (ml)	Reservoir Bag (ml)	Oxygen Tube (length:2m)	QTY
AR0002	MR-100 Resuscitator set, Infant	#0	40	280	600 (PVC)	●	12 boxes/carton
AR0039	MR-100 Resuscitator, Infant	#1	40	280	600 (PVC)	N/A	12 boxes/carton
AR0113	MR-100 Resuscitator set, Infant	#1	40	280	500 (Silicone)	N/A	12 boxes/carton
AR0112	MR-100 Resuscitator, infant	N/A	40	280	N/A	N/A	12 boxes/carton

# MR-100 Plus™ Manual Resuscitator



**40 cmH<sub>2</sub>O Safety Valve**

Releases excessive pressure at fixed level



**High transparency silicone bag**

Rapid recoil for optimum ventilation



**All-in-one intake valve**

Reduce assembly time



**High transparency silicone reservoir bag**

Longer life span for sterilization

**MR-100 Plus™** are our most delicate reusable manual resuscitators (280 ml infant, 550 ml child, 1500 ml adult) that consist of semi-transparent silicone parts and PSF connectors, which provide visual check of the patients' conditions and longer life spans after numerous sterilization cycles.

REF	Description	Mask Size	Pop-Off (cmH <sub>2</sub> O)	Bag capacity (ml)	Reservoir Bag (ml)	Oxygen Tube (length:2m)	QTY
AR0046	MR-100 Plus Resuscitator Kit, Infant	#0, 1	40	280	500 (Silicone)	●	10 boxes/carton
AR0058	MR-100 Plus Resuscitator, Infant	#0	40	280	500 (Silicone)	●	12 boxes/carton
AR0062	MR-100 Plus Resuscitator, Infant	N/A	40	280	600 (PVC)	N/A	12 boxes/carton

# nBag

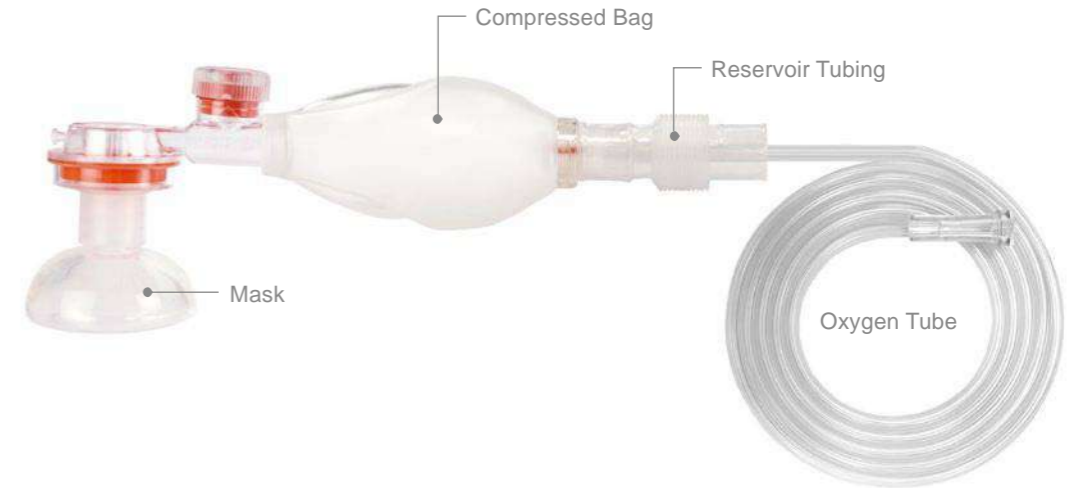

**Pressure Monitoring Port**

Allow prompt pressure measurement



**Pressure Safety Valve**

Allow limiting level adjustment of 25 cmH<sub>2</sub>O and 40 cmH<sub>2</sub>O



**Resuscitation Volume**

Precise volume prevents baby from volutrauma.

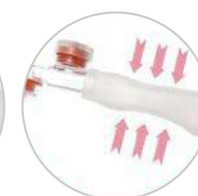

**Babi.Plus®** nBag minimizes patient's risk during operation through two pressure limiting levels, 25 cmH<sub>2</sub>O and 40 cmH<sub>2</sub>O. With the unique design, it's able to deliver two different smaller stroke volume, 20 ml or 50 ml. This safe pulmonary-assisted device, which is specially designed for premature and newborn infant up to 5 kg, is made of biocompatible, latex and phthalate-free silicone material.

REF	Description	QTY
AN0003	nBag Resuscitator	12 pcs/carton

## Hyperinflation System

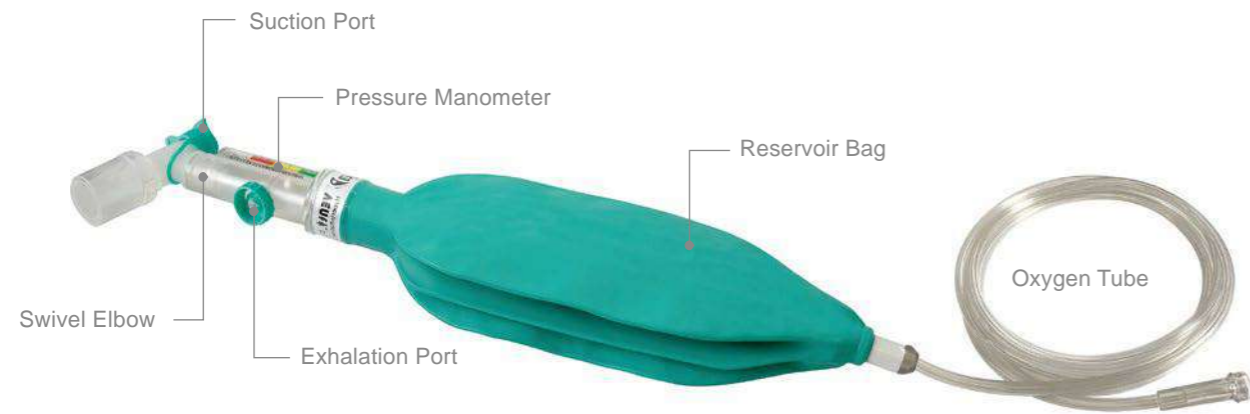

**Swivel elbow**  
Permit 360° positioning of the resuscitator in relation to the patient.



**Suction Port**  
Permit convenient suction without disengagement



**Pressure Manometer**  
Allow real-time pressure measurement



**Exhalation Port**  
Circular smooth adjustable exhalation port valve controls pressure level



**Hyperinflation Bag**  
Soft breathing bag with response of the lung compliance

Hyperinflation System includes a built-in pressure manometer which ranges 0-60 cmH<sub>2</sub>O with accuracy of 5 cmH<sub>2</sub>O. It continuously monitors the pressure that enters patient's lung, maximizing the survival rate.

REF	Description	QTY
AR0023	Venti.Plus Hyperinflation Kit, 0.25 L	20 pcs/carton
AR0024	Venti.Plus Hyperinflation Kit, 0.5 L	20 pcs/carton
AR0025	Venti.Plus Hyperinflation Kit, 0.5 L Mask	10 pcs/carton
AR0026	Venti.Plus Hyperinflation Kit, 1.0 L	20 pcs/carton

## nAPV Circuit

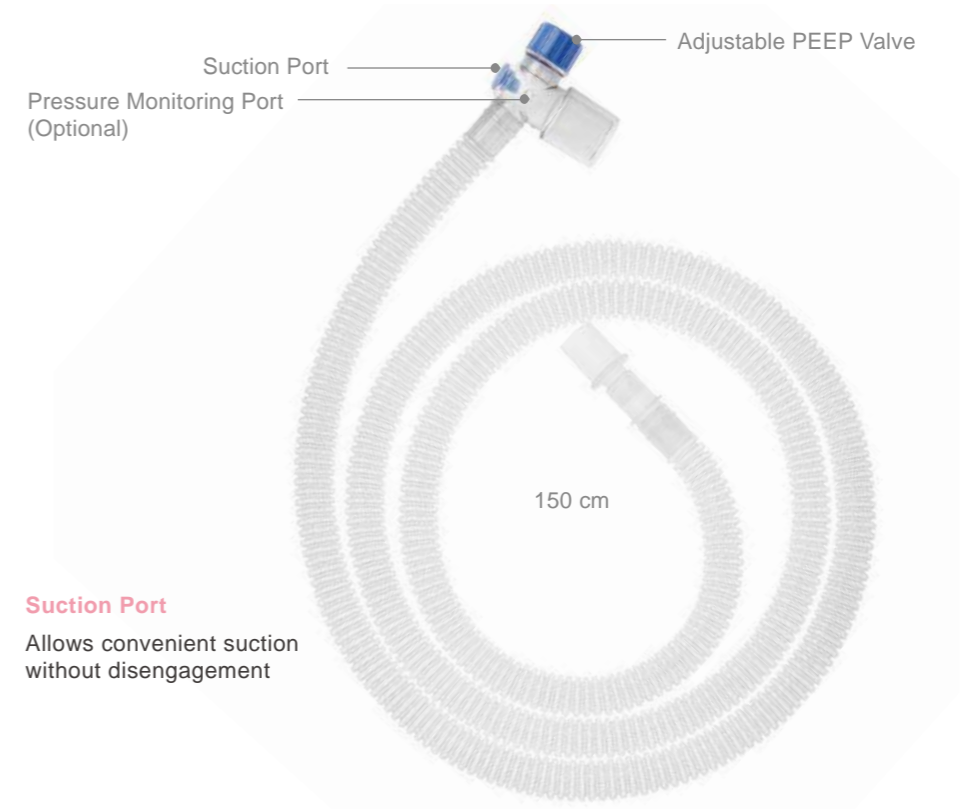

**Suction Port**  
Allows convenient suction without disengagement



**Adjustable PEEP Valve**  
PEEP level adjustment 2-25 cmH<sub>2</sub>O



**Pressure Monitoring Port (Optional)**  
Connect to pressure monitoring system for proximal airway pressure

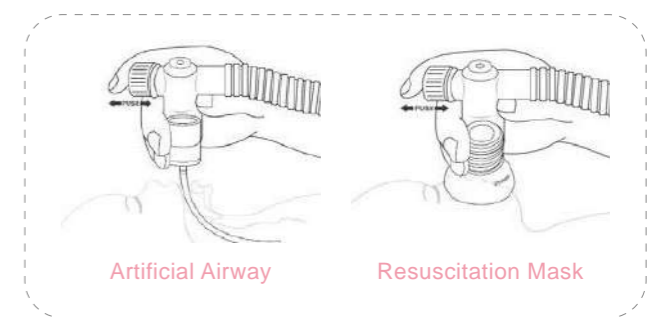

**Babi.Plus®** nAPV Circuit is a T-piece resuscitator for neonates weighing under 10 kg, which provides emergency pulmonary ventilation by means of mask or artificial airway through a gas power source. Operated under flow rate of 5-15 LPM, nAPV Circuit is available to deliver pressure up to 22 ± 2 cmH<sub>2</sub>O at 15 LPM and PEEP level adjustment 2-25 cmH<sub>2</sub>O.

REF	Description	QTY
AN0028	nAPV Circuit	10 pcs/box
AN0029	nAPV Circuit w/Pressure Port	10 pcs/box

## nMask

**15mm Connector**

With two level barb designed for easier attachment

**Sturdy and Flexible Shell**

Soft but steady silicone shell prevents from deformation

**Cushioned Rim**

Allow full cover around the mouth and nose, especially designed for premature



**Babi.Plus®** nMask is designed for use with resuscitators and T-piece resuscitation devices. With ergonomic construction, **Babi.Plus®** nMask seals around the mouth and nose but does not cover the eyes or overlap the chin. The **Babi.Plus®** nMask is designed to reduce air leakage and skin irritation. 6 sizes of nMasks are available for premature and neonatal patients.

REF	Description	QTY
AN0038	nMask, 25 mm	5 pcs/box
AN0039	nMask, 30 mm	5 pcs/box
AN0040	nMask, 35 mm	5 pcs/box
AN0041	nMask, 40 mm	5 pcs/box
AN0042	nMask, 45 mm	5 pcs/box
AN0043	nMask, 50 mm	5 pcs/box



## Breathing Circuit System



To support the airway function and ventilation of neonatal patients, a complete breathing circuit system includes an active humidification system that can deliver humidified and heated gas.

GaleMed provides a series of single and dual heated wire circuits. All heated limbs have a coiled heated wire structure to provide consistent heating airflow and limb walls to minimize possible rain-out.

The Y-shaped piece and the heated wire circuit can be applied to invasive or non-invasive mechanical ventilation, as shown in the figure below.

The connector kit with additional connectors can apply the circuit to different modern ventilation equipment.

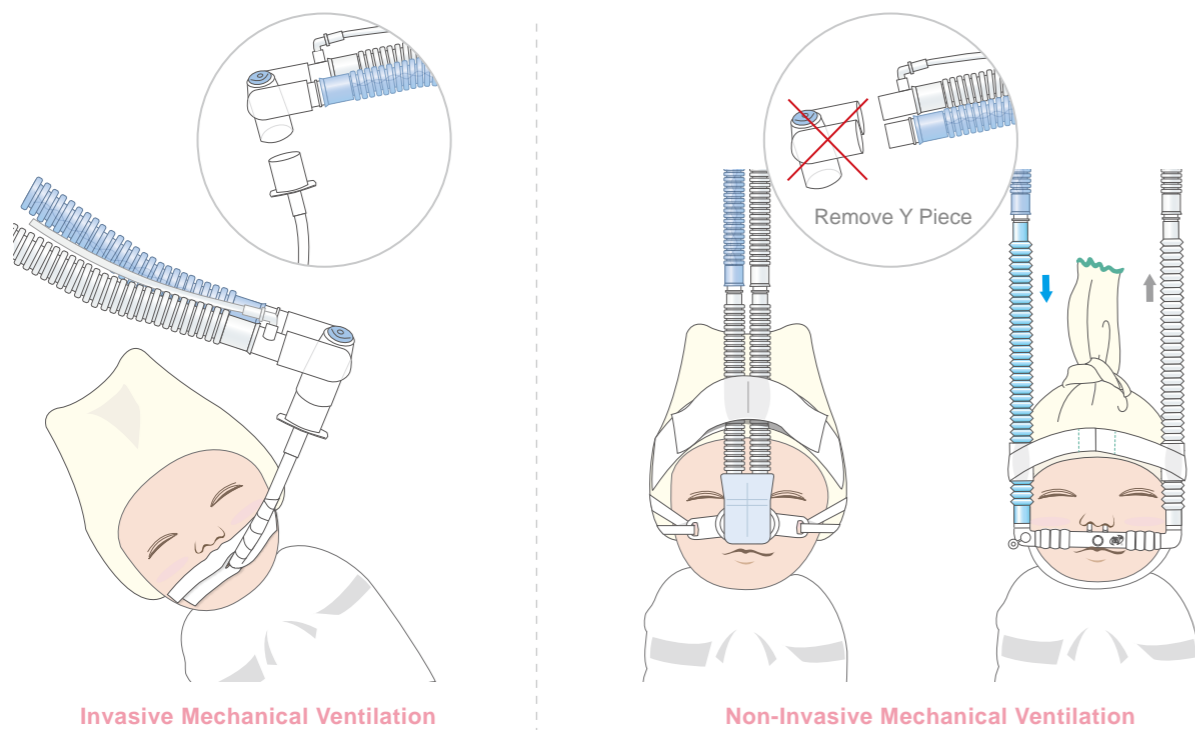
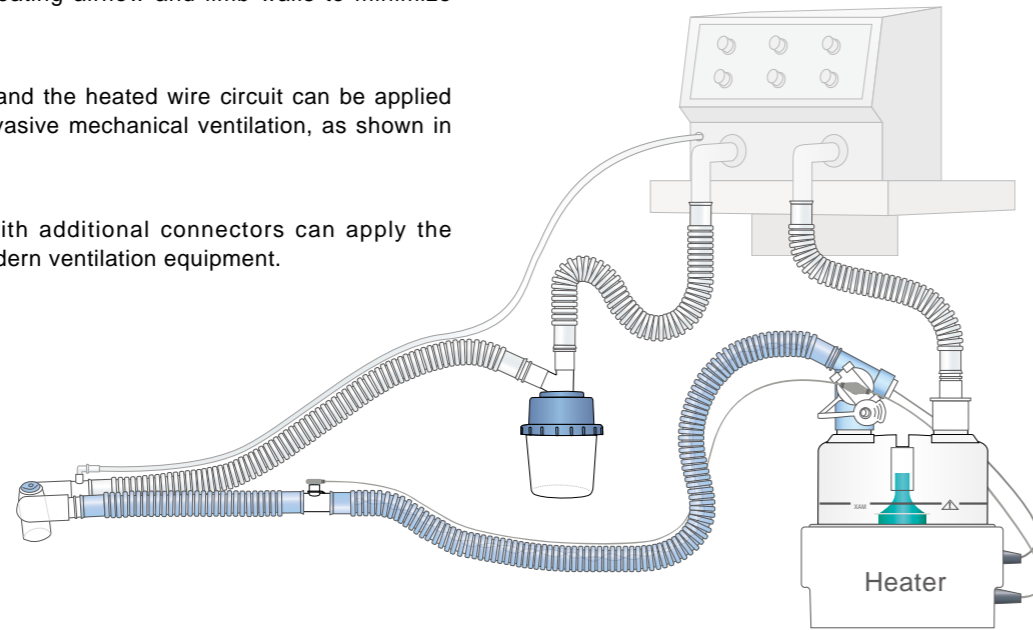

Dual Limb Heated Wire Circuit

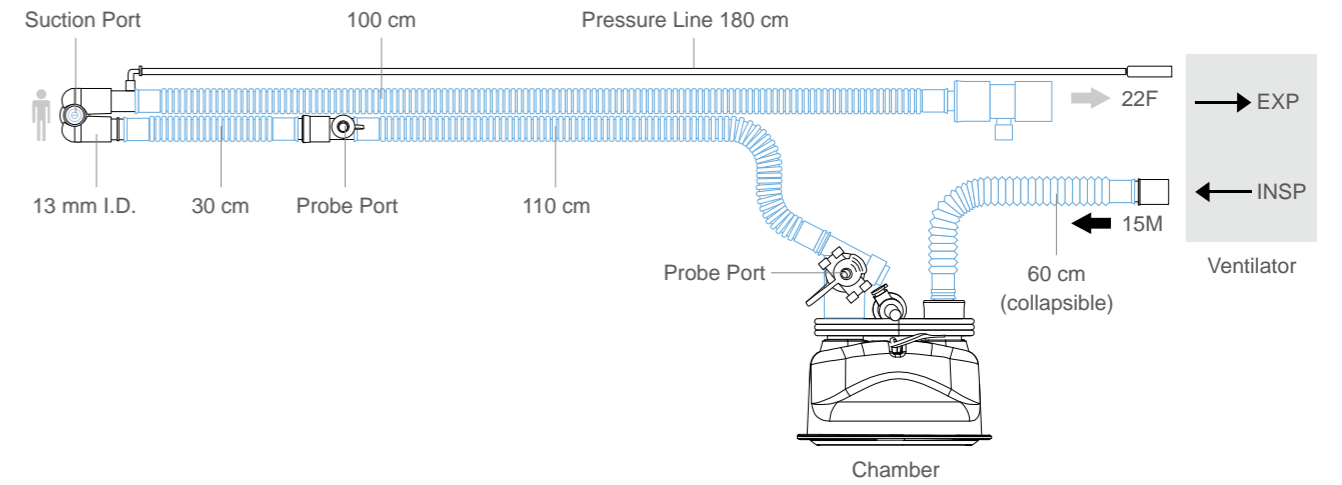

Infant Dual Limb Heated Wire Circuit contains both heated inspiratory limb and heated expiratory limbs, designed to be used with invasive mechanical ventilation (IMV) or non-invasive ventilation (NIV) with or without humidification chamber. With 10 mm I.D. connectors and a wye connector, the Dual Limb Heated Wire Circuit is available for connection of **Babi.Plus®** nCPAP prongs or other applicable products.

REF	Description	Chamber	QTY
AH0015	HW2 Circuit, Infant	N/A	10 pcs/carton
AH0016	HW2 Circuit, Infant w/Chamber	●	10 pcs/carton

### Single Limb Heated Wire Circuit

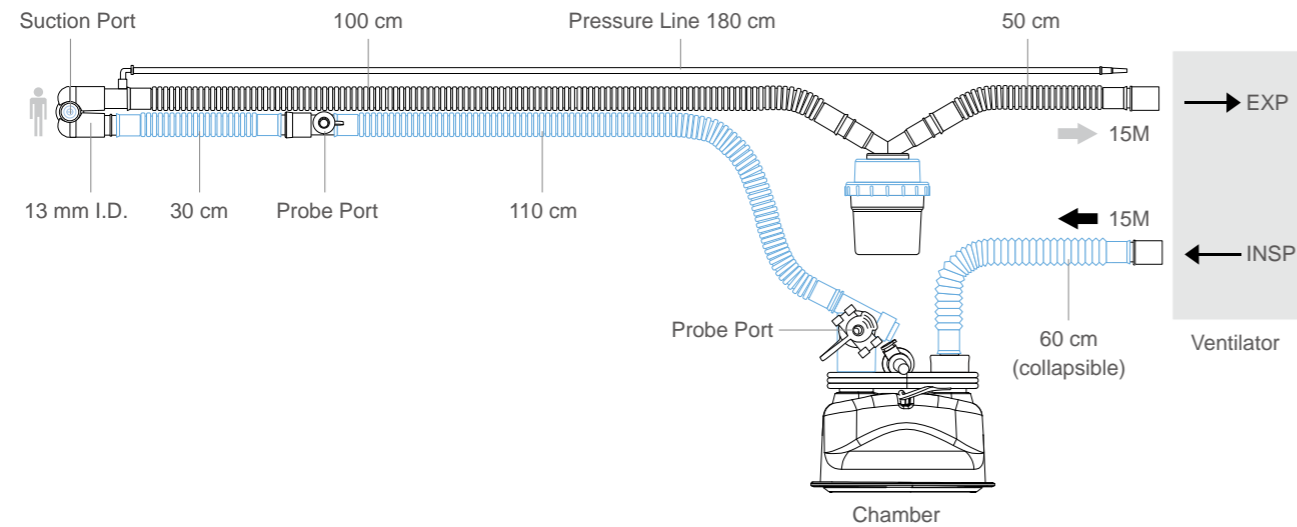

#### Standard Type

Infant single limb heated wire circuit (standard type) contains a heated inspiratory limb and was designed to be used with invasive mechanical (IMV) or non-invasive ventilation (NIV). With an inner 10 mm ID connector and wye connector, the infant single limb heated wire circuit (standard type) is connected to the **Babi.Plus®** nBubble CPAP or other applicable products. Infant single limb heated wire circuit can be with or without humidification chamber.

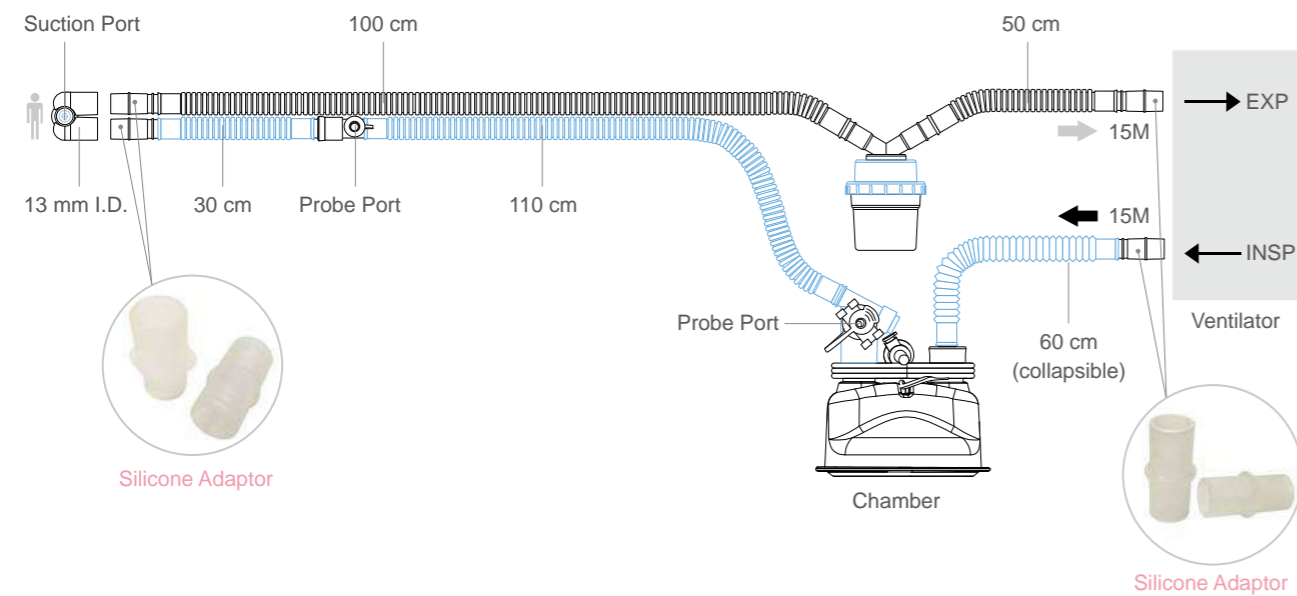

#### Dräger Type (DR Type)

The DR Type circuit is designed for **Dräger™** ventilators. The DR Type circuit contains all silicone adaptors. Due to the design of the ventilator, the pressure line is excluded.

### Single Limb Heated Wire Circuit

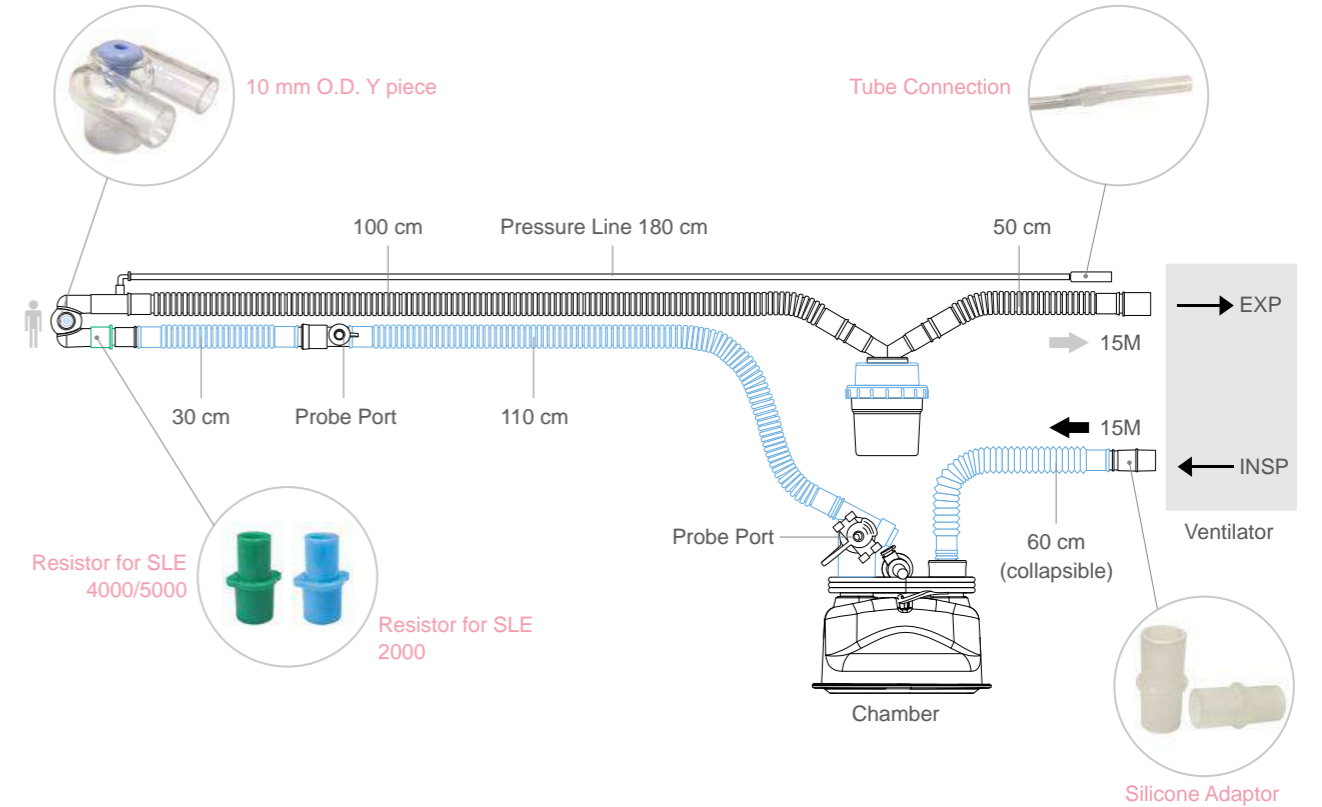

#### SLE Type

The SLE Type circuit is designed for SLE ventilator. The SLE Type circuit contains adaptors and a resistor.

REF	Description	Application	Chamber	QTY
AH0011	HW1 Circuit, Infant w/WT	Standard	N/A	10 pcs/carton
AH0012	HW1 Circuit, Infant w/WT, Chamber	Standard	●	10 pcs/carton
AH0063	HW1 Circuit, Infant for DR	Dräger Babylog	N/A	10 pcs/carton
AH0013	HW1 Circuit, Infant w/Chamber for DR	Dräger Babylog	●	10 pcs/carton
AH0064	HW1 Circuit, Infant for SLE	SLE 4000/5000	N/A	10 pcs/carton
AH0014	HW1 Circuit, Infant w/Chamber for SLE	SLE 4000/5000	●	10 pcs/carton
AH0070	HW1 Circuit, Infant, SLE	SLE 2000	●	10 pcs/carton

### Connector Kit

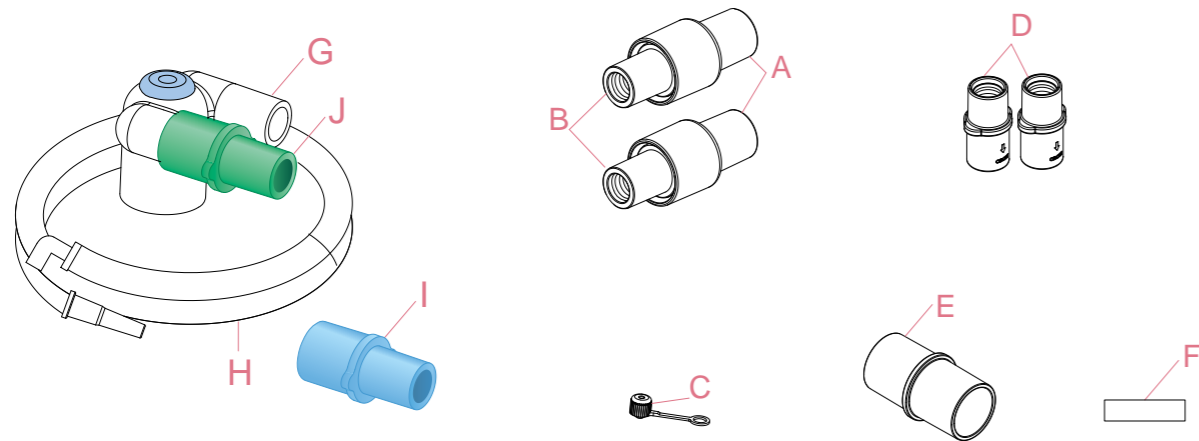

Two Connector Kit options offer comprehensive solutions for breathing circuit connections with a variety of connectors, tubes, pressure monitoring line, and adaptors. The Connector Kits allow versatility to diverse ventilators and/or anesthesia machines, which feature resistors for specific ventilators (SLE 2000 or 4000/5000) that require resistance conditions.

REF	Description	QTY
AC0231	Connector Kit, Infant w/ Resistor #1, Green	100 pcs/carton
AC0232	Connector Kit, Infant w/ Resistor #0, Blue, Resistor #1, Green	100 pcs/carton

#### SPECIFICATION

Item	Descriptions	AC0231	AC0232
A	(2) Connector, 22 mm I.D., 15 mm I.D.	●	●
B	(2) Silicone Connector, 10 mm I.D., 12 mm I.D.	●	●
C	(1) Pressure Port Luer Cap, 4.3 mm O.D.	●	●
D	(2) Silicone Connector, 10 mm I.D., 10 mm I.D.	●	●
E	(1) Connector, 22 mm O.D., 22 mm O.D.	●	●
F	(1) Silicone Pressure Line Connector, 5 mm I.D.	●	●
G	(1) Wye Connector, 15 mm I.D., 10 mm O.D., 10 mm O.D.	●	●
H	(1) Pressure Line, 3.5 mm I.D.	●	●
I	(1) Resistor, #1, Green, 10 mm O.D., 10 mm I.D.. Resistance: ≈4.5 cmH <sub>2</sub> O @ 2.5 LPM. Applicable on SLE 4000/5000.	●	●
J	(1) Resistor, #0, Blue, 10 mm O.D., 10 mm I.D.. Resistance: ≈6.4 cmH <sub>2</sub> O @ 2.5 LPM. Applicable on SLE 2000.	N/A	●

### Auto Feeding Chamber



Auto-feeding humidification chamber is an upgrade design of a conventional one to improve the quality of respiratory care. The **Humi.AIDE™** Auto Feeding Chamber features a sensitive auto-filling mechanism for accurate water level control, which allows sterile water to fill into the chamber automatically without interruption of airflow and ventilation. It can also reduce the time of frequently monitoring by clinicians and the patients' risk of cross-contamination.

REF	Description	QTY
AH0038	Auto Chamber, Infant	12 pcs/carton



## Heated Humidifier (5D and 5A)

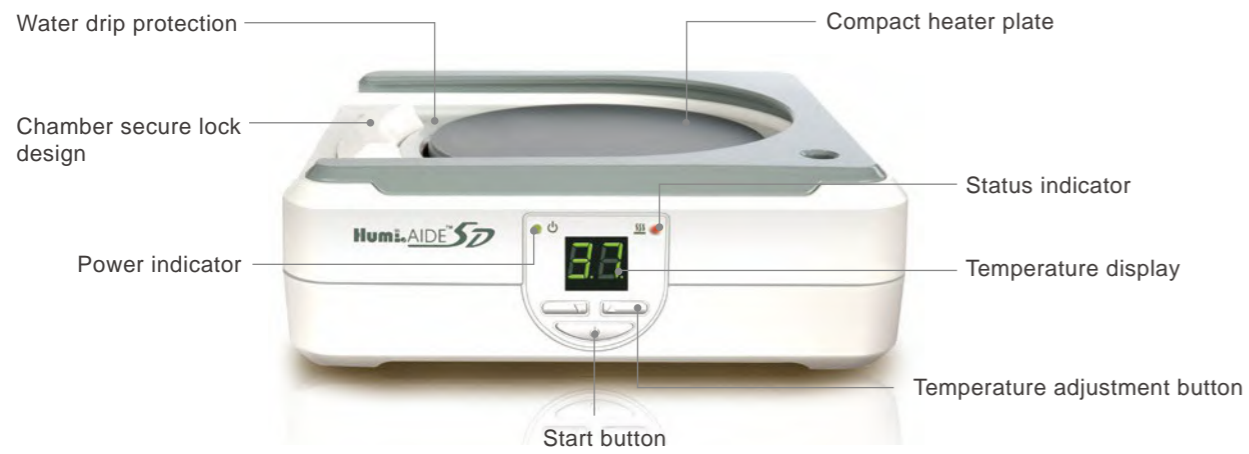

**Humi.AIDE™** 5D and 5A Humidifiers are the ideal humidification choice for a non-heated wire breathing system. These are easy-to-use devices, especially for homecare and long-term care facilities. **Humi.AIDE™** 5D and 5A Humidifiers contain overheat protection to ensure patient safety. Various applications are depicted in Figure A and B.

**Humi.AIDE™ 5D: Digital Type**



**Humi.AIDE™ 5A: Analog Type**

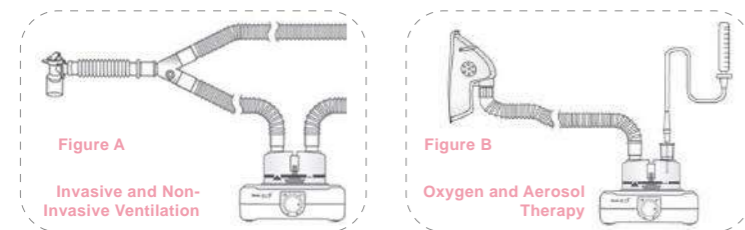

## Oxygen Support



REF	Description	Type	Operating Voltage	Frequency	QTY
AQ0019	H5D Humidifier, 120 V	Digital	100-120 V AC	60 Hz	10 pcs/carton
AQ0020	H5D Humidifier, 240 V	Digital	220-240 V AC	50-60 Hz	10 pcs/carton
AQ0002	H5D Temperature Probe, 1.6 m (Accessories, not included in the set)				10 pcs/box
AQ0017	H5A Humidifier, 120 V	Analog	100-120 V AC	60 Hz	10 pcs/carton
AQ0018	H5A Humidifier, 240 V	Analog	220-240 V AC	50-60 Hz	10 pcs/carton

Oxi.Hood 

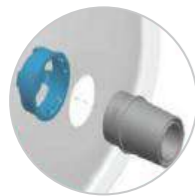

**Inlet Port Diverter**  
Prevent direct oxygen flowing onto the baby. 15/22 mm connector is compatible with various types of oxygen supply



**Tubing Port**  
Raised base port allows convenient tubing and line placement



**Weight Bar**  
Provide stable hood fixation by simply placing weight bar in the groove



**Padded Neck Hole**  
Ergonomic design optimally accommodates all ranges of babies' heads

**Oxi.Hood** features simple operations and functional designs, offering a practical solution for neonatal oxygen administration and temperature maintenance. Transparent hood shell provides a clear view of the baby, ensuring continuous safety monitoring. Weight bar and groove designs secure the hood in position. **Oxi.Hood** is available in 3 sizes to provide a better fit for premature and neonate, and each set comes with a hood and two weight bars.

REF	Description	Head (Length x Width x Height)	Neck (Width x Height)	QTY
AO0031	Oxi.Hood, S (included 2 pcs Weight Bar)	19 x 18 x 15 cm	7 x 5 cm	10 pcs/box
AO0033	Oxi.Hood, M (included 2 pcs Weight Bar)	19 x 18 x 15 cm	10 x 7 cm	10 pcs/box
AO0034	Oxi.Hood, L (included 2 pcs Weight Bar)	22 x 21 x 18 cm	12 x 10 cm	10 pcs/box
AO0032	Weight Bar for Oxi.Hood (Accessories)	-	-	2 pcs/box



Test Lung



## nTest Lung



**Babi.Plus®** nTest Lung is an easy test device which simulates pulmonary physiology. It intended for use of demonstration and testing applications with neonatal ventilation systems. Each nTest Lung set includes a strap, two bracket test lungs and a carrying pouch. Various resistance of single test lungs (with or without bracket) are available for assembling the desired lung simulation.



REF	Description	Content	QTY
AN0004	nTest Lung, R145x2	A strap, two bracket test lungs, a carrying pouch	10 pcs/box
AB0051	nTest Lung Module, R90	One test lung without bracket	24 pcs/carton
AB0052	nTest Lung Module, R600	One bracket test lung	24 pcs/carton
AB0053	nTest Lung Module, R300	One bracket test lung	24 pcs/carton
AB0054	nTest Lung Module, R145	One bracket test lung	24 pcs/carton
AB0055	nTest Lung Module, R90	One bracket test lung	24 pcs/carton



Others



## Pole Clamp



### Dual Pole Clamp

Durable and intend to support a total weight of ≤10 kg of two products on an equipment pole



### Single Pole Clamp

Intend to support a weight of ≤3 kg on an equipment pole



Pole Clamps are ISO 19054 compliant and available for poles 2.0 to 3.2 cm in diameter, providing sturdy mounting of the **Babi.Plus®** Bubble PAP valve, humidifiers or other devices.

REF	Description	QTY
AB0223	ISO Pole Clamp, Dual, Aluminum	10 pcs/mid box
AB0222	ISO Pole Clamp, Single	10 pcs/mid box

## Manual Percussor

Manual percussor is an airway management device assisting with chest physiotherapy. It offers a convenient alternative to manual chest percussion via "hand cupping" with unique manual percussor cups, allowing caregivers to perform chest percussion with manual pounding or clapping to loosen secretions.

- AW0056 Manual Percussor, S
- AW0057 Manual Percussor, M

Package: 48 pcs/carton



## GiO™ Manometer



GB10 **GiO™** Manometer is packaged with the following:

- One GB10 **GiO™** Manometer with a Lithium Cell
- Two Disposable Pressure Line with Luer-type Connectors
- Two Hydrophobic Filters
- One Additional Lithium Cell
- Two Elbow Connectors
- One Straight Connector
- One Silicone Pressure Line 50 cm



**GiO™** Manometer offers a simple method for bedside pressure measurement with real time display in both analogue bar and digital reading. Easy operation starting with only two buttons (Power ON/OFF and P&H Button) brings high efficiency to healthcare. **GiO™** Manometer GB10 measures pressure between 0~30 cmH<sub>2</sub>O for both non-invasive and invasive infant/neonatal applications.

REF	Description	QTY
AQ0008	GiO Manometer, 0~30 cmH <sub>2</sub> O	10 pcs/big box
AF0003	Filter, Hydrophobic, 7.6M, Luer (Accessories)	50 pcs/carton
AC0091	L Connector, 7.6M, 4B, PSF, Amber (Accessories)	5 pcs/box
AC0090	L Connector, 7.6M, 6M, PSF, Amber (Accessories)	5 pcs/box
AC0212	Connector, 7.6M, Luer, PSF (Accessories)	5 pcs/box
AB0061	Gas Sampling Line, 50 cm, 4M, 4M (Accessories)	50 pcs/carton



## Clean & Sterilization

### MATERIALS USED FOR GALEMED PRODUCTS:





Single patient use or disposable items are prohibited to be reused.  
Reusable items are treated as below:

Material	Autoclave 134°C	EtO gas	Liquid Sterilizer
ABS	Distort	Yes	Yes
Polycarbonate (PC)	Distort	Yes	Excellent
Polyethylene (PE )	Marginal to poor	Yes	Excellent
Polypropylene (PP)	Yes	Yes	Excellent
Polysulfone	Excellent	Yes	Excellent
PVC	Marginal to poor	Yes	Distort
Silicone rubber	Yes	Yes	Excellent
Stainless, Aluminum	Excellent	Yes	Excellent
Rubber	Distort	Yes	Yes

### CLEANING & STERILIZATION STEPS:

- 1 Disassemble the product as per the IFU, if necessary.
- 2 Wash components thoroughly in lukewarm water with a mild detergent which shall be compatible with the material of the device.
- 3 Rinse the components thoroughly in lukewarm water to remove all traces of detergent.
- 4 Sterilize the components using one of the following methods:
  - a. Autoclaved (max 134°C /273°F).
  - b. Ethylene oxide.
  - c. The most common disinfecting solution is used the equipment coming from the contact with the patient. Rinse thoroughly with water after sterilization.
- 5 Dry all components thoroughly after sterilization.
- 6 Inspect all components prior to usage; if any tear or any damage, please replace it.
- 7 Repack properly after usage to avoid any contamination.

#### Symbol Guide For This Catalog

 <b>Do not reuse</b> To indicate that the product is for single use only.	 Indicates that natural rubber latex was not used in the manufacturing of the product, its container, or its packaging.	 Sterilizable in a steam sterilizer (autoclave) at temperature 121°C (250°F) will be accepted
 Indicates that product that does not contain the phthalate plasticizer DEHP.	 Sterilizable in a steam sterilizer (autoclave) at temperature 134°C (273°F) will be Sterilizable	

Date / /

---



---



---



---



---



---



---



---



---



---



---



---



---



---



---



---



---



---



---



---



---



---



**AP2 UG (haftungsbeschränkt)**  
 Erich-Ollenhauer-Str.12  
 51377 Leverkusen  
 Handelsregister: HRB 111772 Registergericht: Amtsgericht Köln  
 Vertreten durch: Paul Stamirski, Anton Zirnow  
 Telefon: +49 (0) 214 690 58 414  
 Email: info@ap2.tech